

# LODES



P.	PRODUCT NAME
	Suspension lamps:
003	Axia <b>NEW</b>
004	Cima
005	Elara
006	IVY V
007	JIM
008	Kelly dome
009	Kelly sphere
010	Non Random <b>NEW</b>
012	Random Cloud
020	Random Stick <b>NEW</b>
034	Sky-Fall <b>NEW</b>
035	Sky-Fall Round <b>NEW</b>
032	Tidal
037	Volum 42
	Cluster suspension lamps:
039	A-Tube
040	A-Tube Nano <b>NEW</b>
042	A-Tube Nano Duo
042	Cono di Luce
043	IVY I
044	Jefferson
044	JIM
046	Kelly Cluster
046	Nostalgia
048	Oblò
049	Rain
050	Random
051	Random Five <b>NEW</b>
052	Random Solo
058	Spider
059	Volum 14, 22, 29
	Canopies:
060	Single canopies <b>NEW</b>
062	Multiple canopies <b>NEW</b>

P.	PRODUCT NAME
	Wall & Ceiling lamps:
072	Aile
069	A-Tube
070	A-Tube Nano Swing <b>NEW</b>
072	Bugia
074	Laser
075	Nautilus
076	Nautilus Mini
077	Nautilus Spot
077	Pin-Up
079	Puzzle
080	Puzzle Mega
078	Puzzle Round
086	Shift
083	Spider
084	Tidal 45, 60
085	Tidal 75
087	Volum
	Floor & Table lamps:
095	Blow
091	Cima
096	Cono di Luce
092	Croma
097	Easy Peasy
093	Flar
094	Hover
098	Volum table
100	Volum floor
	Systems:
102	DOUBLEZERO7 <b>NEW</b>
124	MAP
130	Accessories

## Lodes Price List

ED. 2026

# Suspension lamps

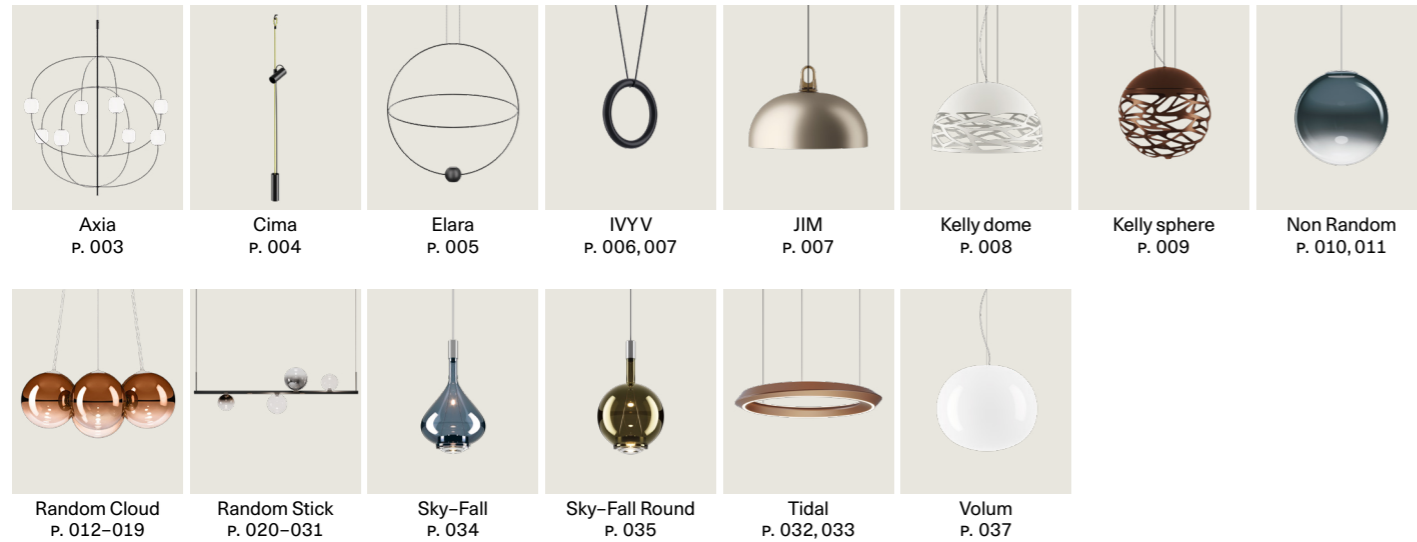

CATEGORY **SUSPENSION LAMP** **NEW**

Axia

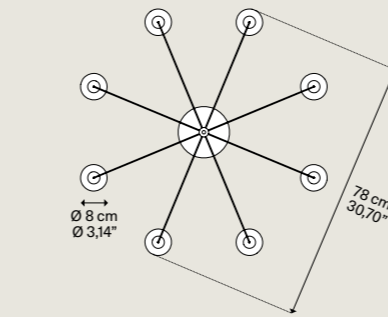
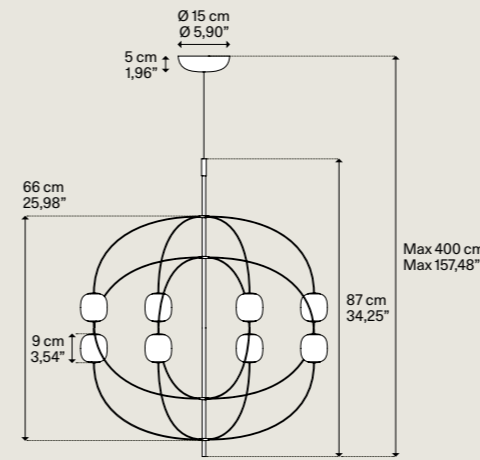

Net weight	2,65 kg	Pack	1	Energy class	D
Peso netto	5,84 lbs	Colli		Classe energetica	

DESIGN Vittorio Venezia and Carolina Martinelli, 2026

VAT excluded  
IVA esclusa

Stainless steel structure  
Montatura in acciaio inoss.

Blown glass diffuser  
Diffusore in vetro soffiato

Code  
Codice

A

Code  
Codice

B

Euro €

Black Chrome  
Cromo Nero

Frosted White  
Bianco Satinato

25121 2227

25121 2230

1.080,00

Glossy Bronze  
Bronzo Lucido

25121 4627

25121 4630

1.080,00

Light source  
Sorgente luminosa

Light source  
Sorgente luminosa

LED  
2700 K  
3510 lm  
24 V  
CRI 90  
MacAdam 3-Step

LED  
3000 K  
3570 lm  
24 V  
CRI 90  
MacAdam 3-Step

LED and driver included  
LED e driver inclusi

LED and driver included  
LED e driver inclusi

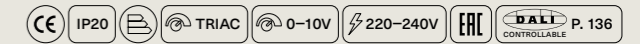

SUSPENSION LAMP  
CLUSTER SUSPENSION LAMP  
CANOPY  
WALL & CEILING LAMP  
FLOOR & TABLE LAMP  
SYSTEM  
ACCESSORY

# Cima

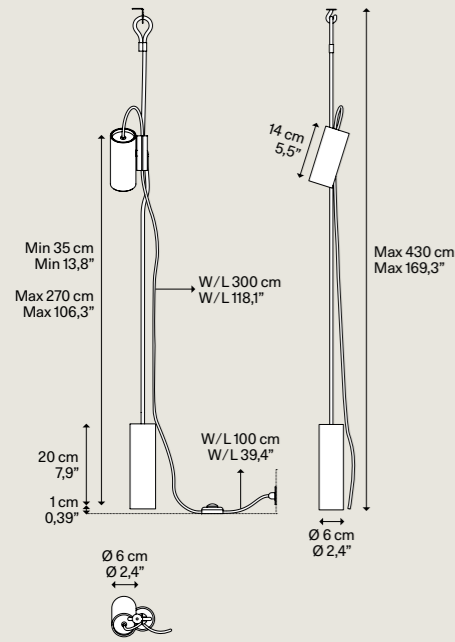

Metal structure Montatura in metallo	Rope Corda	Code Codice	Euro €
● Matte Black Nero Opaco	● Silver Argento	17371 4100	304,00
	● Gold Oro	17371 5000	304,00
	● Yellow Giallo	17371 5100	304,00

**Light source**  
Sorgente luminosa

**GU10 Par 16 LED** W/L max 9 cm  
**1 × 10 W** W/L max 3,54"

Bulb and dimmer not included  
Lampadina e dimmer non inclusi

Description Descrizione	Metal structure Montatura in metallo	Code Codice	Euro €
Additional kit (max 1 additional kit).	● Matte Black Nero Opaco	17371K 2000	199,00

**Light source**  
Sorgente luminosa

**GU10 Par 16 LED** W/L max 9 cm  
**1 × 10 W** W/L max 3,54"

Bulb and dimmer not included  
Lampadina e dimmer non inclusi

Net weight 1,75 kg  
Peso netto 3,86 lbs

Pack Colli 1



## Adjustable light Luce orientabile

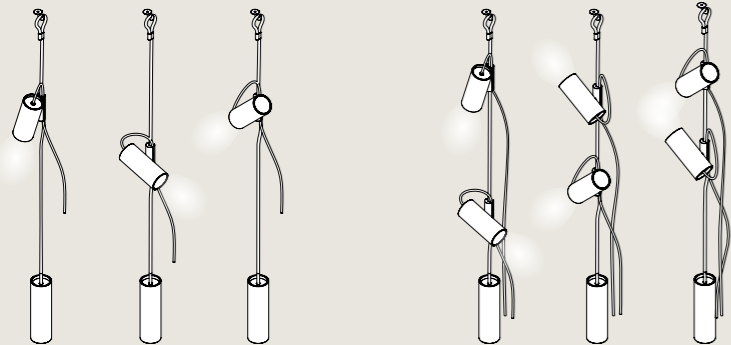

# Elara medium

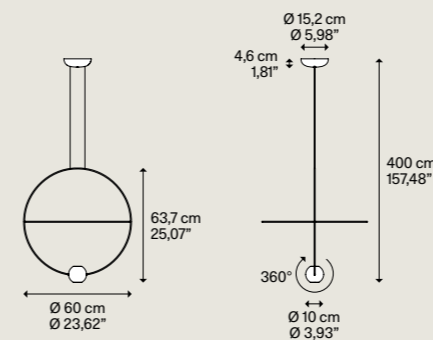

Metal structure Montatura in metallo	Metal sphere Sfera in metallo	Code Codice	Code Codice	Euro €
● Glossy Black Nero Lucido	● Extra Matte Black Nero Extra Opaco	20621 2227	20621 2230	663,00
● Glossy Gold Oro Lucido	● Matte Gold Oro Opaco	20621 5027	20621 5030	796,00

**Light source**  
Sorgente luminosa

**LED** K  
**2700** W  
**18+9** Im-side I  
**2100** Im-side II  
**800** mA  
**1000** mA  
**CRI 90**  
**MacAdam 3-Step**

LED and driver included  
LED e driver inclusi

**Light source**  
Sorgente luminosa

**LED** K  
**3000** W  
**18+9** Im-side I  
**2260** Im-side II  
**845** mA  
**1000** mA  
**CRI 90**  
**MacAdam 3-Step**

LED and driver included  
LED e driver inclusi

Net weight 1,67 kg  
Peso netto 3,68 lbs

Pack Colli 1

Energy class 2700 K ▶D+E  
Classe energetica 3000 K ▶D+F



# Elara large

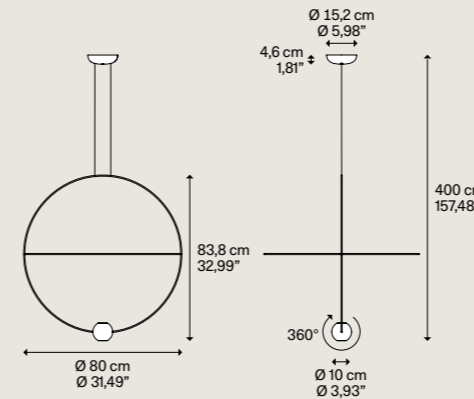

Metal structure Montatura in metallo	Metal sphere Sfera in metallo	Code Codice	Code Codice	Euro €
● Glossy Black Nero Lucido	● Extra Matte Black Nero Extra Opaco	20622 2227	20622 2230	806,00
● Glossy Gold Oro Lucido	● Matte Gold Oro Opaco	20622 5027	20622 5030	969,00

**Light source**  
Sorgente luminosa

**LED** K  
**2700** W  
**18+9** Im-side I  
**2100** Im-side II  
**800** mA  
**1000** mA  
**CRI 90**  
**MacAdam 3-Step**

LED and driver included  
LED e driver inclusi

**Light source**  
Sorgente luminosa

**LED** K  
**3000** W  
**18+9** Im-side I  
**2260** Im-side II  
**845** mA  
**1000** mA  
**CRI 90**  
**MacAdam 3-Step**

LED and driver included  
LED e driver inclusi

Net weight 1,87 kg  
Peso netto 4,12 lbs

Pack Colli 1

Energy class 2700 K ▶D+E  
Classe energetica 3000 K ▶D+F

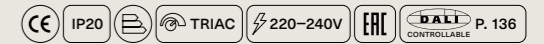

## Adjustable light Luce orientabile

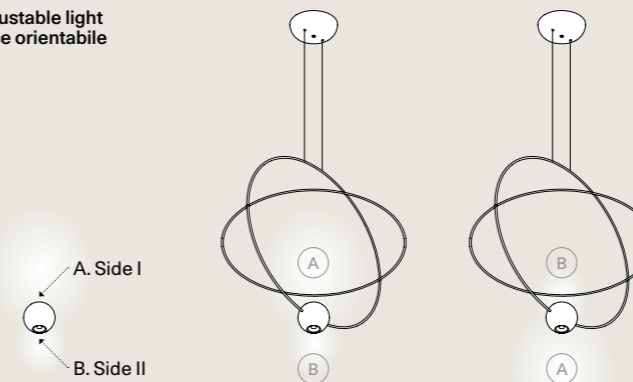

## Adjustable ring Anello orientabile

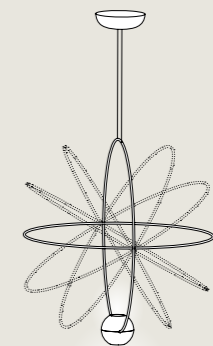

CATEGORY CENTRAL CLUSTER SUSPENSION LAMP

DESIGN Vittorio Massimo, 2022

VAT excluded IVA esclusa

IVYV

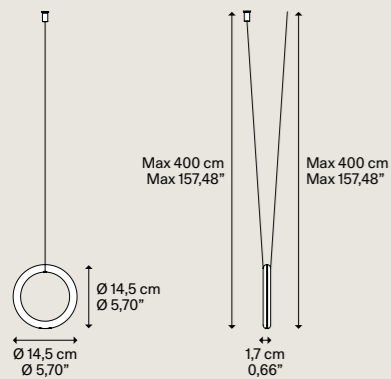

Metal structure Montatura in metallo	Cable Cavo	Code Codice	Code Codice	Euro €
● Matte Black – 9005 Nero Opaco – 9005	Ⓛ Black Nero	17820 2020	17820 2035	199,00
● Extra Matte Champagne Champagne Extr. Opaco		17820 4520	17820 4535	210,00
● Extra Matte Terra Terra Extra Opaco		17820 6720	17820 6735	220,00

Light source Sorgente luminosa	
<b>LED</b>	<b>K</b>
2700	3
450	350
350	350
CRI 90	
MacAdam 3-Step	
LED and driver included LED e driver inclusi	

Light source Sorgente luminosa	
<b>LED</b>	<b>K</b>
3000	3
480	350
350	350
CRI 90	
MacAdam 3-Step	
LED and driver included LED e driver inclusi	

Net weight Peso netto	0,58 kg 1,27 lbs	Pack Colli	1	Energy class Classe energetica	2700 K ▶ D 3000 K ▶ C
--------------------------	---------------------	---------------	---	-----------------------------------	--------------------------

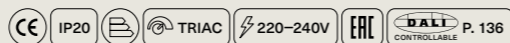

IVYV cluster suspension lamps must only be installed on the single and central canopies below  
Le lampade a sospensione cluster IVYV devono essere installate solamente sui rosoni singoli e centrali di seguito

CATEGORY SINGLE CANOPY

VAT excluded IVA esclusa

Single Mini

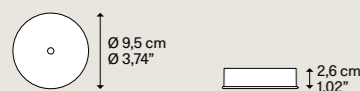

Description Descrizione	Methacrylate structure Struttura in metacrilato	Installation Installazione	Code Codice	Euro €
Surface-mounted canopy for a single pendant, with a maximum load capacity of 3,5 kg – 7,71 lbs.	● Matte Black – 9005 Nero Opaco – 9005	Single	R11L01 2000	43,00

Rosone a superficie per lampada singola, con portata massima di 3,5 kg – 7,71 lbs.

Net weight Peso netto	0,13 kg 0,28 lbs	Pack Colli	1
--------------------------	---------------------	---------------	---



CATEGORY RECESSED CANOPY

VAT excluded IVA esclusa

Recessed Micro

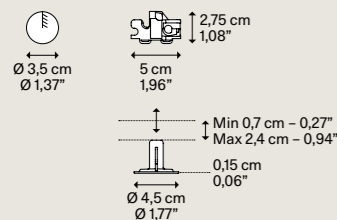

Description Descrizione	Methacrylate structure Struttura in metacrilato	Installation Installazione	Code Codice	Euro €
Recessed canopy for single pendant, with a maximum load capacity of 3,5 kg – 7,71 lbs. Suitable for false ceilings up to 2,4 cm – 0,94" thick.	● Matte Black – 9005 Nero Opaco – 9005	Recessed	R01L01 2000	26,00

Rosone da incasso per lampada singola, con portata massima di 3,5 kg – 7,71 lbs. Adatto a controsoffitti con spessore fino a 2,4 cm – 0,94".

Net weight Peso netto	0,015 kg 0,033 lbs	Pack Colli	1
--------------------------	-----------------------	---------------	---



Recessed Micro Trimless

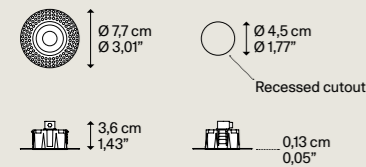

Description Descrizione	Methacrylate structure Struttura in metacrilato	Installation Installazione	Code Codice	Euro €
Trimless recessed canopy for a single pendant available in Pure and Deep versions, with a maximum load capacity of 3,5 kg – 7,71 lbs. Suitable for false ceilings up to 2,2 cm – 0,85" thick.	● Matte Black – 9005 Nero Opaco – 9005	Recessed	R13L01 2000	28,00

Rosone da incasso trimless in versione Pure e Deep per lampada singola, con portata massima di 3,5 kg – 7,71 lbs. Adatto a controsoffitti con spessore fino a 2,2 cm – 0,85".

Net weight Peso netto	0,12 kg 0,26 lbs	Pack Colli	1
--------------------------	---------------------	---------------	---



CATEGORY CENTRAL CANOPY

VAT excluded IVA esclusa

6 Lights Central

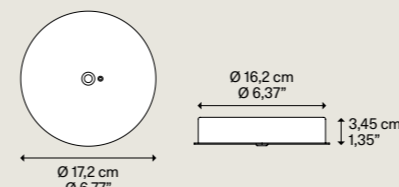

Net weight Peso netto	0,58 kg 1,27 lbs	Pack Colli	1
--------------------------	---------------------	---------------	---



12 Lights Central

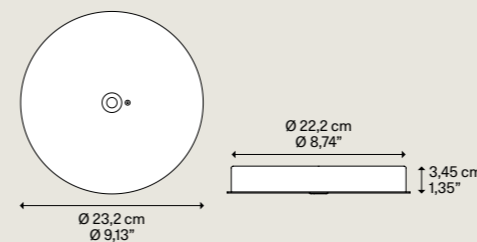

Net weight Peso netto	1,00 kg 2,20 lbs	Pack Colli	1
--------------------------	---------------------	---------------	---



Description Descrizione	Metal structure Struttura in metallo	System Sistema	Code Codice	Euro €
Central canopy for up to 6 suspensions.	● Matte Black – 9005 Nero Opaco – 9005	Cluster Central	R07L06 2000	148,00

Rosone Central per un massimo di 6 sospensioni.

VAT excluded IVA esclusa

Description Descrizione	Metal structure Struttura in metallo	System Sistema	Code Codice	Euro €
Central canopy for up to 12 suspensions.	● Matte Black – 9005 Nero Opaco – 9005	Cluster Central	R07L12 2000	200,00

Rosone Central per un massimo di 12 sospensioni.

VAT excluded IVA esclusa

CATEGORY SUSPENSION LAMP

DESIGN Patrick Norguet, 2021

VAT excluded IVA esclusa

JIM dome \*

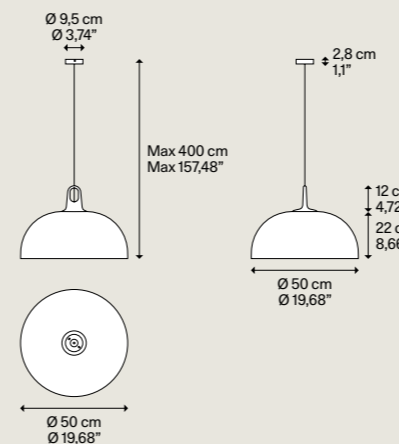

Net weight Peso netto	2,20 kg 4,85 lbs	Pack Colli	2
--------------------------	---------------------	---------------	---

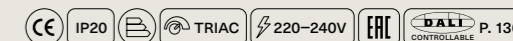

Outside metal diffuser Diff. esterno in metallo	Inside metal diffuser Diff. interno in metallo	Hook methacrylate Gancio in metacrilato	Code Codice	Euro €
● Matte White – 9010 Bianco Opaco – 9010	● Matte White – 9010 Bianco Opaco – 9010	● Grey Grigio	16924 2300	516,00
		● Honey Miele	16924 6300	516,00
		● Grey Grigio	16924 2800	516,00
● Matte Black – 9005 Nero Opaco – 9005	● Matte White – 9010 Bianco Opaco – 9010	● Honey Miele	16924 6600	516,00
		● Grey Grigio	16924 2700	526,00
● Matte Champagne Champagne Opaco	● Matte White – 9010 Bianco Opaco – 9010	● Honey Miele	16924 6500	526,00
		● Grey Grigio	16924 2400	526,00
● Coppery Bronze Bronzo Ramato	● Matte White – 9010 Bianco Opaco – 9010	● Honey Miele	16924 6400	526,00

Light source  
Sorgente luminosa

E27 A60 LED  
1x Max 25 W

Bulb not included  
Lampadina non inclusa

\* Available while stocks last.

\* Disponibile fino ad esaurimento scorte.

### Kelly small dome 50

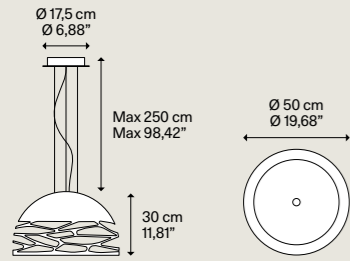

Net weight 6,00 kg  
Peso netto 13,22 lbs  
Pack Colli 1

Metal structure Montatura in metallo	Glass diffuser Diffusore in vetro	Code Codice	Euro €
Matte White -9010 Bianco Opaco -9010		14126 1000	600,00
Natural Brown NCS S 8005-Y50R NEW Testa di Moro NCS S 8005-Y50R	Glossy White Bianco Lucido	14126 6900	637,00
Matte Champagne Champagne Opaco		14126 4500	637,00

**Light source  
Sorgente luminosa**  
E27 LED 3x 25 W  
W/L max 12 cm  
W/L max 4,72"  
Bulb not included  
Lampadina non inclusa

CE IP20 TRIAC 220-240V ENEC DALI CONTROLLABLE P. 136

### Kelly small sphere 40 \*

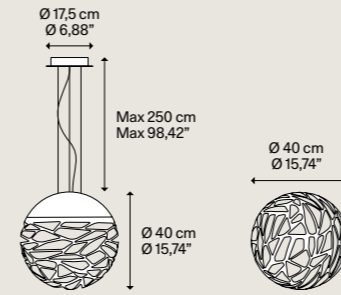

Net weight 5,50 kg  
Peso netto 12,13 lbs  
Pack Colli 2

Metal structure Montatura in metallo	Glass diffuser Diffusore in vetro	Code Codice	Euro €
Coppery Bronze Bronzo Ramato	Glossy White Bianco Lucido	14122 3500	939,00

**Light source  
Sorgente luminosa**  
E27 LED 3x 25 W  
W/L max 12 cm  
W/L max 4,72"  
Bulb not included  
Lampadina non inclusa

CE IP20 TRIAC 220-240V ENEC DALI CONTROLLABLE P. 136

### Kelly medium dome 60

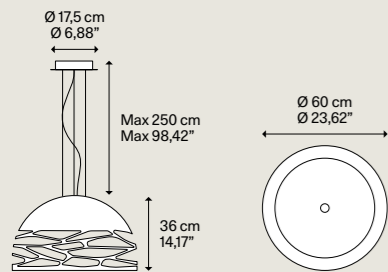

Net weight 7,15 kg  
Peso netto 15,76 lbs  
Pack Colli 1

Metal structure Montatura in metallo	Glass diffuser Diffusore in vetro	Code Codice	Euro €
Matte White -9010 Bianco Opaco -9010		14127 1000	927,00
Natural Brown NCS S 8005-Y50R NEW Testa di Moro NCS S 8005-Y50R	Glossy White Bianco Lucido	14127 6900	958,00
Matte Champagne Champagne Opaco		14127 4500	958,00

**Light source  
Sorgente luminosa**  
E27 LED 3x 25 W  
W/L max 12 cm  
W/L max 4,72"  
Bulb not included  
Lampadina non inclusa

CE IP20 TRIAC 220-240V ENEC DALI CONTROLLABLE P. 136

### Kelly medium sphere 50 \*

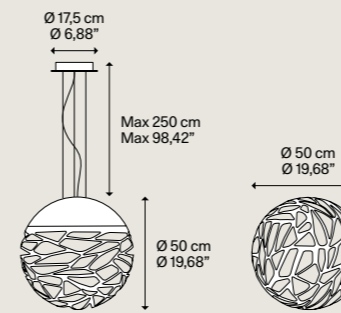

Net weight 9,00 kg  
Peso netto 19,84 lbs  
Pack Colli 2

Metal structure Montatura in metallo	Glass diffuser Diffusore in vetro	Code Codice	Euro €
Coppery Bronze Bronzo Ramato	Glossy White Bianco Lucido	14123 3500	1.240,00

**Light source  
Sorgente luminosa**  
E27 LED 3x 25 W  
W/L max 12 cm  
W/L max 4,72"  
Bulb not included  
Lampadina non inclusa

CE IP20 TRIAC 220-240V ENEC DALI CONTROLLABLE P. 136

### Kelly large dome 80

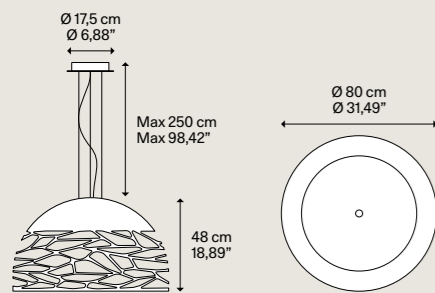

Net weight 11,00 kg  
Peso netto 24,25 lbs  
Pack Colli 1

Metal structure Montatura in metallo	Glass diffuser Diffusore in vetro	Code Codice	Euro €
Matte White -9010 Bianco Opaco -9010		14128 1000	1.157,00
Natural Brown NCS S 8005-Y50R NEW Testa di Moro NCS S 8005-Y50R	Glossy White Bianco Lucido	14128 6900	1.210,00
Matte Champagne Champagne Opaco		14128 4500	1.210,00

**Light source  
Sorgente luminosa**  
E27 LED 3x 25 W  
W/L max 12 cm  
W/L max 4,72"  
Bulb not included  
Lampadina non inclusa

CE IP20 TRIAC 220-240V ENEC DALI CONTROLLABLE P. 136

### Kelly large sphere 80 \*

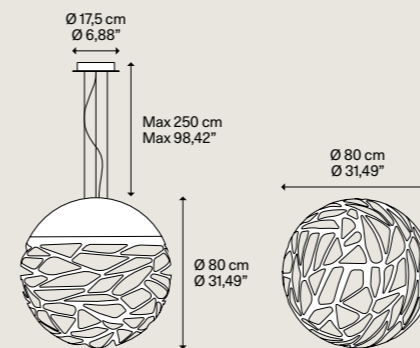

Net weight 15,00 kg  
Peso netto 33,07 lbs  
Pack Colli 2

Metal structure Montatura in metallo	Glass diffuser Diffusore in vetro	Code Codice	Euro €
Coppery Bronze Bronzo Ramato	Glossy White Bianco Lucido	14124 3500	3.326,00

**Light source  
Sorgente luminosa**  
E27 LED 3x 25 W  
W/L max 12 cm  
W/L max 4,72"  
Bulb not included  
Lampadina non inclusa

CE IP20 TRIAC 220-240V ENEC DALI CONTROLLABLE P. 136

\* Available while stocks last.

\* Disponibile fino ad esaurimento scorte.

### Non Random 33

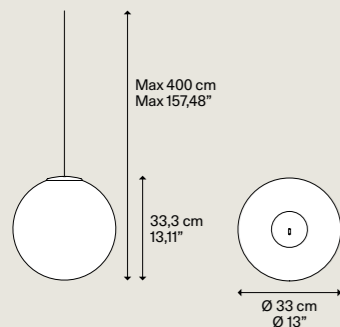

Blown glass diffuser Diffusore in vetro soffiato	Metal and technopolymer structure Struttura in metallo e tecnopolimero	Code Codice	Euro €
Clear Trasparente	Clear Trasparente	26011 0023	370,00
Glossy Smoke Fumo Lucido	Glossy Smoke Fumo Lucido	26011 4323	550,00
Glossy Bronze Bronzo Lucido	Glossy Bronze Bronzo Lucido	26011 4623	550,00
Mandarin Orange <b>NEW</b> Arancio Vivace	Mandarin Orange <b>NEW</b> Arancio Vivace	26011 5823	550,00
Golden Sage <b>NEW</b> Salvia Dorata	Golden Sage <b>NEW</b> Salvia Dorata	26011 7123	550,00
Deep Azure Steel <b>NEW</b> Azzurro Metallizzato Intenso	Deep Azure Steel <b>NEW</b> Azzurro Metallizzato Intenso	26011 8623	550,00

**Light source**  
Sorgente luminosa

LED  
Turnable White

7 W  
2200 K → 1214 lm  
2700 K → 1272 lm  
3000 K → 1330 lm  
350 mA  
CRI 90  
MacAdam 3-Step  
LED and driver included  
LED e driver inclusi

Net weight 1,15 kg / 2,53 lbs  
Pack Colli 2  
Energy class Classe energetica C



**NEW**

### Non Random 38

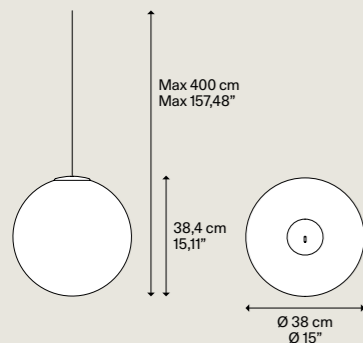

Blown glass diffuser Diffusore in vetro soffiato	Metal and technopolymer structure Struttura in metallo e tecnopolimero	Code Codice	Euro €
Clear Trasparente	Clear Trasparente	26012 0023	550,00
Glossy Smoke Fumo Lucido	Glossy Smoke Fumo Lucido	26012 4323	790,00
Glossy Bronze Bronzo Lucido	Glossy Bronze Bronzo Lucido	26012 4623	790,00
Mandarin Orange <b>NEW</b> Arancio Vivace	Mandarin Orange <b>NEW</b> Arancio Vivace	26012 5823	790,00
Golden Sage <b>NEW</b> Salvia Dorata	Golden Sage <b>NEW</b> Salvia Dorata	26012 7123	790,00
Deep Azure Steel <b>NEW</b> Azzurro Metallizzato Intenso	Deep Azure Steel <b>NEW</b> Azzurro Metallizzato Intenso	26012 8623	790,00

**Light source**  
Sorgente luminosa

LED  
Turnable White

7 W  
2200 K → 1214 lm  
2700 K → 1272 lm  
3000 K → 1330 lm  
350 mA  
CRI 90  
MacAdam 3-Step  
LED and driver included  
LED e driver inclusi

Net weight 1,30 kg / 2,86 lbs  
Pack Colli 2  
Energy class Classe energetica C



The lamps must be installed on single canopies ▶ P. 060-061 or on the DOUBLEZERO7 System ▶ P. 102-123  
Le lampade devono essere installate su rosoni singoli ▶ P. 060-061 o su sistema DOUBLEZERO7 ▶ P. 102-123

### Non Random 43

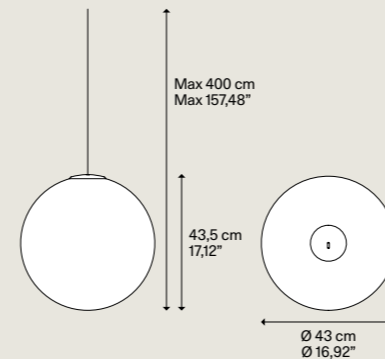

Blown glass diffuser Diffusore in vetro soffiato	Metal and technopolymer structure Struttura in metallo e tecnopolimero	Code Codice	Euro €
Clear Trasparente	Clear Trasparente	26013 0023	950,00
Glossy Smoke Fumo Lucido	Glossy Smoke Fumo Lucido	26013 4323	1.250,00
Glossy Bronze Bronzo Lucido	Glossy Bronze Bronzo Lucido	26013 4623	1.250,00
Mandarin Orange <b>NEW</b> Arancio Vivace	Mandarin Orange <b>NEW</b> Arancio Vivace	26013 5823	1.250,00
Golden Sage <b>NEW</b> Salvia Dorata	Golden Sage <b>NEW</b> Salvia Dorata	26013 7123	1.250,00
Deep Azure Steel <b>NEW</b> Azzurro Metallizzato Intenso	Deep Azure Steel <b>NEW</b> Azzurro Metallizzato Intenso	26013 8623	1.250,00

**Light source**  
Sorgente luminosa

LED  
Turnable White

7 W  
2200 K → 1214 lm  
2700 K → 1272 lm  
3000 K → 1330 lm  
350 mA  
CRI 90  
MacAdam 3-Step  
LED and driver included  
LED e driver inclusi

Net weight 1,90 kg / 4,18 lbs  
Pack Colli 2  
Energy class Classe energetica C



The lamps must be installed on single canopies ▶ P. 060-061 or on the DOUBLEZERO7 System ▶ P. 102-123  
Le lampade devono essere installate su rosoni singoli ▶ P. 060-061 o su sistema DOUBLEZERO7 ▶ P. 102-123

Random Cloud 7 Lights Ø23

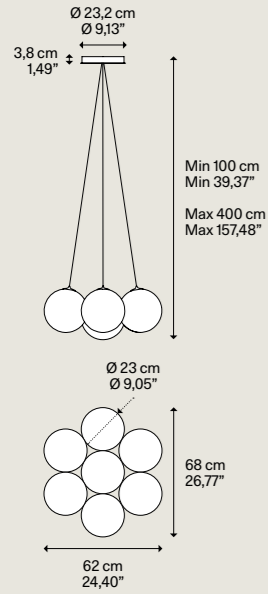

Blown glass diffuser Diffusore in vetro soffiato	Canopy, structure and cable Rosone, Struttura e cavo	Code Codice	A	Code Codice	B	Euro €
Clear Trasparente		22121 0027		22121 0030		1.839,00
Frosted White Bianco Satinato		22121 1327		22121 1330		2.693,00
Glossy Smoke Fumo Lucido		22121 4327		22121 4330		2.693,00
Pale Gold <b>NEW</b> Oro Chiaro	Canopy/Rosone	22121 4527		22121 4530		2.693,00
Glossy Bronze Bronzo Lucido	Matte White - 9010 Bianco Opaco - 9010	22121 4627		22121 4630		2.693,00
Mandarin Orange <b>NEW</b> Arancio Vivace	Silicone/Silicone	22121 5827		22121 5830		2.693,00
Golden Sage <b>NEW</b> Salvia Dorata	White Translucent Bianco translucido	22121 7127		22121 7130		2.693,00
Deep Azure Steel <b>NEW</b> Azzurro Met. Intenso	White cable Cavo Bianco	22121 8627		22121 8630		2.693,00
Clear Trasparente		22111 0027		22111 0030		1.839,00
Frosted White Bianco Satinato		22111 1327		22111 1330		2.693,00
Glossy Smoke Fumo Lucido		22111 4327		22111 4330		2.693,00
Pale Gold <b>NEW</b> Oro Chiaro	Canopy/Rosone	22111 4527		22111 4530		2.693,00
Glossy Bronze Bronzo Lucido	Matte Black - 9005 Nero Opaco - 9005 <b>NEW</b>	22111 4627		22111 4630		2.693,00
Mandarin Orange <b>NEW</b> Arancio Vivace	Silicone/Silicone	22111 5827		22111 5830		2.693,00
Golden Sage <b>NEW</b> Salvia Dorata	Matte Black Nero Opaco <b>NEW</b>	22111 7127		22111 7130		2.693,00
Deep Azure Steel <b>NEW</b> Azzurro Met. Intenso	Black cable Cavo Nero	22111 8627		22111 8630		2.693,00
<b>Light source</b> Sorgente luminosa	<b>Light source</b> Sorgente luminosa					
<b>A</b>	<b>B</b>					
LED	LED					
2700	3000					
K	K					
7x 3	7x 3					
W	W					
3150	3360					
lm	lm					
350	350					
mA	mA					
CRI 90	CRI 90					
MacAdam 3-Step	MacAdam 3-Step					
LED and driver included LED e driver inclusi	LED and driver included LED e driver inclusi					

Net weight 5,20 kg / Peso netto 11,46 lbs  
Pack Colli 15  
Energy class Classe energetica D



Random Cloud 7 Lights Ø28

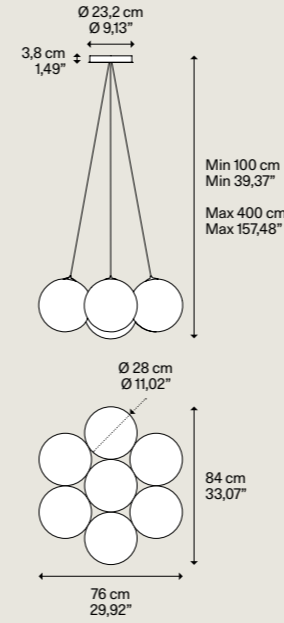

Blown glass diffuser Diffusore in vetro soffiato	Canopy, structure and cable Rosone, Struttura e cavo	Code Codice	A	Code Codice	B	Euro €
Clear Trasparente		22122 0027		22122 0030		2.126,00
Frosted White Bianco Satinato		22122 1327		22122 1330		2.980,00
Glossy Smoke Fumo Lucido		22122 4327		22122 4330		2.980,00
Pale Gold <b>NEW</b> Oro Chiaro	Canopy/Rosone	22122 4527		22122 4530		2.980,00
Glossy Bronze Bronzo Lucido	Matte White - 9010 Bianco Opaco - 9010	22122 4627		22122 4630		2.980,00
Mandarin Orange <b>NEW</b> Arancio Vivace	Silicone/Silicone	22122 5827		22122 5830		2.980,00
Golden Sage <b>NEW</b> Salvia Dorata	White Translucent Bianco translucido	22122 7127		22122 7130		2.980,00
Deep Azure Steel <b>NEW</b> Azzurro Met. Intenso	White cable Cavo Bianco	22122 8627		22122 8630		2.980,00
Clear Trasparente		22112 0027		22112 0030		2.126,00
Frosted White Bianco Satinato		22112 1327		22112 1330		2.980,00
Glossy Smoke Fumo Lucido		22112 4327		22112 4330		2.980,00
Pale Gold <b>NEW</b> Oro Chiaro	Canopy/Rosone	22112 4527		22112 4530		2.980,00
Glossy Bronze Bronzo Lucido	Matte Black - 9005 Nero Opaco - 9005 <b>NEW</b>	22112 4627		22112 4630		2.980,00
Mandarin Orange <b>NEW</b> Arancio Vivace	Silicone/Silicone	22112 5827		22112 5830		2.980,00
Golden Sage <b>NEW</b> Salvia Dorata	Matte Black Nero Opaco <b>NEW</b>	22112 7127		22112 7130		2.980,00
Deep Azure Steel <b>NEW</b> Azzurro Met. Intenso	Black cable Cavo Nero	22112 8627		22112 8630		2.980,00
<b>Light source</b> Sorgente luminosa	<b>Light source</b> Sorgente luminosa					
<b>A</b>	<b>B</b>					
LED	LED					
2700	3000					
K	K					
7x 3	7x 3					
W	W					
3150	3360					
lm	lm					
350	350					
mA	mA					
CRI 90	CRI 90					
MacAdam 3-Step	MacAdam 3-Step					
LED and driver included LED e driver inclusi	LED and driver included LED e driver inclusi					

Net weight 7,30 kg / Peso netto 16,09 lbs  
Pack Colli 15  
Energy class Classe energetica D

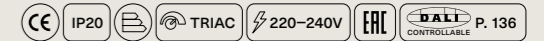

Random Cloud 14 Lights Ø23

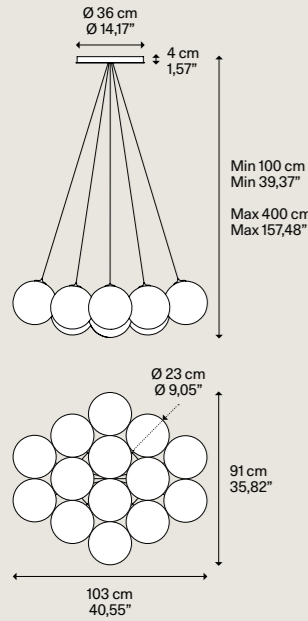

Blown glass diffuser  
Diffusore in vetro soffiato

- Clear  
Trasparente
- Frosted White  
Bianco Satinato
- Glossy Smoke  
Fumo Lucido
- Pale Gold **NEW**  
Oro Chiaro
- Glossy Bronze  
Bronzo Lucido
- Mandarin Orange **NEW**  
Arancio Vivace
- Golden Sage **NEW**  
Salvia Dorata
- Deep Azure Steel **NEW**  
Azzurro Met. Intenso
- Clear  
Trasparente
- Frosted White  
Bianco Satinato
- Glossy Smoke  
Fumo Lucido
- Pale Gold **NEW**  
Oro Chiaro
- Glossy Bronze  
Bronzo Lucido
- Mandarin Orange **NEW**  
Arancio Vivace
- Golden Sage **NEW**  
Salvia Dorata
- Deep Azure Steel **NEW**  
Azzurro Met. Intenso

Canopy, structure and cable  
Rosone, Struttura e cavo

- Canopy/Rosone
- Matte White - 9010  
Bianco Opaco - 9010
- Silicone/Silicone
- White Translucent  
Bianco translucido
- White cable  
Cavo Bianco
- Canopy/Rosone
- Matte Black - 9005  
Nero Opaco - 9005 **NEW**
- Silicone/Silicone
- Matte Black  
Nero Opaco **NEW**
- Black cable  
Cavo Nero

Code Codice	Code Codice	VAT excluded IVA esclusa Euro €
22123 0027	22123 0030	3.576,00
22123 1327	22123 1330	5.284,00
22123 4327	22123 4330	5.284,00
22123 4527	22123 4530	5.284,00
22123 4627	22123 4630	5.284,00
22123 5827	22123 5830	5.284,00
22123 7127	22123 7130	5.284,00
22123 8627	22123 8630	5.284,00
22113 0027	22113 0030	3.576,00
22113 1327	22113 1330	5.284,00
22113 4327	22113 4330	5.284,00
22113 4527	22113 4530	5.284,00
22113 4627	22113 4630	5.284,00
22113 5827	22113 5830	5.284,00
22113 7127	22113 7130	5.284,00
22113 8627	22113 8630	5.284,00

**Light source**  
Sorgente luminosa

**A**

LED  
2700 K  
14x 3 W  
6300 lm  
350 mA  
CRI 90  
MacAdam 3-Step

LED and driver included  
LED e driver inclusi

**Light source**  
Sorgente luminosa

**B**

LED  
3000 K  
14x 3 W  
6720 lm  
350 mA  
CRI 90  
MacAdam 3-Step

LED and driver included  
LED e driver inclusi

Net weight 11,50 kg / Peso netto 25,35 lbs | Pack Colli 29 | Energy class Classe energetica D

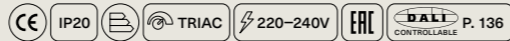

Random Cloud 14 Lights Ø28

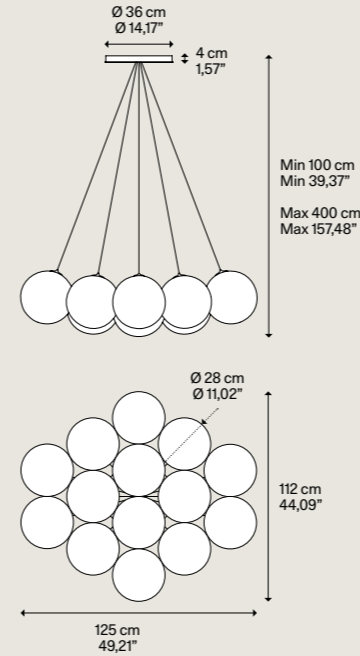

Blown glass diffuser  
Diffusore in vetro soffiato

- Clear  
Trasparente
- Frosted White  
Bianco Satinato
- Glossy Smoke  
Fumo Lucido
- Pale Gold **NEW**  
Oro Chiaro
- Glossy Bronze  
Bronzo Lucido
- Mandarin Orange **NEW**  
Arancio Vivace
- Golden Sage **NEW**  
Salvia Dorata
- Deep Azure Steel **NEW**  
Azzurro Met. Intenso
- Clear  
Trasparente
- Frosted White  
Bianco Satinato
- Glossy Smoke  
Fumo Lucido
- Pale Gold **NEW**  
Oro Chiaro
- Glossy Bronze  
Bronzo Lucido
- Mandarin Orange **NEW**  
Arancio Vivace
- Golden Sage **NEW**  
Salvia Dorata
- Deep Azure Steel **NEW**  
Azzurro Met. Intenso

Canopy, structure and cable  
Rosone, Struttura e cavo

- Canopy/Rosone
- Matte White - 9010  
Bianco Opaco - 9010
- Silicone/Silicone
- White Translucent  
Bianco translucido
- White cable  
Cavo Bianco
- Canopy/Rosone
- Matte Black - 9005  
Nero Opaco - 9005 **NEW**
- Silicone/Silicone
- Matte Black  
Nero Opaco **NEW**
- Black cable  
Cavo Nero

**Light source**  
Sorgente luminosa

**A**

LED  
2700 K  
14x 3 W  
6300 lm  
350 mA  
CRI 90  
MacAdam 3-Step

LED and driver included  
LED e driver inclusi

**Light source**  
Sorgente luminosa

**B**

LED  
3000 K  
14x 3 W  
6720 lm  
350 mA  
CRI 90  
MacAdam 3-Step

LED and driver included  
LED e driver inclusi

Net weight 15,70 kg / Peso netto 34,61 lbs | Pack Colli 29 | Energy class Classe energetica D



Random Cloud 19 Lights Ø23

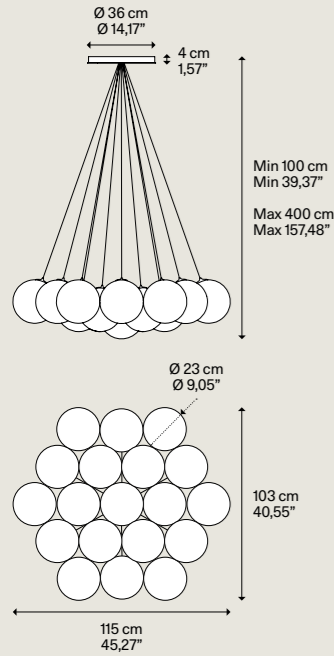

Blown glass diffuser Diffusore in vetro soffiato	Canopy, structure and cable Rosone, Struttura e cavo	Code Codice	A	Code Codice	B	Euro €
Clear Trasparente		22125 0027		22125 0030		4.751,00
Frosted White Bianco Satinato		22125 1327		22125 1330		7.069,00
Glossy Smoke Fumo Lucido		22125 4327		22125 4330		7.069,00
Pale Gold <b>NEW</b> Oro Chiaro	Canopy/Rosone	22125 4527		22125 4530		7.069,00
Glossy Bronze Bronzo Lucido	Matte White - 9010 Bianco Opaco - 9010	22125 4627		22125 4630		7.069,00
Mandarin Orange <b>NEW</b> Arancio Vivace	Silicone/Silicone	22125 5827		22125 5830		7.069,00
Golden Sage <b>NEW</b> Salvia Dorata	White Translucent Bianco translucido	22125 7127		22125 7130		7.069,00
Deep Azure Steel <b>NEW</b> Azzurro Met. Intenso	White cable Cavo Bianco	22125 8627		22125 8630		7.069,00
Clear Trasparente		22115 0027		22115 0030		4.751,00
Frosted White Bianco Satinato		22115 1327		22115 1330		7.069,00
Glossy Smoke Fumo Lucido		22115 4327		22115 4330		7.069,00
Pale Gold <b>NEW</b> Oro Chiaro	Canopy/Rosone	22115 4527		22115 4530		7.069,00
Glossy Bronze Bronzo Lucido	Matte Black - 9005 Nero Opaco - 9005 <b>NEW</b>	22115 4627		22115 4630		7.069,00
Mandarin Orange <b>NEW</b> Arancio Vivace	Silicone/Silicone	22115 5827		22115 5830		7.069,00
Golden Sage <b>NEW</b> Salvia Dorata	Matte Black Nero Opaco <b>NEW</b>	22115 7127		22115 7130		7.069,00
Deep Azure Steel <b>NEW</b> Azzurro Met. Intenso	Black cable Cavo Nero	22115 8627		22115 8630		7.069,00
<b>Light source</b> Sorgente luminosa	<b>Light source</b> Sorgente luminosa					
<b>A</b>	<b>B</b>					
LED	LED					
2700 K	3000 K					
19x3 W	19x3 W					
8550 lm	9120 lm					
350 mA	350 mA					
CRI 90	CRI 90					
MacAdam 3-Step	MacAdam 3-Step					
LED and driver included LED e driver inclusi	LED and driver included LED e driver inclusi					

Net weight 14,50 kg / Peso netto 31,96 lbs | Pack Colli 39 | Energy class Classe energetica D

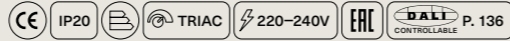

Random Cloud 19 Lights Ø28

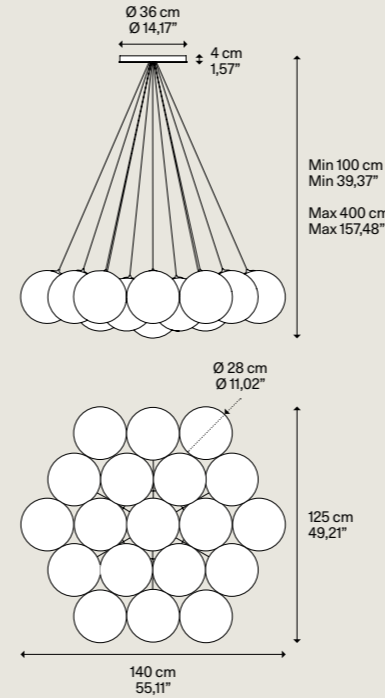

Blown glass diffuser Diffusore in vetro soffiato	Canopy, structure and cable Rosone, Struttura e cavo	Code Codice	A	Code Codice	B	Euro €
Clear Trasparente		22126 0027		22126 0030		5.530,00
Frosted White Bianco Satinato		22126 1327		22126 1330		7.848,00
Glossy Smoke Fumo Lucido		22126 4327		22126 4330		7.848,00
Pale Gold <b>NEW</b> Oro Chiaro	Canopy/Rosone	22126 4527		22126 4530		7.848,00
Glossy Bronze Bronzo Lucido	Matte White - 9010 Bianco Opaco - 9010	22126 4627		22126 4630		7.848,00
Mandarin Orange <b>NEW</b> Arancio Vivace	Silicone/Silicone	22126 5827		22126 5830		7.848,00
Golden Sage <b>NEW</b> Salvia Dorata	White Translucent Bianco translucido	22126 7127		22126 7130		7.848,00
Deep Azure Steel <b>NEW</b> Azzurro Met. Intenso	White cable Cavo Bianco	22126 8627		22126 8630		7.848,00
Clear Trasparente		22116 0027		22116 0030		5.530,00
Frosted White Bianco Satinato		22116 1327		22116 1330		7.848,00
Glossy Smoke Fumo Lucido		22116 4327		22116 4330		7.848,00
Pale Gold <b>NEW</b> Oro Chiaro	Canopy/Rosone	22116 4527		22116 4530		7.848,00
Glossy Bronze Bronzo Lucido	Matte Black - 9005 Nero Opaco - 9005 <b>NEW</b>	22116 4627		22116 4630		7.848,00
Mandarin Orange <b>NEW</b> Arancio Vivace	Silicone/Silicone	22116 5827		22116 5830		7.848,00
Golden Sage <b>NEW</b> Salvia Dorata	Matte Black Nero Opaco <b>NEW</b>	22116 7127		22116 7130		7.848,00
Deep Azure Steel <b>NEW</b> Azzurro Met. Intenso	Black cable Cavo Nero	22116 8627		22116 8630		7.848,00
<b>Light source</b> Sorgente luminosa	<b>Light source</b> Sorgente luminosa					
<b>A</b>	<b>B</b>					
LED	LED					
2700 K	3000 K					
19x3 W	19x3 W					
8550 lm	9120 lm					
350 mA	350 mA					
CRI 90	CRI 90					
MacAdam 3-Step	MacAdam 3-Step					
LED and driver included LED e driver inclusi	LED and driver included LED e driver inclusi					

Net weight 20,20 kg / Peso netto 44,53 lbs | Pack Colli 39 | Energy class Classe energetica D

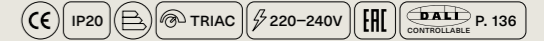

Random Cloud 23 Lights Ø23

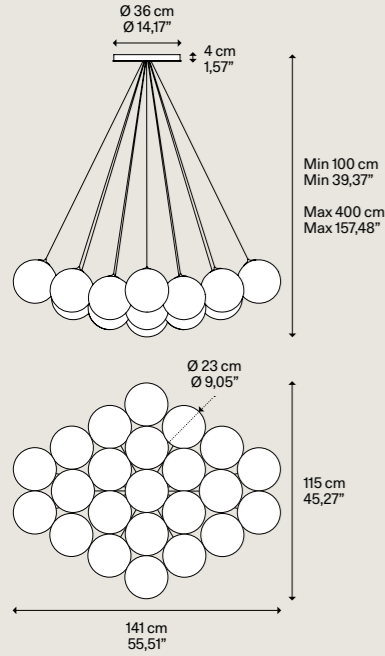

Blown glass diffuser  
Diffusore in vetro soffiato

- Clear  
Trasparente
- Frosted White  
Bianco Satinato
- Glossy Smoke  
Fumo Lucido
- Pale Gold **NEW**  
Oro Chiaro
- Glossy Bronze  
Bronzo Lucido
- Mandarin Orange **NEW**  
Arancio Vivace
- Golden Sage **NEW**  
Salvia Dorata
- Deep Azure Steel **NEW**  
Azzurro Met. Intenso

- Clear  
Trasparente
- Frosted White  
Bianco Satinato
- Glossy Smoke  
Fumo Lucido
- Pale Gold **NEW**  
Oro Chiaro
- Glossy Bronze  
Bronzo Lucido
- Mandarin Orange **NEW**  
Arancio Vivace
- Golden Sage **NEW**  
Salvia Dorata
- Deep Azure Steel **NEW**  
Azzurro Met. Intenso

Canopy, structure and cable  
Rosone, Struttura e cavo

- Canopy/Rosone
- Matte White - 9010  
Bianco Opaco - 9010
- Silicone/Silicone
- White Translucent  
Bianco traslucido
  - White cable  
Cavo Bianco

- Canopy/Rosone
- Matte Black - 9005  
Nero Opaco - 9005 **NEW**
- Silicone/Silicone
- Matte Black  
Nero Opaco **NEW**
  - Black cable  
Cavo Nero

Light source  
Sorgente luminosa

LED  
2700 K  
23x 3 W  
10350 lm  
350 mA  
CRI 90  
MacAdam 3-Step  
LED and driver included  
LED e driver inclusi

Light source  
Sorgente luminosa

LED  
3000 K  
23x 3 W  
11040 lm  
350 mA  
CRI 90  
MacAdam 3-Step  
LED and driver included  
LED e driver inclusi

Net weight 16,90 kg / Peso netto 37,25 lbs | Pack Colli 47 | Energy class Classe energetica D

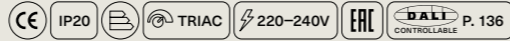

Code Codice	Code Codice	Euro €
22127 0027	22127 0030	5.691,00
22127 1327	22127 1330	8.497,00
22127 4327	22127 4330	8.497,00
22127 4527	22127 4530	8.497,00
22127 4627	22127 4630	8.497,00
22127 5827	22127 5830	8.497,00
22127 7127	22127 7130	8.497,00
22127 8627	22127 8630	8.497,00
22117 0027	22117 0030	5.691,00
22117 1327	22117 1330	8.497,00
22117 4327	22117 4330	8.497,00
22117 4527	22117 4530	8.497,00
22117 4627	22117 4630	8.497,00
22117 5827	22117 5830	8.497,00
22117 7127	22117 7130	8.497,00
22117 8627	22117 8630	8.497,00

Random Cloud 23 Lights Ø28

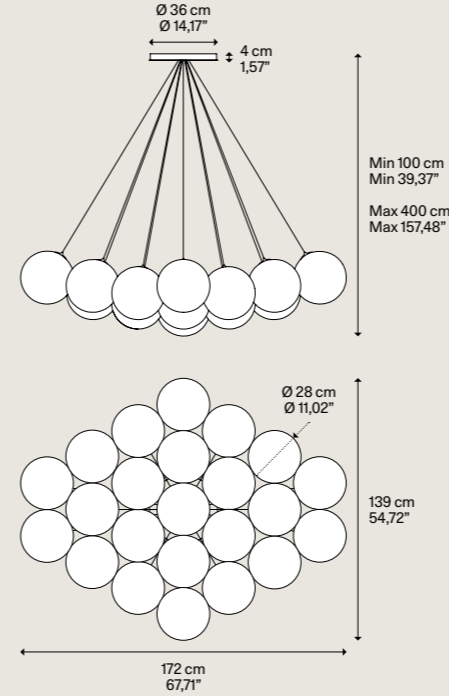

Blown glass diffuser  
Diffusore in vetro soffiato

- Clear  
Trasparente
- Frosted White  
Bianco Satinato
- Glossy Smoke  
Fumo Lucido
- Pale Gold **NEW**  
Oro Chiaro
- Glossy Bronze  
Bronzo Lucido
- Mandarin Orange **NEW**  
Arancio Vivace
- Golden Sage **NEW**  
Salvia Dorata
- Deep Azure Steel **NEW**  
Azzurro Met. Intenso

- Clear  
Trasparente
- Frosted White  
Bianco Satinato
- Glossy Smoke  
Fumo Lucido
- Pale Gold **NEW**  
Oro Chiaro
- Glossy Bronze  
Bronzo Lucido
- Mandarin Orange **NEW**  
Arancio Vivace
- Golden Sage **NEW**  
Salvia Dorata
- Deep Azure Steel **NEW**  
Azzurro Met. Intenso

Canopy, structure and cable  
Rosone, Struttura e cavo

- Canopy/Rosone
- Matte White - 9010  
Bianco Opaco - 9010
- Silicone/Silicone
- White Translucent  
Bianco traslucido
  - White cable  
Cavo Bianco

- Canopy/Rosone
- Matte Black - 9005  
Nero Opaco - 9005 **NEW**
- Silicone/Silicone
- Matte Black  
Nero Opaco **NEW**
  - Black cable  
Cavo Nero

Light source  
Sorgente luminosa

LED  
2700 K  
23x 3 W  
10350 lm  
350 mA  
CRI 90  
MacAdam 3-Step  
LED and driver included  
LED e driver inclusi

Light source  
Sorgente luminosa

LED  
3000 K  
23x 3 W  
11040 lm  
350 mA  
CRI 90  
MacAdam 3-Step  
LED and driver included  
LED e driver inclusi

Net weight 23,80 kg / Peso netto 52,47 lbs | Pack Colli 47 | Energy class Classe energetica D

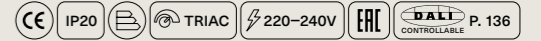

Code Codice	Code Codice	Euro €
22128 0027	22128 0030	6.634,00
22128 1327	22128 1330	9.440,00
22128 4327	22128 4330	9.440,00
22128 4527	22128 4530	9.440,00
22128 4627	22128 4630	9.440,00
22128 5827	22128 5830	9.440,00
22128 7127	22128 7130	9.440,00
22128 8627	22128 8630	9.440,00
22118 0027	22118 0030	6.634,00
22118 1327	22118 1330	9.440,00
22118 4327	22118 4330	9.440,00
22118 4527	22118 4530	9.440,00
22118 4627	22118 4630	9.440,00
22118 5827	22118 5830	9.440,00
22118 7127	22118 7130	9.440,00
22118 8627	22118 8630	9.440,00

# Random Stick short

Description Descrizione	Dimensions Dimensioni	
Metal structure Montatura in metallo	100 cm 39,37"	①
Blown glass sphere Sfera in vetro soffiato	Ø 10 cm Ø 3,93"	②
Blown glass sphere Sfera in vetro soffiato	Ø 12 cm Ø 4,72"	③
Blown glass sphere Sfera in vetro soffiato	Ø 14 cm Ø 5,51"	④
Blown glass sphere Sfera in vetro soffiato	Ø 10 cm Ø 3,93"	⑤

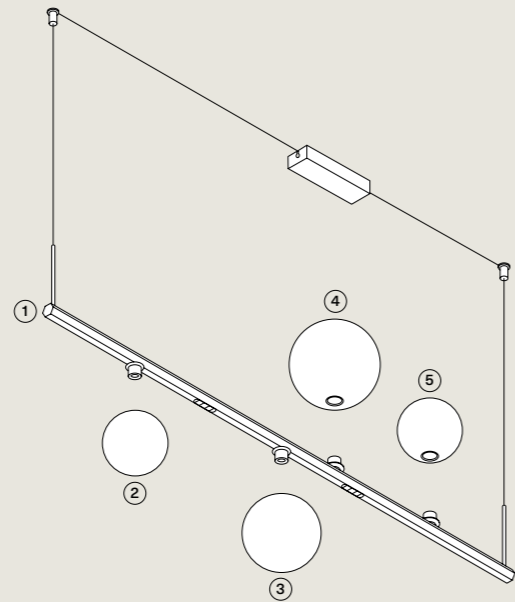

Net weight Peso netto	1,83 kg 4,03 lbs	Pack Colli	5	Energy class Classe energetica	D
--------------------------	---------------------	---------------	---	-----------------------------------	---

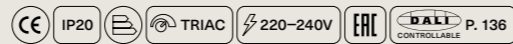

For the product coding, see table ► P. 028  
Per la codifica del prodotto, consultare la tabella ► P. 028

## Random Stick short

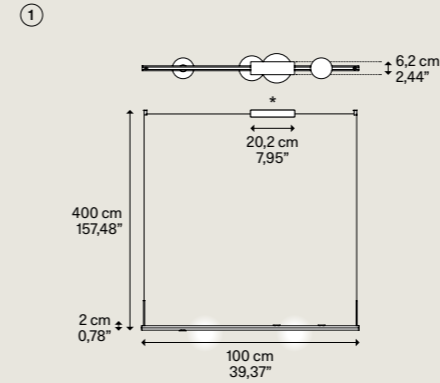

\* Adjustable canopy position  
\* Posizione del rosone regolabile

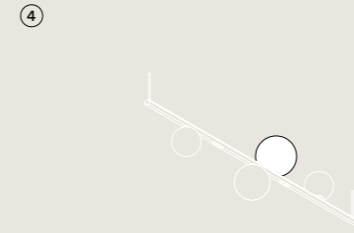
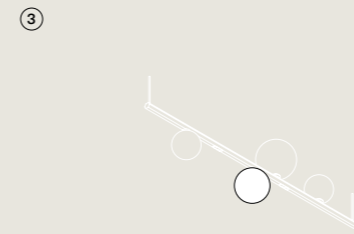
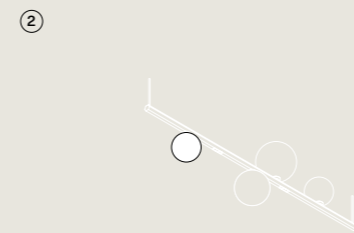

Metal structure Montatura in metallo		Code Codice	A Code Codice	B Code Codice	Euro €
I	Black Chrome Cromo Nero	23420M 2227	23420M 2230		740,00
II	Glossy Gold Oro Lucido	23420M 5027	23420M 5030		890,00



Light source Sorgente luminosa	
LED	K
2700	
2x 3 W + 4x 1 W	
1500	lm
Diffused light	600 lm
Direct light	900 lm
350	mA
CRI 90	
MacAdam 3-Step	

LED and driver included  
LED e driver inclusi

Light source Sorgente luminosa	
LED	K
3000	
2x 3 W + 4x 1 W	
1600	lm
Diffused light	640 lm
Direct light	960 lm
350	mA
CRI 90	
MacAdam 3-Step	

LED and driver included  
LED e driver inclusi

Description Descrizione	Blown glass diffuser Diffusore in vetro soffiato	Code Codice	Euro €
Sphere Ø 10 cm/3,93"	III Clear Trasparente	17110V 00	16,00
Sfera Ø 10 cm/3,93"	IV Frosted White Bianco Satinato	17110V 13	39,00
	V Glossy Smoke Fumo Lucido	17110V 43	39,00
	VI Pale Gold <i>NEW</i> Oro Chiaro <i>NEW</i>	17110V 45	39,00
	VII Glossy Bronze Bronzo Lucido	17110V 46	39,00
	VIII Mandarin Orange <i>NEW</i> Arancio Vivace <i>NEW</i>	17110V 58	39,00
	IX Golden Sage <i>NEW</i> Salvia Dorata <i>NEW</i>	17110V 71	39,00
	X Deep Azure Steel <i>NEW</i> Azzurro Met. Intenso <i>NEW</i>	17110V 86	39,00



Description Descrizione	Blown glass diffuser Diffusore in vetro soffiato	Code Codice	Euro €
Sphere Ø 12 cm/4,72"	III Clear Trasparente	17111V 00	39,00
Sfera Ø 12 cm/4,72"	IV Frosted White Bianco Satinato	17111V 13	64,00
	V Glossy Smoke Fumo Lucido	17111V 43	64,00
	VI Pale Gold <i>NEW</i> Oro Chiaro <i>NEW</i>	17111V 45	64,00
	VII Glossy Bronze Bronzo Lucido	17111V 46	64,00
	VIII Mandarin Orange <i>NEW</i> Arancio Vivace <i>NEW</i>	17111V 58	64,00
	IX Golden Sage <i>NEW</i> Salvia Dorata <i>NEW</i>	17111V 71	64,00
	X Deep Azure Steel <i>NEW</i> Azzurro Met. Intenso <i>NEW</i>	17111V 86	64,00



Description Descrizione	Blown glass diffuser Diffusore in vetro soffiato	Code Codice	Euro €
Sphere Ø 14 cm/5,51"	III Clear Trasparente	17112V 00	44,00
Sfera Ø 14 cm/5,51"	IV Frosted White Bianco Satinato	17112V 13	75,00
	V Glossy Smoke Fumo Lucido	17112V 43	75,00
	VI Pale Gold <i>NEW</i> Oro Chiaro <i>NEW</i>	17112V 45	75,00
	VII Glossy Bronze Bronzo Lucido	17112V 46	75,00
	VIII Mandarin Orange <i>NEW</i> Arancio Vivace <i>NEW</i>	17112V 58	75,00
	IX Golden Sage <i>NEW</i> Salvia Dorata <i>NEW</i>	17112V 71	75,00
	X Deep Azure Steel <i>NEW</i> Azzurro Met. Intenso <i>NEW</i>	17112V 86	75,00



Description Descrizione	Blown glass diffuser Diffusore in vetro soffiato	Code Codice	Euro €
Sphere Ø 10 cm/3,93"	III Clear Trasparente	17110V 00	16,00
Sfera Ø 10 cm/3,93"	IV Frosted White Bianco Satinato	17110V 13	39,00
	V Glossy Smoke Fumo Lucido	17110V 43	39,00
	VI Pale Gold <i>NEW</i> Oro Chiaro <i>NEW</i>	17110V 45	39,00
	VII Glossy Bronze Bronzo Lucido	17110V 46	39,00
	VIII Mandarin Orange <i>NEW</i> Arancio Vivace <i>NEW</i>	17110V 58	39,00
	IX Golden Sage <i>NEW</i> Salvia Dorata <i>NEW</i>	17110V 71	39,00
	X Deep Azure Steel <i>NEW</i> Azzurro Met. Intenso <i>NEW</i>	17110V 86	39,00



# Random Stick medium

Description Descrizione	Dimensions Dimensioni	
Metal structure Montatura in metallo	120 cm 47,24"	①
Blown glass sphere Sfera in vetro soffiato	Ø 10 cm Ø 3,93"	②
Blown glass sphere Sfera in vetro soffiato	Ø 14 cm Ø 5,51"	③
Blown glass sphere Sfera in vetro soffiato	Ø 18 cm Ø 7,08"	④
Blown glass sphere Sfera in vetro soffiato	Ø 10 cm Ø 3,93"	⑤

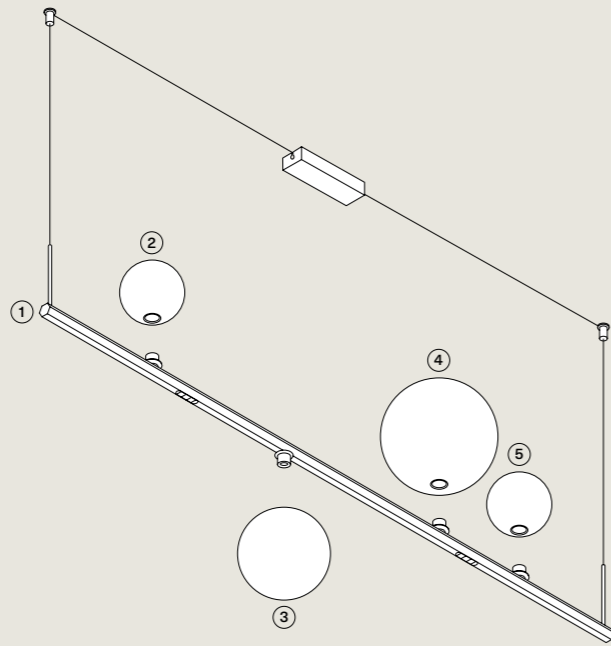

Net weight Peso netto	1,95 kg 4,29 lbs	Pack Colli	5	Energy class Classe energetica	D
--------------------------	---------------------	---------------	---	-----------------------------------	---

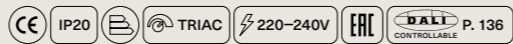

For the product coding, see table ► P. 029  
Per la codifica del prodotto, consultare la tabella ► P. 029

## Random Stick medium

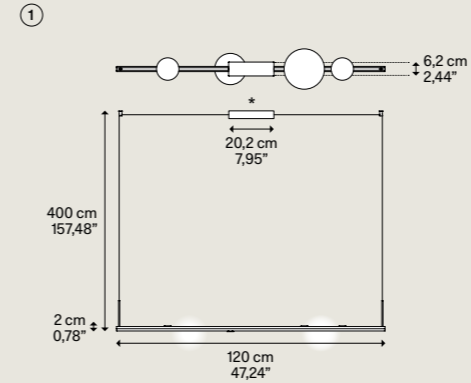

\* Adjustable canopy position  
\* Posizione del rosone regolabile

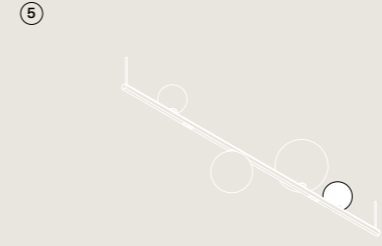
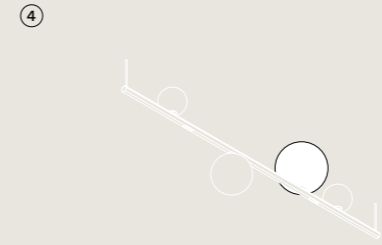
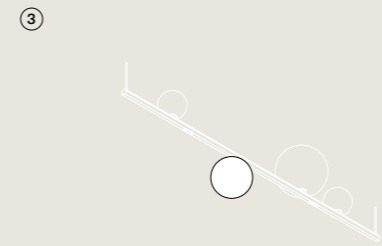

Metal structure Montatura in metallo		Code Codice	A	Code Codice	B	Euro €	VAT excluded IVA esclusa
I Black Chrome Cromo Nero		23424M 2227		23424M 2230		815,00	
II Glossy Gold Oro Lucido		23424M 5027		23424M 5030		980,00	



Light source Sorgente luminosa	A	Light source Sorgente luminosa	B
LED 2700 2x 3 W + 4x 1 W 1500 Diffused light > 600 lm Direct light > 900 lm 350 CRI 90 MacAdam 3-Step	K	LED 3000 2x 3 W + 4x 1 W 1600 Diffused light > 640 lm Direct light > 960 lm 350 CRI 90 MacAdam 3-Step	K

LED and driver included  
LED e driver inclusi

VAT excluded  
IVA esclusa

Description Descrizione	Blown glass diffuser Diffusore in vetro soffiato	Code Codice	Euro €
Sphere Ø 10 cm/3,93"	III Clear Trasparente	17110V 00	16,00
Sfera Ø 10 cm/3,93"	IV Frosted White Bianco Satinato	17110V 13	39,00
	V Glossy Smoke Fumo Lucido	17110V 43	39,00
	VI Pale Gold <i>NEW</i> Oro Chiaro <i>NEW</i>	17110V 45	39,00
	VII Glossy Bronze Bronzo Lucido	17110V 46	39,00
	VIII Mandarin Orange <i>NEW</i> Arancio Vivace <i>NEW</i>	17110V 58	39,00
	IX Golden Sage <i>NEW</i> Salvia Dorata <i>NEW</i>	17110V 71	39,00
	X Deep Azure Steel <i>NEW</i> Azzurro Met. Intenso <i>NEW</i>	17110V 86	39,00



Description Descrizione	Blown glass diffuser Diffusore in vetro soffiato	Code Codice	Euro €
Sphere Ø 14 cm/5,51"	III Clear Trasparente	17112V 00	44,00
Sfera Ø 14 cm/5,51"	IV Frosted White Bianco Satinato	17112V 13	75,00
	V Glossy Smoke Fumo Lucido	17112V 43	75,00
	VI Pale Gold <i>NEW</i> Oro Chiaro <i>NEW</i>	17112V 45	75,00
	VII Glossy Bronze Bronzo Lucido	17112V 46	75,00
	VIII Mandarin Orange <i>NEW</i> Arancio Vivace <i>NEW</i>	17112V 58	75,00
	IX Golden Sage <i>NEW</i> Salvia Dorata <i>NEW</i>	17112V 71	75,00
	X Deep Azure Steel <i>NEW</i> Azzurro Met. Intenso <i>NEW</i>	17112V 86	75,00



Description Descrizione	Blown glass diffuser Diffusore in vetro soffiato	Code Codice	Euro €
Sphere Ø 18 cm/7,08"	III Clear Trasparente	17113V 00	59,00
Sfera Ø 18 cm/7,08"	IV Frosted White Bianco Satinato	17113V 13	90,00
	V Glossy Smoke Fumo Lucido	17113V 43	90,00
	VI Pale Gold <i>NEW</i> Oro Chiaro <i>NEW</i>	17113V 45	90,00
	VII Glossy Bronze Bronzo Lucido	17113V 46	90,00
	VIII Mandarin Orange <i>NEW</i> Arancio Vivace <i>NEW</i>	17113V 58	90,00
	IX Golden Sage <i>NEW</i> Salvia Dorata <i>NEW</i>	17113V 71	90,00
	X Deep Azure Steel <i>NEW</i> Azzurro Met. Intenso <i>NEW</i>	17113V 86	90,00



Description Descrizione	Blown glass diffuser Diffusore in vetro soffiato	Code Codice	Euro €
Sphere Ø 10 cm/3,93"	III Clear Trasparente	17110V 00	16,00
Sfera Ø 10 cm/3,93"	IV Frosted White Bianco Satinato	17110V 13	39,00
	V Glossy Smoke Fumo Lucido	17110V 43	39,00
	VI Pale Gold <i>NEW</i> Oro Chiaro <i>NEW</i>	17110V 45	39,00
	VII Glossy Bronze Bronzo Lucido	17110V 46	39,00
	VIII Mandarin Orange <i>NEW</i> Arancio Vivace <i>NEW</i>	17110V 58	39,00
	IX Golden Sage <i>NEW</i> Salvia Dorata <i>NEW</i>	17110V 71	39,00
	X Deep Azure Steel <i>NEW</i> Azzurro Met. Intenso <i>NEW</i>	17110V 86	39,00



# Random Stick long

Description Descrizione	Dimensions Dimensioni	
Metal structure Montatura in metallo	150 cm 59,05"	①
Blown glass sphere Sfera in vetro soffiato	Ø 14 cm Ø 5,51"	②
Blown glass sphere Sfera in vetro soffiato	Ø 10 cm Ø 3,93"	③
Blown glass sphere Sfera in vetro soffiato	Ø 12 cm Ø 4,72"	④
Blown glass sphere Sfera in vetro soffiato	Ø 18 cm Ø 7,08"	⑤
Blown glass sphere Sfera in vetro soffiato	Ø 10 cm Ø 3,93"	⑥
Blown glass sphere Sfera in vetro soffiato	Ø 18 cm Ø 7,08"	⑦

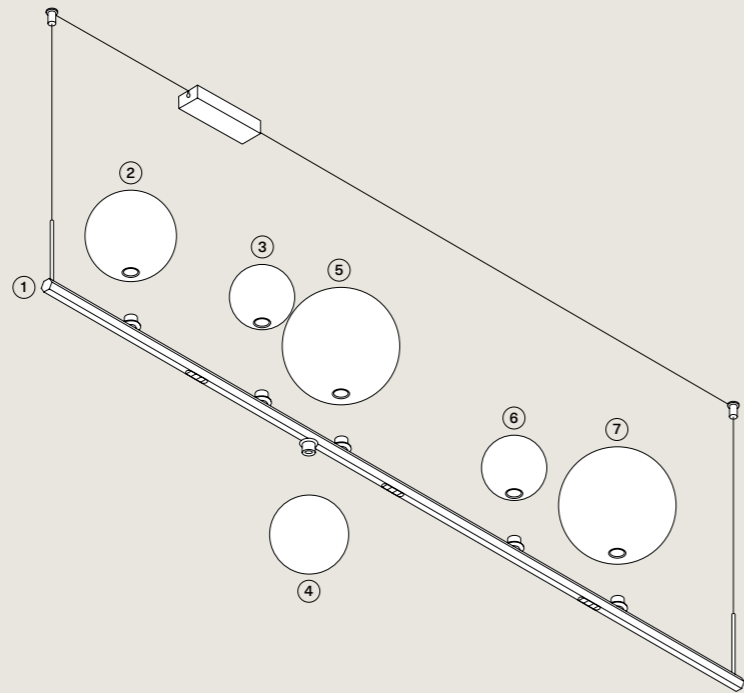

Net weight Peso netto	2,84 kg 6,26 lbs	Pack Colli	7	Energy class Classe energetica	D
--------------------------	---------------------	---------------	---	-----------------------------------	---

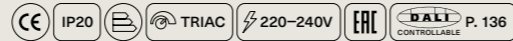

For the product coding, see table ► P. 030  
Per la codifica del prodotto, consultare la tabella ► P. 030

## Random Stick long

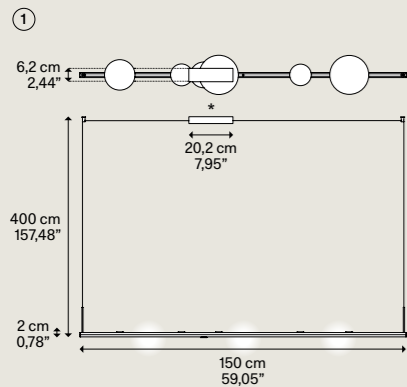

Metal structure Montatura in metallo		Code Codice	Code Codice	Euro €
I Black Chrome Cromo Nero		23421M 2227	23421M 2230	950,00
II Glossy Gold Oro Lucido		23421M 5027	23421M 5030	1.150,00



Light source Sorgente luminosa	
LED 2700 3x 3 W + 6x 1 W 2250 Diffused light ≡ 900 lm Direct light ≡ 1350 lm 350 CRI 90 MacAdam 3-Step	K

LED and driver included  
LED e driver inclusi

Light source Sorgente luminosa	
LED 3000 3x 3 W + 6x 1 W 2400 Diffused light ≡ 980 lm Direct light ≡ 1720 lm 350 CRI 90 MacAdam 3-Step	K

LED and driver included  
LED e driver inclusi

\* Adjustable canopy position  
\* Posizione del rosone regolabile

VAT excluded  
IVA esclusa

## Random Stick long

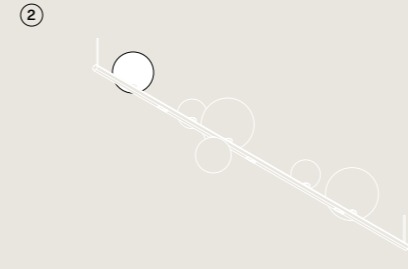

Description Descrizione	Blown glass diffuser Diffusore in vetro soffiato	Code Codice	Euro €
Sphere Ø 14 cm/5,51"	III Clear Trasparente	17112V 00	44,00
Sfera Ø 14 cm/5,51"	IV Frosted White Bianco Satinato	17112V 13	75,00
	V Glossy Smoke Fumo Lucido	17112V 43	75,00
	VI Pale Gold <i>NEW</i> Oro Chiaro <i>NEW</i>	17112V 45	75,00
	VII Glossy Bronze Bronzo Lucido	17112V 46	75,00
	VIII Mandarin Orange <i>NEW</i> Arancio Vivace <i>NEW</i>	17112V 58	75,00
	IX Golden Sage <i>NEW</i> Salvia Dorata <i>NEW</i>	17112V 71	75,00
	X Deep Azure Steel <i>NEW</i> Azzurro Met. Intenso <i>NEW</i>	17112V 86	75,00



Description Descrizione	Blown glass diffuser Diffusore in vetro soffiato	Code Codice	Euro €
Sphere Ø 10 cm/3,93"	III Clear Trasparente	17110V 00	16,00
Sfera Ø 10 cm/3,93"	IV Frosted White Bianco Satinato	17110V 13	39,00
	V Glossy Smoke Fumo Lucido	17110V 43	39,00
	VI Pale Gold <i>NEW</i> Oro Chiaro <i>NEW</i>	17110V 45	39,00
	VII Glossy Bronze Bronzo Lucido	17110V 46	39,00
	VIII Mandarin Orange <i>NEW</i> Arancio Vivace <i>NEW</i>	17110V 58	39,00
	IX Golden Sage <i>NEW</i> Salvia Dorata <i>NEW</i>	17110V 71	39,00
	X Deep Azure Steel <i>NEW</i> Azzurro Met. Intenso <i>NEW</i>	17110V 86	39,00



Description Descrizione	Blown glass diffuser Diffusore in vetro soffiato	Code Codice	Euro €
Sphere Ø 12 cm/4,72"	III Clear Trasparente	17111V 00	39,00
Sfera Ø 12 cm/4,72"	IV Frosted White Bianco Satinato	17111V 13	64,00
	V Glossy Smoke Fumo Lucido	17111V 43	64,00
	VI Pale Gold <i>NEW</i> Oro Chiaro <i>NEW</i>	17111V 45	64,00
	VII Glossy Bronze Bronzo Lucido	17111V 46	64,00
	VIII Mandarin Orange <i>NEW</i> Arancio Vivace <i>NEW</i>	17111V 58	64,00
	IX Golden Sage <i>NEW</i> Salvia Dorata <i>NEW</i>	17111V 71	64,00
	X Deep Azure Steel <i>NEW</i> Azzurro Met. Intenso <i>NEW</i>	17111V 86	64,00



Description Descrizione	Blown glass diffuser Diffusore in vetro soffiato	Code Codice	Euro €
Sphere Ø 18 cm/7,08"	III Clear Trasparente	17113V 00	59,00
Sfera Ø 18 cm/7,08"	IV Frosted White Bianco Satinato	17113V 13	90,00
	V Glossy Smoke Fumo Lucido	17113V 43	90,00
	VI Pale Gold <i>NEW</i> Oro Chiaro <i>NEW</i>	17113V 45	90,00
	VII Glossy Bronze Bronzo Lucido	17113V 46	90,00
	VIII Mandarin Orange <i>NEW</i> Arancio Vivace <i>NEW</i>	17113V 58	90,00
	IX Golden Sage <i>NEW</i> Salvia Dorata <i>NEW</i>	17113V 71	90,00
	X Deep Azure Steel <i>NEW</i> Azzurro Met. Intenso <i>NEW</i>	17113V 86	90,00

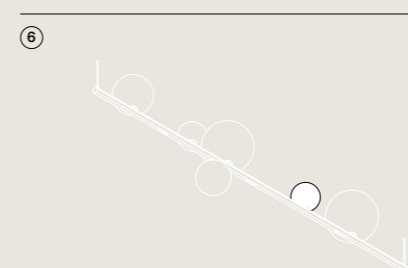

Description Descrizione	Blown glass diffuser Diffusore in vetro soffiato	Code Codice	Euro €
Sphere Ø 10 cm/3,93"	III Clear Trasparente	17110V 00	16,00
Sfera Ø 10 cm/3,93"	IV Frosted White Bianco Satinato	17110V 13	39,00
	V Glossy Smoke Fumo Lucido	17110V 43	39,00
	VI Pale Gold <i>NEW</i> Oro Chiaro <i>NEW</i>	17110V 45	39,00
	VII Glossy Bronze Bronzo Lucido	17110V 46	39,00
	VIII Mandarin Orange <i>NEW</i> Arancio Vivace <i>NEW</i>	17110V 58	39,00
	IX Golden Sage <i>NEW</i> Salvia Dorata <i>NEW</i>	17110V 71	39,00
	X Deep Azure Steel <i>NEW</i> Azzurro Met. Intenso <i>NEW</i>	17110V 86	39,00

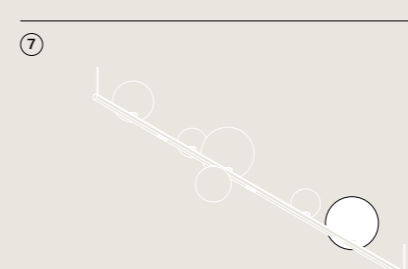

Description Descrizione	Blown glass diffuser Diffusore in vetro soffiato	Code Codice	Euro €
Sphere Ø 18 cm/7,08"	III Clear Trasparente	17113V 00	59,00
Sfera Ø 18 cm/7,08"	IV Frosted White Bianco Satinato	17113V 13	90,00
	V Glossy Smoke Fumo Lucido	17113V 43	90,00
	VI Pale Gold <i>NEW</i> Oro Chiaro <i>NEW</i>	17113V 45	90,00
	VII Glossy Bronze Bronzo Lucido	17113V 46	90,00
	VIII Mandarin Orange <i>NEW</i> Arancio Vivace <i>NEW</i>	17113V 58	90,00
	IX Golden Sage <i>NEW</i> Salvia Dorata <i>NEW</i>	17113V 71	90,00
	X Deep Azure Steel <i>NEW</i> Azzurro Met. Intenso <i>NEW</i>	17113V 86	90,00

# Random Stick XL

Description Descrizione	Dimensions Dimensioni	
Metal structure Montatura in metallo	180 cm 70,86"	①
Blown glass sphere Sfera in vetro soffiato	Ø 18 cm Ø 7,08"	②
Blown glass sphere Sfera in vetro soffiato	Ø 10 cm Ø 3,93"	③
Blown glass sphere Sfera in vetro soffiato	Ø 14 cm Ø 5,51"	④
Blown glass sphere Sfera in vetro soffiato	Ø 10 cm Ø 3,93"	⑤
Blown glass sphere Sfera in vetro soffiato	Ø 18 cm Ø 7,08"	⑥
Blown glass sphere Sfera in vetro soffiato	Ø 12 cm Ø 4,72"	⑦

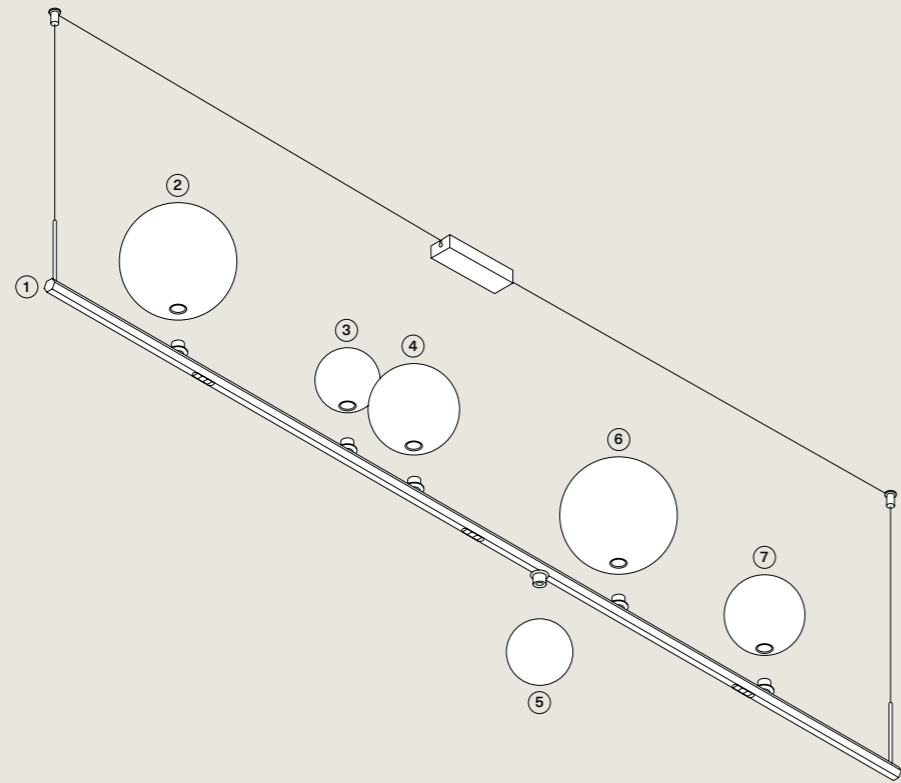

Net weight Peso netto	2,97 kg 6,54 lbs	Pack Colli	7	Energy class Classe energetica	D
--------------------------	---------------------	---------------	---	-----------------------------------	---

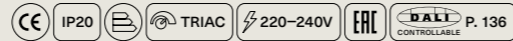

For the product coding, see table ► P. 031  
Per la codifica del prodotto, consultare la tabella ► P. 031

## Random Stick XL

VAT excluded  
IVA esclusa

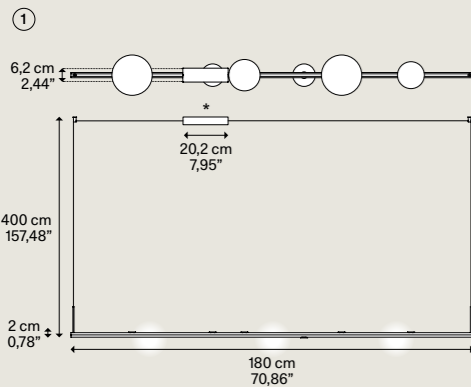

Metal structure Montatura in metallo		Code Codice	Code Codice	Euro €
I Black Chrome Cromo Nero		23425M 2227	23425M 2230	1.045,00
II Glossy Gold Oro Lucido		23425M 5027	23425M 5030	1.265,00



Light source Sorgente luminosa		Code Codice	Euro €
LED 2700 K 3x 3 W + 6x 1 W 2250 lm Diffused light √ 900 lm Direct light √ 1350 lm 350 mA CRI 90 MacAdam 3-Step	A	23425M 2227	1.045,00

Light source Sorgente luminosa		Code Codice	Euro €
LED 3000 K 3x 3 W + 6x 1 W 2400 lm Diffused light √ 980 lm Direct light √ 1720 lm 350 mA CRI 90 MacAdam 3-Step	B	23425M 2230	1.045,00

LED and driver included  
LED e driver inclusi

LED and driver included  
LED e driver inclusi

\* Adjustable canopy position  
\* Posizione del rosone regolabile

## Random Stick XL

VAT excluded  
IVA esclusa

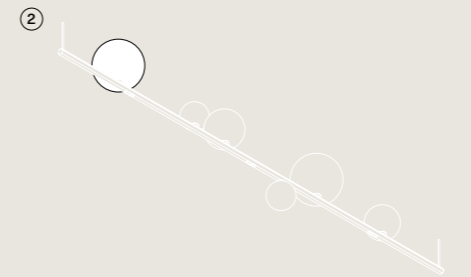

Description Descrizione	Blown glass diffuser Diffusore in vetro soffiato	Code Codice	Euro €
Sphere Ø 18 cm/7,08"	III Clear Trasparente	17113V 00	59,00
Sfera Ø 18 cm/7,08"	IV Frosted White Bianco Satinato	17113V 13	90,00
	V Glossy Smoke Fumo Lucido	17113V 43	90,00
	VI Pale Gold <b>NEW</b> Oro Chiaro <b>NEW</b>	17113V 45	90,00
	VII Glossy Bronze Bronzo Lucido	17113V 46	90,00
	VIII Mandarin Orange <b>NEW</b> Arancio Vivace <b>NEW</b>	17113V 58	90,00
	IX Golden Sage <b>NEW</b> Salvia Dorata <b>NEW</b>	17113V 71	90,00
	X Deep Azure Steel <b>NEW</b> Azzurro Met. Intenso <b>NEW</b>	17113V 86	90,00



Description Descrizione	Blown glass diffuser Diffusore in vetro soffiato	Code Codice	Euro €
Sphere Ø 10 cm/3,93"	III Clear Trasparente	17110V 00	16,00
Sfera Ø 10 cm/3,93"	IV Frosted White Bianco Satinato	17110V 13	39,00
	V Glossy Smoke Fumo Lucido	17110V 43	39,00
	VI Pale Gold <b>NEW</b> Oro Chiaro <b>NEW</b>	17110V 45	39,00
	VII Glossy Bronze Bronzo Lucido	17110V 46	39,00
	VIII Mandarin Orange <b>NEW</b> Arancio Vivace <b>NEW</b>	17110V 58	39,00
	IX Golden Sage <b>NEW</b> Salvia Dorata <b>NEW</b>	17110V 71	39,00
	X Deep Azure Steel <b>NEW</b> Azzurro Met. Intenso <b>NEW</b>	17110V 86	39,00



Description Descrizione	Blown glass diffuser Diffusore in vetro soffiato	Code Codice	Euro €
Sphere Ø 14 cm/5,51"	III Clear Trasparente	17112V 00	44,00
Sfera Ø 14 cm/5,51"	IV Frosted White Bianco Satinato	17112V 13	75,00
	V Glossy Smoke Fumo Lucido	17112V 43	75,00
	VI Pale Gold <b>NEW</b> Oro Chiaro <b>NEW</b>	17112V 45	75,00
	VII Glossy Bronze Bronzo Lucido	17112V 46	75,00
	VIII Mandarin Orange <b>NEW</b> Arancio Vivace <b>NEW</b>	17112V 58	75,00
	IX Golden Sage <b>NEW</b> Salvia Dorata <b>NEW</b>	17112V 71	75,00
	X Deep Azure Steel <b>NEW</b> Azzurro Met. Intenso <b>NEW</b>	17112V 86	75,00



Description Descrizione	Blown glass diffuser Diffusore in vetro soffiato	Code Codice	Euro €
Sphere Ø 10 cm/3,93"	III Clear Trasparente	17110V 00	16,00
Sfera Ø 10 cm/3,93"	IV Frosted White Bianco Satinato	17110V 13	39,00
	V Glossy Smoke Fumo Lucido	17110V 43	39,00
	VI Pale Gold <b>NEW</b> Oro Chiaro <b>NEW</b>	17110V 45	39,00
	VII Glossy Bronze Bronzo Lucido	17110V 46	39,00
	VIII Mandarin Orange <b>NEW</b> Arancio Vivace <b>NEW</b>	17110V 58	39,00
	IX Golden Sage <b>NEW</b> Salvia Dorata <b>NEW</b>	17110V 71	39,00
	X Deep Azure Steel <b>NEW</b> Azzurro Met. Intenso <b>NEW</b>	17110V 86	39,00

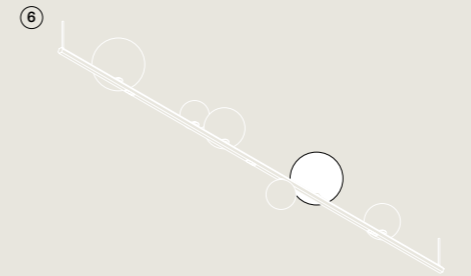

Description Descrizione	Blown glass diffuser Diffusore in vetro soffiato	Code Codice	Euro €
Sphere Ø 18 cm/7,08"	III Clear Trasparente	17113V 00	59,00
Sfera Ø 18 cm/7,08"	IV Frosted White Bianco Satinato	17113V 13	90,00
	V Glossy Smoke Fumo Lucido	17113V 43	90,00
	VI Pale Gold <b>NEW</b> Oro Chiaro <b>NEW</b>	17113V 45	90,00
	VII Glossy Bronze Bronzo Lucido	17113V 46	90,00
	VIII Mandarin Orange <b>NEW</b> Arancio Vivace <b>NEW</b>	17113V 58	90,00
	IX Golden Sage <b>NEW</b> Salvia Dorata <b>NEW</b>	17113V 71	90,00
	X Deep Azure Steel <b>NEW</b> Azzurro Met. Intenso <b>NEW</b>	17113V 86	90,00

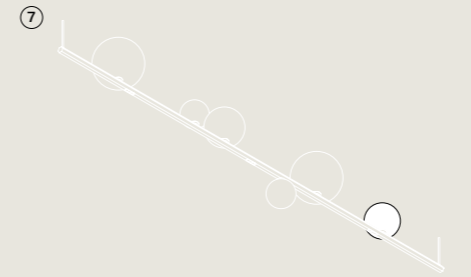

Description Descrizione	Blown glass diffuser Diffusore in vetro soffiato	Code Codice	Euro €
Sphere Ø 12 cm/4,72"	III Clear Trasparente	17111V 00	39,00
Sfera Ø 12 cm/4,72"	IV Frosted White Bianco Satinato	17111V 13	64,00
	V Glossy Smoke Fumo Lucido	17111V 43	64,00
	VI Pale Gold <b>NEW</b> Oro Chiaro <b>NEW</b>	17111V 45	64,00
	VII Glossy Bronze Bronzo Lucido	17111V 46	64,00
	VIII Mandarin Orange <b>NEW</b> Arancio Vivace <b>NEW</b>	17111V 58	64,00
	IX Golden Sage <b>NEW</b> Salvia Dorata <b>NEW</b>	17111V 71	64,00
	X Deep Azure Steel <b>NEW</b> Azzurro Met. Intenso <b>NEW</b>	17111V 86	64,00



Random Stick short

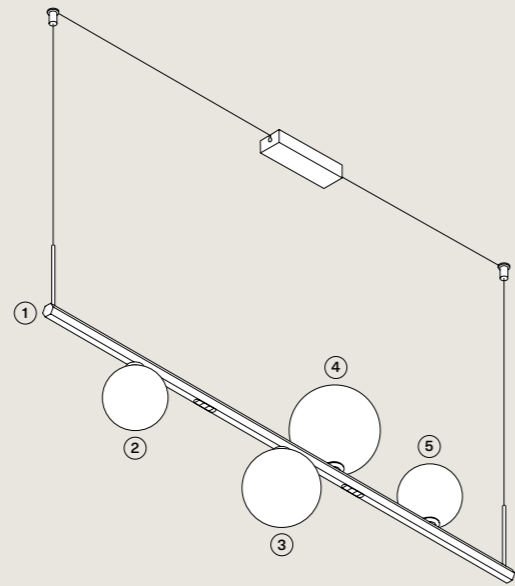

Create the product code  
Crea il codice prodotto

Structure 100		Sphere 10	Sphere 12	Sphere 14	Sphere 10			
2700 K	3000 K							
I 23420M 2227 23420M 2230 II 23420M 5027 23420M 5030	III	17110V 00	17111V 00	17112V 00	17110V 00			
	IV	17110V 13	17111V 13	17112V 13	17110V 13			
	V	17110V 43	17111V 43	17112V 43	17110V 43			
	VI	17110V 45	17111V 45	17112V 45	17110V 45			
	VII	17110V 46	17111V 46	17112V 46	17110V 46			
	VIII	17110V 58	17111V 58	17112V 58	17110V 58			
	IX	17110V 71	17111V 71	17112V 71	17110V 71			
	X	17110V 86	17111V 86	17112V 86	17110V 86			
	①	②	③	④	⑤			
	23420M ____	+	17110V __	+	17111V __	+	17112V __	+

I	Black Chrome	Cromo Nero	VI	Pale Gold	Oro Chiaro
II	Glossy Gold	Oro Lucido	VII	Glossy Bronze	Bronzo Lucido
III	Clear	Trasparente	VIII	Mandarin Orange	Arancio Vivace
IV	Frosted White	Bianco Satinato	IX	Golden Sage	Salvia Dorata
V	Glossy Smoke	Fumo Lucido	X	Deep Azure Steel	Azzurro Met. Intenso

Random Stick medium

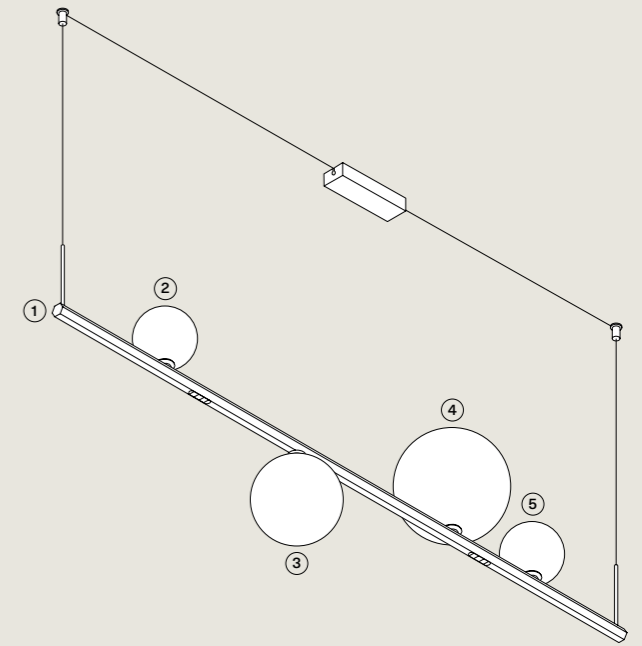

Create the product code  
Crea il codice prodotto

Structure 120		Sphere 10	Sphere 14	Sphere 18	Sphere 10			
2700 K	3000 K							
I 23424M 2227 23424M 2230 II 23424M 5027 23424M 5030	III	17110V 00	17112V 00	17113V 00	17110V 00			
	IV	17110V 13	17112V 13	17113V 13	17110V 13			
	V	17110V 43	17112V 43	17113V 43	17110V 43			
	VI	17110V 45	17112V 45	17113V 45	17110V 45			
	VII	17110V 46	17112V 46	17113V 46	17110V 46			
	VIII	17110V 58	17112V 58	17113V 58	17110V 58			
	IX	17110V 71	17112V 71	17113V 71	17110V 71			
	X	17110V 86	17112V 86	17113V 86	17110V 86			
	①	②	③	④	⑤			
	23424M ____	+	17110V __	+	17112V __	+	17111V __	+

I	Black Chrome	Cromo Nero	VI	Pale Gold	Oro Chiaro
II	Glossy Gold	Oro Lucido	VII	Glossy Bronze	Bronzo Lucido
III	Clear	Trasparente	VIII	Mandarin Orange	Arancio Vivace
IV	Frosted White	Bianco Satinato	IX	Golden Sage	Salvia Dorata
V	Glossy Smoke	Fumo Lucido	X	Deep Azure Steel	Azzurro Met. Intenso

# Random Stick long

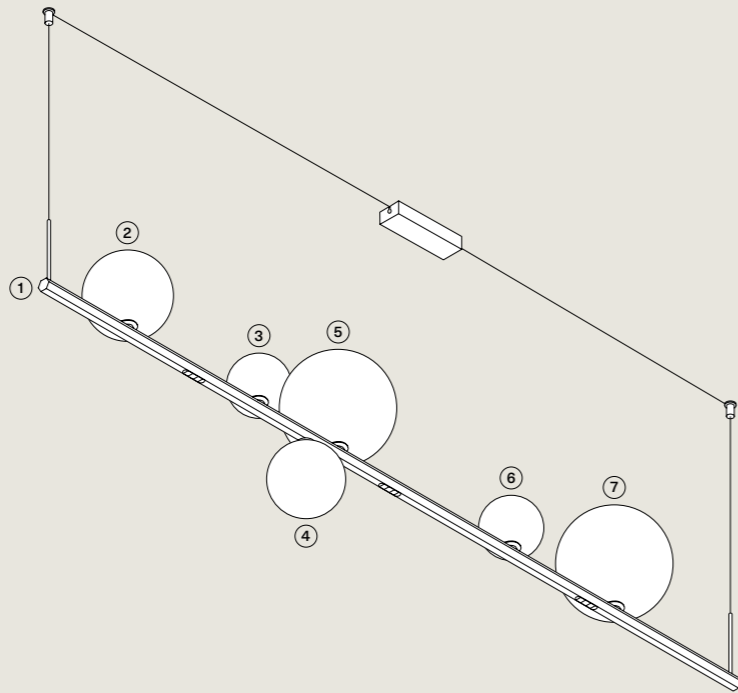

Create the product code  
Crea il codice prodotto

Structure 150		Sphere 14	Sphere 10	Sphere 12	Sphere 18	Sphere 10	Sphere 18						
I	2700 K	III	17112V 00	17110V 00	17111V 00	17113V 00	17110V 00	17113V 00					
	3000 K		17112V 13	17110V 13	17111V 13	17113V 13	17110V 13	17113V 13					
	23421M 2227		23421M 2230	17112V 43	17110V 43	17111V 43	17113V 43	17110V 43	17113V 43				
				17112V 45	17110V 45	17111V 45	17113V 45	17110V 45	17113V 45				
	II		VIII	17112V 46	17110V 46	17111V 46	17113V 46	17110V 46	17113V 46				
				17112V 58	17110V 58	17111V 58	17113V 58	17110V 58	17113V 58				
				23421M 5027	23421M 5030	17112V 71	17110V 71	17111V 71	17113V 71	17110V 71	17113V 71		
						17112V 86	17110V 86	17111V 86	17113V 86	17110V 86	17113V 86		
						②	③	④	⑤	⑥	⑦		
				23421M _____		+	17112V __	+	17110V __	+	17111V __	+	17113V __

I	Black Chrome	Cromo Nero	VI	Pale Gold	Oro Chiaro
II	Glossy Gold	Oro Lucido	VII	Glossy Bronze	Bronzo Lucido
III	Clear	Trasparente	VIII	Mandarin Orange	Arancio Vivace
IV	Frosted White	Bianco Satinato	IX	Golden Sage	Salvia Dorata
V	Glossy Smoke	Fumo Lucido	X	Deep Azure Steel	Azzurro Met. Intenso

# Random Stick xl

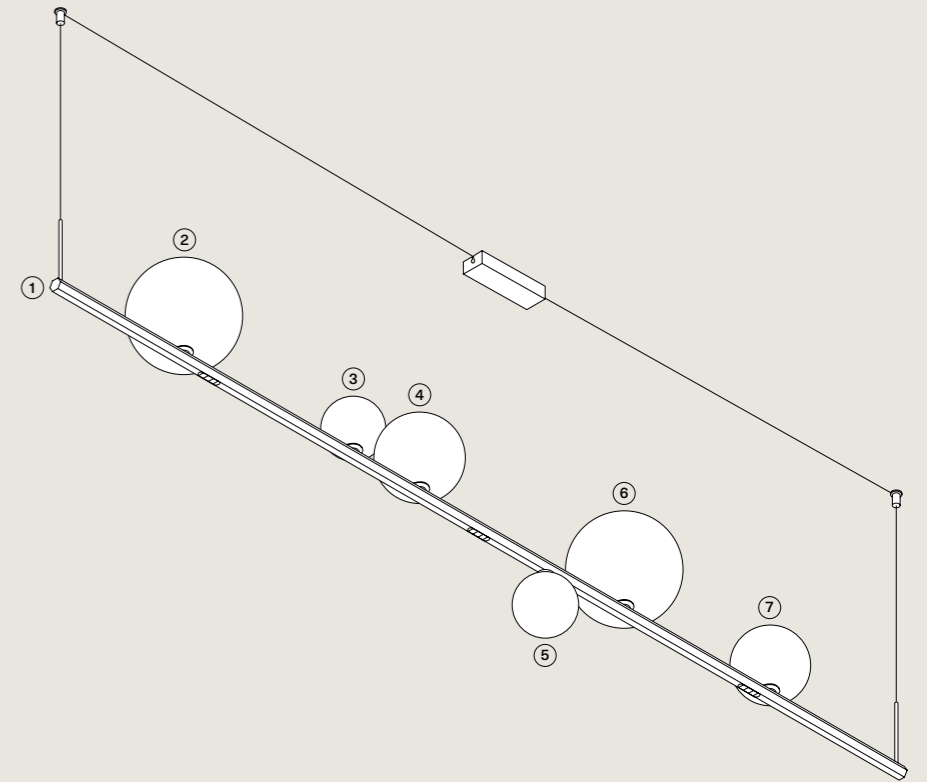

Create the product code  
Crea il codice prodotto

Structure 180		Sphere 18	Sphere 10	Sphere 14	Sphere 10	Sphere 18	Sphere 12						
I	2700 K	III	17113V 00	17110V 00	17112V 00	17110V 00	17113V 00	17111V 00					
	3000 K		17113V 13	17110V 13	17112V 13	17110V 13	17113V 13	17111V 13					
	23425M 2227		23425M 2230	17113V 43	17110V 43	17112V 43	17110V 43	17113V 43	17111V 43				
				17113V 45	17110V 45	17112V 45	17110V 45	17113V 45	17111V 45				
	II		VIII	17113V 46	17110V 46	17112V 46	17110V 46	17113V 46	17111V 46				
				17113V 58	17110V 58	17112V 58	17110V 58	17113V 58	17111V 58				
				23425M 5027	23425M 5030	17113V 71	17110V 71	17112V 71	17110V 71	17113V 71	17111V 71		
						17113V 86	17110V 86	17112V 86	17110V 86	17113V 86	17111V 86		
						②	③	④	⑤	⑥	⑦		
				23425M _____		+	17113V __	+	17110V __	+	17112V __	+	17110V __

I	Black Chrome	Cromo Nero	VI	Pale Gold	Oro Chiaro
II	Glossy Gold	Oro Lucido	VII	Glossy Bronze	Bronzo Lucido
III	Clear	Trasparente	VIII	Mandarin Orange	Arancio Vivace
IV	Frosted White	Bianco Satinato	IX	Golden Sage	Salvia Dorata
V	Glossy Smoke	Fumo Lucido	X	Deep Azure Steel	Azzurro Met. Intenso

# Tidal

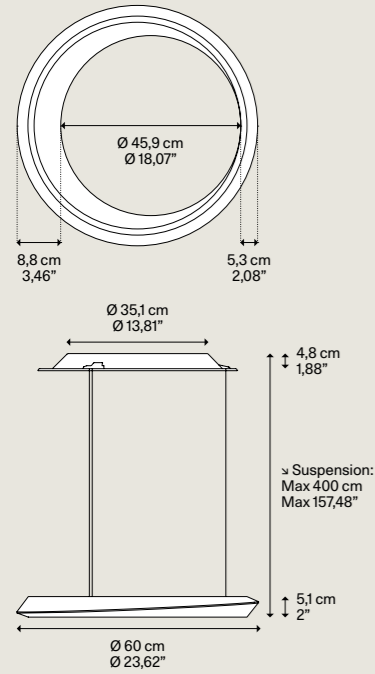

Light source <b>A</b> Sorgente luminosa		Light source <b>B</b> Sorgente luminosa	
LED	K	LED	K
2700	33	3000	33
	W		W
6120	lm	6630	lm
350+350	mA	350+350	mA
CRI 90		CRI 90	
MacAdam 3-Step		MacAdam 3-Step	
LED and driver included LED e driver inclusi		LED and driver included LED e driver inclusi	
Double switch Doppia accensione		Double switch Doppia accensione	

Net weight	8,20 kg	Pack	2	Energy class	C
Peso netto	18,07 lbs	Colli		Classe energetica	



SUSPENSION				VAT excluded IVA esclusa
Metal structure Montatura in metallo	Round canopy Rosone rotondo	Code Codice	Code Codice	Euro €
Matte White - 9010 Bianco Opaco - 9010		19921 1027	19921 1030	1.260,00
Matte Black - 9005 Nero Opaco - 9005		19921 2027	19921 2030	1.260,00
Extra Matte Champagne Champagne Extra Opaco	Matte White - 9010 Bianco Opaco - 9010	19921 4527	19921 4530	1.290,00
Extra Matte Terra Terra Extra Opaco		19921 6727	19921 6730	1.320,00
Matte White - 9010 Bianco Opaco - 9010		19922 1027	19922 1030	1.260,00
Matte Black - 9005 Nero Opaco - 9005		19922 2027	19922 2030	1.260,00
Extra Matte Champagne Champagne Extra Opaco	Matte Black - 9005 Nero Opaco - 9005	19922 4527	19922 4530	1.290,00
Extra Matte Terra Terra Extra Opaco		19922 6727	19922 6730	1.320,00

SUSPENSION				VAT excluded IVA esclusa
Metal structure Montatura in metallo	Round canopy Rosone rotondo	Code Codice	Code Codice	Euro €
Matte White - 9010 Bianco Opaco - 9010		19925 1027	19925 1030	1.360,00
Matte Black - 9005 Nero Opaco - 9005		19925 2027	19925 2030	1.360,00
Extra Matte Champagne Champagne Extra Opaco	Matte White - 9010 Bianco Opaco - 9010	19925 4527	19925 4530	1.390,00
Extra Matte Terra Terra Extra Opaco		19925 6727	19925 6730	1.420,00
Matte White - 9010 Bianco Opaco - 9010		19926 1027	19926 1030	1.360,00
Matte Black - 9005 Nero Opaco - 9005		19926 2027	19926 2030	1.360,00
Extra Matte Champagne Champagne Extra Opaco	Matte Black - 9005 Nero Opaco - 9005	19926 4527	19926 4530	1.390,00
Extra Matte Terra Terra Extra Opaco		19926 6727	19926 6730	1.420,00

# Tidal

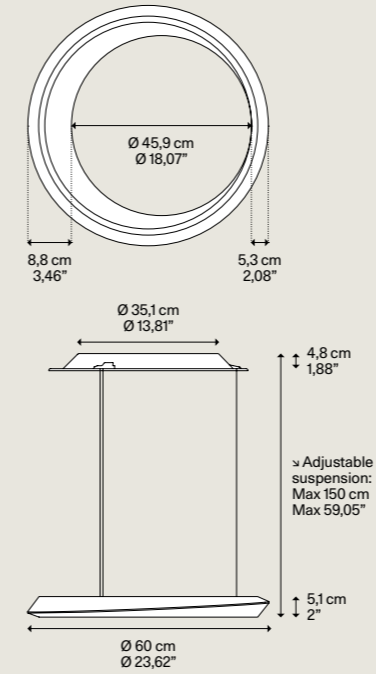

Light source <b>A</b> Sorgente luminosa		Light source <b>B</b> Sorgente luminosa	
LED	K	LED	K
2700	33	3000	33
	W		W
6120	lm	6630	lm
350+350	mA	350+350	mA
CRI 90		CRI 90	
MacAdam 3-Step		MacAdam 3-Step	
LED and driver included LED e driver inclusi		LED and driver included LED e driver inclusi	
Double switch Doppia accensione		Double switch Doppia accensione	

Net weight	8,50 kg	Pack	2	Energy class	C
Peso netto	18,73 lbs	Colli		Classe energetica	



ADJUSTABLE SUSPENSION				VAT excluded IVA esclusa
Metal structure Montatura in metallo	Round canopy Rosone rotondo	Code Codice	Code Codice	Euro €
Matte White - 9010 Bianco Opaco - 9010		19923 1027	19923 1030	1.460,00
Matte Black - 9005 Nero Opaco - 9005		19923 2027	19923 2030	1.460,00
Extra Matte Champagne Champagne Extra Opaco	Matte White - 9010 Bianco Opaco - 9010	19923 4527	19923 4530	1.490,00
Extra Matte Terra Terra Extra Opaco		19923 6727	19923 6730	1.520,00
Matte White - 9010 Bianco Opaco - 9010		19924 1027	19924 1030	1.460,00
Matte Black - 9005 Nero Opaco - 9005		19924 2027	19924 2030	1.460,00
Extra Matte Champagne Champagne Extra Opaco	Matte Black - 9005 Nero Opaco - 9005	19924 4527	19924 4530	1.490,00
Extra Matte Terra Terra Extra Opaco		19924 6727	19924 6730	1.520,00

ADJUSTABLE SUSPENSION				VAT excluded IVA esclusa
Metal structure Montatura in metallo	Round canopy Rosone rotondo	Code Codice	Code Codice	Euro €
Matte White - 9010 Bianco Opaco - 9010		19927 1027	19927 1030	1.560,00
Matte Black - 9005 Nero Opaco - 9005		19927 2027	19927 2030	1.560,00
Extra Matte Champagne Champagne Extra Opaco	Matte White - 9010 Bianco Opaco - 9010	19927 4527	19927 4530	1.590,00
Extra Matte Terra Terra Extra Opaco		19927 6727	19927 6730	1.620,00
Matte White - 9010 Bianco Opaco - 9010		19928 1027	19928 1030	1.560,00
Matte Black - 9005 Nero Opaco - 9005		19928 2027	19928 2030	1.560,00
Extra Matte Champagne Champagne Extra Opaco	Matte Black - 9005 Nero Opaco - 9005	19928 4527	19928 4530	1.590,00
Extra Matte Terra Terra Extra Opaco		19928 6727	19928 6730	1.620,00

## Light emission Emissione luminosa

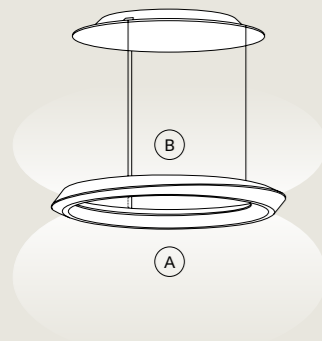

		Tidal	
<b>A</b> Direct light emission Emissione di luce diretta	2700 K	3060 lm	
	3000 K	3315 lm	
<b>B</b> Indirect light emission Emissione di luce indiretta	2700 K	3060 lm	
	3000 K	3315 lm	

## Adjustable suspension Sospensione saliscendi

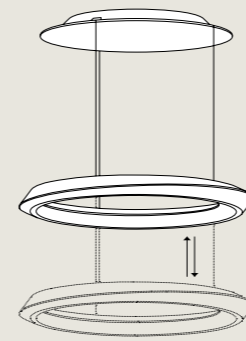

### Sky-Fall medium

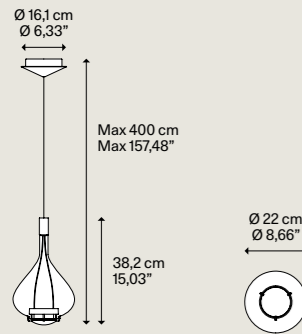

Light source Sorgente luminosa		Light source Sorgente luminosa	
A		B	
LED	K	LED	K
2700	12	3000	12
1877	1m	1975	1m
350	350 mA	350	350 mA
CRI 90		CRI 90	
MacAdam 2-Step		MacAdam 2-Step	
LED and driver included LED e driver inclusi		LED and driver included LED e driver inclusi	

Blown glass diffuser Diffusore in vetro soffiato	Metal structure Montatura in metallo	Code Codice	Code Codice	Euro €
		A	B	
Clear Trasparente		14825 0027	14825 0030	582,00
Glossy Smoke Fumo Lucido		14825 4327	14825 4330	709,00
Pale Gold <b>NEW</b> Oro Chiaro		14825 4527	14825 4530	709,00
Glossy Bronze Bronzo Lucido	Chrome Cromo	14825 4627	14825 4630	709,00
Golden Sage Salvia Dorata		14825 7127	14825 7130	709,00
Deep Azure Steel <b>NEW</b> Azzurro Met. Intenso	Transparent cable Cavo Trasparente	14825 8627	14825 8630	709,00
Clear Trasparente		14826 0027	14826 0030	582,00
Glossy Smoke Fumo Lucido		14826 4327	14826 4330	709,00
Pale Gold <b>NEW</b> Oro Chiaro		14826 4527	14826 4530	709,00
Glossy Bronze Bronzo Lucido	Black Chrome <b>NEW</b> Cromo Nero	14826 4627	14826 4630	709,00
Golden Sage Salvia Dorata		14826 7127	14826 7130	709,00
Deep Azure Steel <b>NEW</b> Azzurro Met. Intenso	Black cable Cavo Nero	14826 8627	14826 8630	709,00

Net weight Peso netto	1,99 kg 4,38 lbs	Pack Colli	2	Energy class Classe energetica	2700 K ▶ E 3000 K ▶ D
--------------------------	---------------------	---------------	---	-----------------------------------	--------------------------

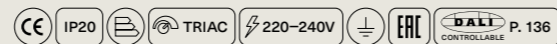

### Sky-Fall Round medium

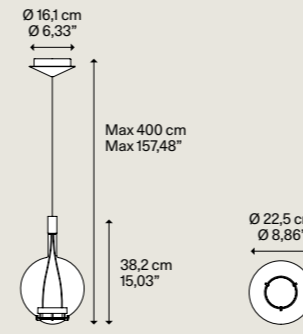

Light source Sorgente luminosa		Light source Sorgente luminosa	
A		B	
LED	K	LED	K
2700	12	3000	12
1877	1m	1975	1m
350	350 mA	350	350 mA
CRI 90		CRI 90	
MacAdam 2-Step		MacAdam 2-Step	
LED and driver included LED e driver inclusi		LED and driver included LED e driver inclusi	

Blown glass diffuser Diffusore in vetro soffiato	Metal structure Montatura in metallo	Code Codice	Code Codice	Euro €
		A	B	
Clear Trasparente		14815 0027	14815 0030	607,00
Glossy Smoke Fumo Lucido		14815 4327	14815 4330	745,00
Pale Gold <b>NEW</b> Oro Chiaro		14815 4527	14815 4530	745,00
Glossy Bronze Bronzo Lucido	Chrome Cromo	14815 4627	14815 4630	745,00
Golden Sage Salvia Dorata		14815 7127	14815 7130	745,00
Deep Azure Steel <b>NEW</b> Azzurro Met. Intenso	Transparent cable Cavo Trasparente	14815 8627	14815 8630	745,00
Clear Trasparente		14816 0027	14816 0030	607,00
Glossy Smoke Fumo Lucido		14816 4327	14816 4330	745,00
Pale Gold <b>NEW</b> Oro Chiaro		14816 4527	14816 4530	745,00
Glossy Bronze Bronzo Lucido	Black Chrome <b>NEW</b> Cromo Nero	14816 4627	14816 4630	745,00
Golden Sage Salvia Dorata		14816 7127	14816 7130	745,00
Deep Azure Steel <b>NEW</b> Azzurro Met. Intenso	Black cable Cavo Nero	14816 8627	14816 8630	745,00

Net weight Peso netto	1,80 kg 3,96 lbs	Pack Colli	2	Energy class Classe energetica	2700 K ▶ E 3000 K ▶ D
--------------------------	---------------------	---------------	---	-----------------------------------	--------------------------

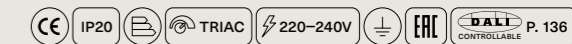

### Sky-Fall large

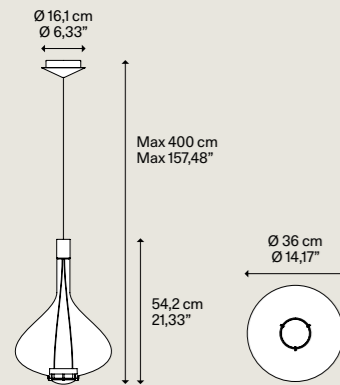

Light source Sorgente luminosa		Light source Sorgente luminosa	
A		B	
LED	K	LED	K
2700	12	3000	12
1877	1m	1975	1m
350	350 mA	350	350 mA
CRI 90		CRI 90	
MacAdam 2-Step		MacAdam 2-Step	
LED and driver included LED e driver inclusi		LED and driver included LED e driver inclusi	

Blown glass diffuser Diffusore in vetro soffiato	Metal structure Montatura in metallo	Code Codice	Code Codice	Euro €
		A	B	
Clear Trasparente		14827 0027	14827 0030	800,00
Glossy Smoke Fumo Lucido		14827 4327	14827 4330	1.082,00
Pale Gold <b>NEW</b> Oro Chiaro		14827 4527	14827 4530	1.082,00
Glossy Bronze Bronzo Lucido	Chrome Cromo	14827 4627	14827 4630	1.082,00
Golden Sage Salvia Dorata		14827 7127	14827 7130	1.082,00
Deep Azure Steel <b>NEW</b> Azzurro Met. Intenso	Transparent cable Cavo Trasparente	14827 8627	14827 8630	1.082,00
Clear Trasparente		14828 0027	14828 0030	800,00
Glossy Smoke Fumo Lucido		14828 4327	14828 4330	1.082,00
Pale Gold <b>NEW</b> Oro Chiaro		14828 4527	14828 4530	1.082,00
Glossy Bronze Bronzo Lucido	Black Chrome <b>NEW</b> Cromo Nero	14828 4627	14828 4630	1.082,00
Golden Sage Salvia Dorata		14828 7127	14828 7130	1.082,00
Deep Azure Steel <b>NEW</b> Azzurro Met. Intenso	Black cable Cavo Nero	14828 8627	14828 8630	1.082,00

Net weight Peso netto	3,17 kg 6,98 lbs	Pack Colli	2	Energy class Classe energetica	2700 K ▶ E 3000 K ▶ D
--------------------------	---------------------	---------------	---	-----------------------------------	--------------------------

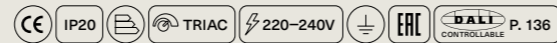

### Sky-Fall Round large

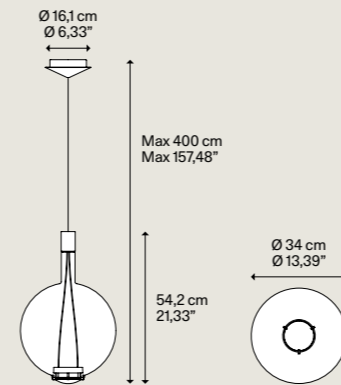

Light source Sorgente luminosa		Light source Sorgente luminosa	
A		B	
LED	K	LED	K
2700	12	3000	12
1877	1m	1975	1m
350	350 mA	350	350 mA
CRI 90		CRI 90	
MacAdam 2-Step		MacAdam 2-Step	
LED and driver included LED e driver inclusi		LED and driver included LED e driver inclusi	

Blown glass diffuser Diffusore in vetro soffiato	Metal structure Montatura in metallo	Code Codice	Code Codice	Euro €
		A	B	
Clear Trasparente		14817 0027	14817 0030	842,00
Glossy Smoke Fumo Lucido		14817 4327	14817 4330	1.133,00
Pale Gold <b>NEW</b> Oro Chiaro		14817 4527	14817 4530	1.133,00
Glossy Bronze Bronzo Lucido	Chrome Cromo	14817 4627	14817 4630	1.133,00
Golden Sage Salvia Dorata		14817 7127	14817 7130	1.133,00
Deep Azure Steel <b>NEW</b> Azzurro Met. Intenso	Transparent cable Cavo Trasparente	14817 8627	14817 8630	1.133,00
Clear Trasparente		14818 0027	14818 0030	842,00
Glossy Smoke Fumo Lucido		14818 4327	14818 4330	1.133,00
Pale Gold <b>NEW</b> Oro Chiaro		14818 4527	14818 4530	1.133,00
Glossy Bronze Bronzo Lucido	Black Chrome <b>NEW</b> Cromo Nero	14818 4627	14818 4630	1.133,00
Golden Sage Salvia Dorata		14818 7127	14818 7130	1.133,00
Deep Azure Steel <b>NEW</b> Azzurro Met. Intenso	Black cable Cavo Nero	14818 8627	14818 8630	1.133,00

Net weight Peso netto	2,76 kg 6,08 lbs	Pack Colli	2	Energy class Classe energetica	2700 K ▶ E 3000 K ▶ D
--------------------------	---------------------	---------------	---	-----------------------------------	--------------------------



## Sky-Fall double canopy

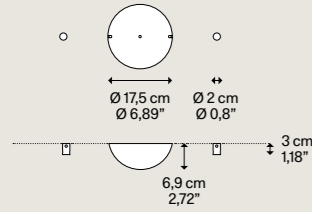

Net weight	0,56 kg	Pack	1
Peso netto	1,23 lbs	Colli	

### Description

Canopy with dual side outlets for installing two suspensions from a single electrical point.

Rosone con doppia uscita laterale per l'installazione di due lampade da un unico punto di alimentazione.

### Metal structure

- Black Chrome Cromo Nero
- Chrome Cromo

### Code

R99L02 2000	215,00
R99L02 4000	215,00

VAT excluded  
IVA esclusa



## Volum 42

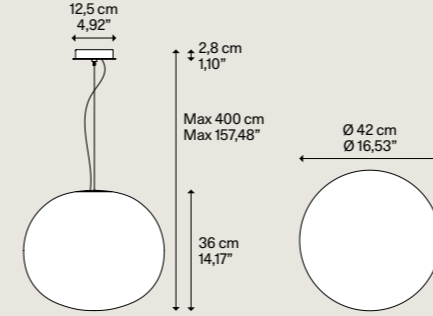

Net weight	3,64 kg	Pack	2
Peso netto	8,02 lbs	Colli	

VAT excluded  
IVA esclusa

### Methacrylate structure

- Glossy White Bianco Lucido

### Blown glass diffuser

- Glossy White Bianco Lucido

### Code

18720 1200	520,00
------------	--------

### Light source

Sorgente luminosa  
E27 LED T35 1x 21 W (max 25 W) Ø max 9,8 cm Ø max 3,74"

Light bulb to be ordered separately  
Lampadina da ordinare separatamente



### PREVIOUS VERSION

Metal structure Montatura in metallo	Blown glass diffuser Diffusore in vetro soffiato	Sky-Fall medium *		Sky-Fall large *		Sky-Fall Round medium *		Sky-Fall Round large *	
		2700 K <b>A</b>	3000 K <b>B</b>	2700 K <b>A</b>	3000 K <b>B</b>	2700 K <b>A</b>	3000 K <b>B</b>	2700 K <b>A</b>	3000 K <b>B</b>
Chrome Cromo	Clear Trasparente	14822 0027	14822 0030	14821 0027	14821 0030	14824 0027	14824 0030	14823 0027	14823 0030
	Glossy Smoke Fumo Lucido	14822 4327	14822 4330	14821 4327	14821 4330	14824 4327	14824 4330	14823 4327	14823 4330
	Glossy Bronze Bronzo Lucido	14822 4627	14822 4630	14821 4627	14821 4630	14824 4627	14824 4630	14823 4627	14823 4630
	Golden Sage Salvia Dorata	14822 7127	14822 7130	14821 7127	14821 7130	14824 7127	14824 7130	14823 7127	14823 7130

► \* Available while stocks last.

► \* Disponibile fino ad esaurimento scorte.

### Light source

Sorgente luminosa  
E27 LED T35 21 W  $\square$  2700 K 2010 lm CRI 90 MacAdam 3-Step

### Bulb dimension

Dimensione lampadina  
Ø 3,5 cm W/L 15 cm  
Ø 1,37" W/L 5,90"

### Lamp

Lampada  
Volum 42

### Pack

Colli  
1

### Code

Code  
LAM-0016

VAT excluded  
IVA esclusa

### Euro €

48,00

Dimmable bulbs/Lampadine dimmerabili

# Cluster suspension lamps



CATEGORY CLUSTER SUSPENSION LAMP

DESIGN Studio Italia Design, 2013

VAT excluded  
IVA esclusa

## A-Tube small

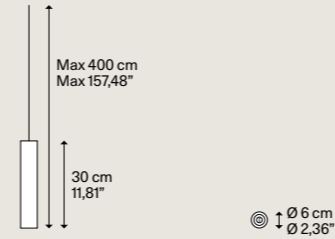

Net weight 1,12 kg / 2,47 lbs  
Pack 1 / Colli 1

### Light source Sorgente luminosa

GU10 Par 16 LED  
1x 10 W

W/L max 8,5 cm  
W/L max 3,34"

Bulb not included  
Lampadina non inclusa

### Metal structure Montatura in metallo

Matte White - 9010  
Bianco Opaco - 9010

Matte Black - 9005  
Nero Opaco - 9005

Matte Champagne NEW  
Champagne Opaco

Natural Brown NCS S 8005-Y50R NEW  
Testa di Moro NCS S 8005-Y50R

Code  
Codice

09622 1000

09622 2000

09622 4500

09622 6900

Euro €

174,00

174,00

179,00

179,00

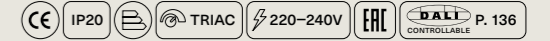

## A-Tube medium

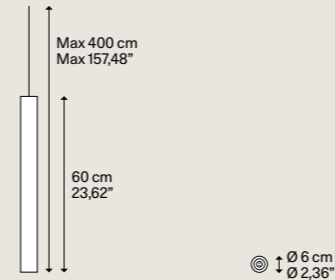

Net weight 1,42 kg / 3,13 lbs  
Pack 1 / Colli 1

### Light source Sorgente luminosa

GU10 Par 16 LED  
1x 10 W

W/L max 8,5 cm  
W/L max 3,34"

Bulb not included  
Lampadina non inclusa

### Metal structure Montatura in metallo

Matte White - 9010  
Bianco Opaco - 9010

Matte Black - 9005  
Nero Opaco - 9005

Matte Champagne NEW  
Champagne Opaco

Natural Brown NCS S 8005-Y50R NEW  
Testa di Moro NCS S 8005-Y50R

Code  
Codice

09623 1000

09623 2000

09623 4500

09623 6900

VAT excluded  
IVA esclusa

250,00

250,00

265,00

265,00

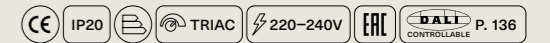

## A-Tube large

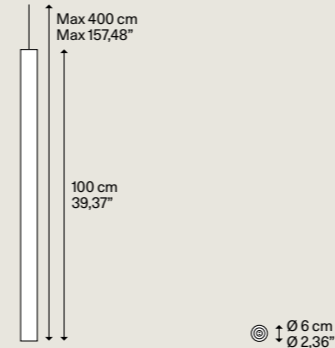

Net weight 1,87 kg / 4,12 lbs  
Pack 1 / Colli 1

### Light source Sorgente luminosa

GU10 Par 16 LED  
1x 10 W

W/L max 8,5 cm  
W/L max 3,34"

Bulb not included  
Lampadina non inclusa

### Metal structure Montatura in metallo

Matte White - 9010  
Bianco Opaco - 9010

Matte Black - 9005  
Nero Opaco - 9005

Matte Champagne NEW  
Champagne Opaco

Natural Brown NCS S 8005-Y50R NEW  
Testa di Moro NCS S 8005-Y50R

Code  
Codice

09624 1000

09624 2000

09624 4500

09624 6900

VAT excluded  
IVA esclusa

347,00

347,00

368,00

368,00

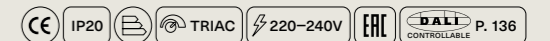

The lamps must be installed on canopies ▶ p. 060-067  
Le lampade devono essere installate su rosoni ▶ p. 060-067

### A-Tube Nano small

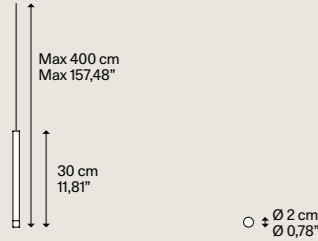

Metal structure Montatura in metallo	Methacrylate diffuser Diffusore in metacrilato	Code Codice	Code Codice	Euro €
● Matte Black - 9005 Nero Opaco - 9005		15822 2020	15822 2035	154,00
● Matte Champagne Champagne Opaco	○ Clear Trasparente	15822 4520	15822 4535	159,00
● Gold Oro		15822 5020	15822 5035	179,00
● Terra Terra	⊕ Transparent cable Cavo trasparente	15822 6720	15822 6735	174,00
● Matte Black - 9005 Nero Opaco - 9005		15826 2020	15826 2035	154,00
● Matte Champagne Champagne Opaco	○ Clear Trasparente	15826 4520	15826 4535	159,00
● Gold Oro		15826 5020	15826 5035	179,00
● Terra Terra	⊕ Black cable Cavo nero	15826 6720	15826 6735	174,00

**Light source**  
Sorgente luminosa

**A**

LED	
2700	K
3	W
450	lm
350	mA
CRI 90	
MacAdam 3-Step	

LED and driver included  
LED e driver inclusi

**Light source**  
Sorgente luminosa

**B**

LED	
3000	K
3	W
480	lm
350	mA
CRI 90	
MacAdam 3-Step	

LED and driver included  
LED e driver inclusi

Net weight Peso netto	0,22 kg 0,48 lbs	Pack Colli	2	Energy class Classe energetica	D
--------------------------	---------------------	---------------	---	-----------------------------------	---



### A-Tube Nano medium

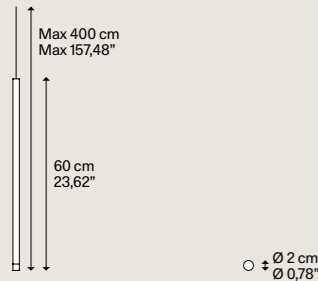

Metal structure Montatura in metallo	Methacrylate diffuser Diffusore in metacrilato	Code Codice	Code Codice	Euro €
● Matte Black - 9005 Nero Opaco - 9005		15823 2020	15823 2035	169,00
● Matte Champagne Champagne Opaco	○ Clear Trasparente	15823 4520	15823 4535	179,00
● Gold Oro		15823 5020	15823 5035	204,00
● Terra Terra	⊕ Transparent cable Cavo trasparente	15823 6720	15823 6735	194,00
● Matte Black - 9005 Nero Opaco - 9005		15827 2020	15827 2035	169,00
● Matte Champagne Champagne Opaco	○ Clear Trasparente	15827 4520	15827 4535	179,00
● Gold Oro		15827 5020	15827 5035	204,00
● Terra Terra	⊕ Black cable Cavo nero	15827 6720	15827 6735	194,00

**Light source**  
Sorgente luminosa

**A**

LED	
2700	K
3	W
450	lm
350	mA
CRI 90	
MacAdam 3-Step	

LED and driver included  
LED e driver inclusi

**Light source**  
Sorgente luminosa

**B**

LED	
3000	K
3	W
480	lm
350	mA
CRI 90	
MacAdam 3-Step	

LED and driver included  
LED e driver inclusi

Net weight Peso netto	0,30 kg 0,66 lbs	Pack Colli	2	Energy class Classe energetica	D
--------------------------	---------------------	---------------	---	-----------------------------------	---

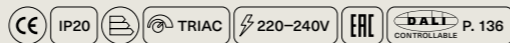

The lamps must be installed on canopies ▶ p. 060-067 or on the DOUBLEZERO7 System ▶ p. 102-123  
Le lampade devono essere installate su rosoni ▶ p. 060-067 o su sistema DOUBLEZERO7 ▶ p. 102-123

### A-Tube Nano large

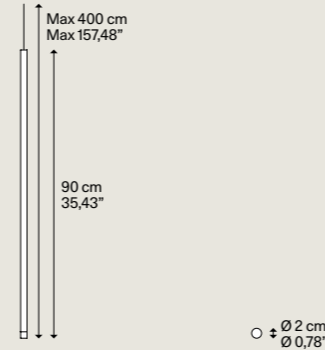

Metal structure Montatura in metallo	Methacrylate diffuser Diffusore in metacrilato	Code Codice	Code Codice	Euro €
● Matte Black - 9005 Nero Opaco - 9005		15824 2020	15824 2035	179,00
● Matte Champagne Champagne Opaco	○ Clear Trasparente	15824 4520	15824 4535	189,00
● Gold Oro		15824 5020	15824 5035	229,00
● Terra Terra	⊕ Transparent cable Cavo trasparente	15824 6720	15824 6735	214,00
● Matte Black - 9005 Nero Opaco - 9005		15828 2020	15828 2035	179,00
● Matte Champagne Champagne Opaco	○ Clear Trasparente	15828 4520	15828 4535	189,00
● Gold Oro		15828 5020	15828 5035	229,00
● Terra Terra	⊕ Black cable Cavo nero	15828 6720	15828 6735	214,00

**Light source**  
Sorgente luminosa

**A**

LED	
2700	K
3	W
450	lm
350	mA
CRI 90	
MacAdam 3-Step	

LED and driver included  
LED e driver inclusi

**Light source**  
Sorgente luminosa

**B**

LED	
3000	K
3	W
480	lm
350	mA
CRI 90	
MacAdam 3-Step	

LED and driver included  
LED e driver inclusi

Net weight Peso netto	0,40 kg 0,88 lbs	Pack Colli	2	Energy class Classe energetica	D
--------------------------	---------------------	---------------	---	-----------------------------------	---

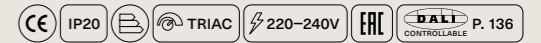

### A-Tube Nano xl

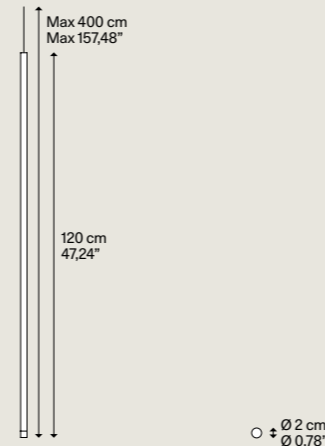

Metal structure Montatura in metallo	Methacrylate diffuser Diffusore in metacrilato	Code Codice	Code Codice	Euro €
● Matte Black - 9005 Nero Opaco - 9005		15821 2020	15821 2035	189,00
● Matte Champagne Champagne Opaco	○ Clear Trasparente	15821 4520	15821 4535	199,00
● Gold Oro		15821 5020	15821 5035	254,00
● Terra Terra	⊕ Transparent cable Cavo trasparente	15821 6720	15821 6735	234,00
● Matte Black - 9005 Nero Opaco - 9005		15829 2020	15829 2035	189,00
● Matte Champagne Champagne Opaco	○ Clear Trasparente	15829 4520	15829 4535	199,00
● Gold Oro		15829 5020	15829 5035	254,00
● Terra Terra	⊕ Black cable Cavo nero	15829 6720	15829 6735	234,00

**Light source**  
Sorgente luminosa

**A**

LED	
2700	K
3	W
450	lm
350	mA
CRI 90	
MacAdam 3-Step	

LED and driver included  
LED e driver inclusi

**Light source**  
Sorgente luminosa

**B**

LED	
3000	K
3	W
480	lm
350	mA
CRI 90	
MacAdam 3-Step	

LED and driver included  
LED e driver inclusi

Net weight Peso netto	0,50 kg 1,10 lbs	Pack Colli	2	Energy class Classe energetica	D
--------------------------	---------------------	---------------	---	-----------------------------------	---

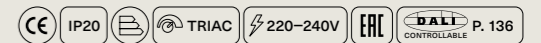

The lamps must be installed on canopies ▶ p. 060-067 or on the DOUBLEZERO7 System ▶ p. 102-123  
Le lampade devono essere installate su rosoni ▶ p. 060-067 o su sistema DOUBLEZERO7 ▶ p. 102-123

A-Tube Nano Duo

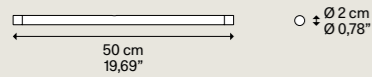
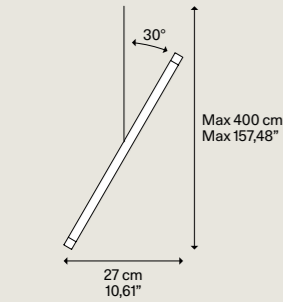

Metal structure Montatura in metallo	Methacrylate diffuser Diffusore in metacrilato	Code Codice	Euro €
● Matte Black - 9005 Nero Opaco - 9005		15825 2020	184,00
● Matte Champagne Matte Champagne		15825 4520	194,00
● Gold Oro	○ Clear Trasparente	15825 5020	225,00
● Terra Terra	○ Transparent cable Cavo trasparente	15825 6720	210,00

Light source  
Sorgente luminosa

LED  
2700 K  
2x 1 W  
280 lm  
350 mA  
CRI 90  
MacAdam 3-Step  
LED and driver included  
LED e driver inclusi

Net weight Peso netto	0,21 kg 0,46 lbs	Pack Colli	1	Energy class Classe energetica	D
--------------------------	---------------------	---------------	---	-----------------------------------	---

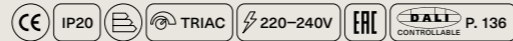

The lamps must be installed on canopies ▶ p. 060-067 or on the DOUBLEZERO7 System ▶ p. 102-123  
Le lampade devono essere installate su rosioni ▶ p. 060-067 o su sistema DOUBLEZERO7 ▶ p. 102-123

Cono di Luce large

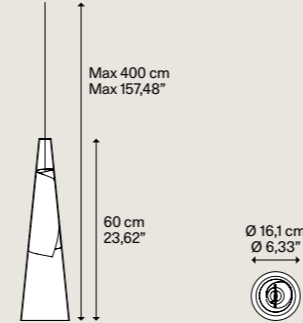

Outside blown glass diffuser Diffusore esterno in vetro soffiato	Inside PCB diffuser Diffusore interno in PCB	Code Codice	Euro €
○ Clear Trasparente	● Grey Grigio	21011 3227	470,00
	● Gold Oro	21011 5027	521,00
	● Red Rosso	21011 6027	470,00

Light source  
Sorgente luminosa

LED  
2700 K  
7 W  
1307 lm  
350 mA  
CRI 90  
MacAdam 3-Step  
LED and driver included  
LED e driver inclusi

Net weight Peso netto	1,12 kg 2,47 lbs	Pack Colli	3	Energy class Classe energetica	B
--------------------------	---------------------	---------------	---	-----------------------------------	---

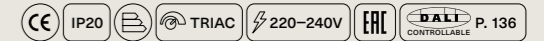

The lamps must be installed on canopies ▶ p. 060-067 or on the DOUBLEZERO7 System ▶ p. 102-123  
Le lampade devono essere installate su rosioni ▶ p. 060-067 o su sistema DOUBLEZERO7 ▶ p. 102-123

Cono di Luce small

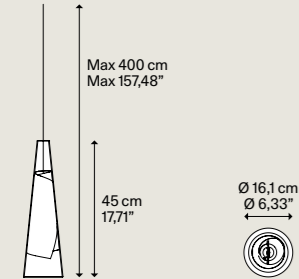

Outside blown glass diffuser Diffusore esterno in vetro soffiato	Inside PCB diffuser Diffusore interno in PCB	Code Codice	Euro €
○ Clear Trasparente	● Grey Grigio	21010 3227	368,00
	● Gold Oro	21010 5027	419,00
	● Red Rosso	21010 6027	368,00

Light source  
Sorgente luminosa

LED  
2700 K  
7 W  
1307 lm  
350 mA  
CRI 90  
MacAdam 3-Step  
LED and driver included  
LED e driver inclusi

Net weight Peso netto	0,73 kg 1,61 lbs	Pack Colli	3	Energy class Classe energetica	B
--------------------------	---------------------	---------------	---	-----------------------------------	---

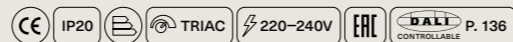

The lamps must be installed on canopies ▶ p. 060-067 or on the DOUBLEZERO7 System ▶ p. 102-123  
Le lampade devono essere installate su rosioni ▶ p. 060-067 o su sistema DOUBLEZERO7 ▶ p. 102-123

IVY I

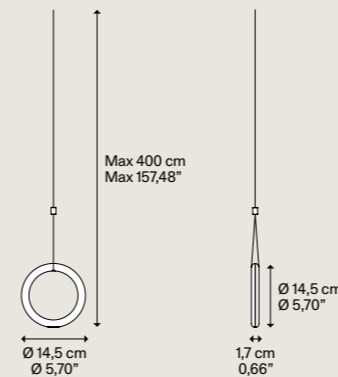

Metal structure Montatura in metallo	Cable Cavo	Code Codice	Code Codice	Euro €
● Matte Black - 9005 Nero Opaco - 9005		17810 2020	17810 2035	169,00
● Extra Matte Champagne Champagne Extra Opaco	○ Black Nero	17810 4520	17810 4535	180,00
● Extra Matte Terra Terra Extra Opaco		17810 6720	17810 6735	190,00

Light source  
Sorgente luminosa

LED  
2700 K  
3 W  
450 lm  
350 mA  
CRI 90  
MacAdam 3-Step  
LED and driver included  
LED e driver inclusi

Light source  
Sorgente luminosa

LED  
3000 K  
3 W  
480 lm  
350 mA  
CRI 90  
MacAdam 3-Step  
LED and driver included  
LED e driver inclusi

Net weight Peso netto	0,50 kg 1,10 lbs	Pack Colli	1	Energy class Classe energetica	2700 K ▶ D 3000 K ▶ C
--------------------------	---------------------	---------------	---	-----------------------------------	--------------------------

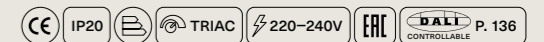

The lamps must be installed on canopies ▶ p. 060-067 or on the DOUBLEZERO7 System ▶ p. 102-123  
Le lampade devono essere installate su rosioni ▶ p. 060-067 o su sistema DOUBLEZERO7 ▶ p. 102-123

Jefferson mini

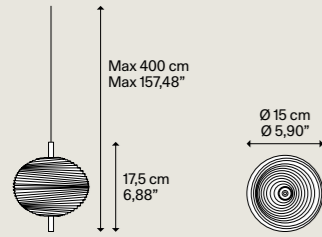

Metal structure Montatura in metallo	Bohemian crystal diffuser Diffusore in cristallo di Boemia	Code Codice	Euro €
Black Chrome Cromo Nero	Clear Trasparente	16821 4227	295,00
Gold Oro		16821 5027	310,00

Light source  
Sorgente luminosa

LED 2700 K  
3 W  
450 lm  
350 mA  
CRI 90  
MacAdam 3-Step

LED and driver included  
LED e driver inclusi

Net weight Peso netto	1,40 kg 3,09 lbs	Pack Colli	1	Energy class Classe energetica	D
--------------------------	---------------------	---------------	---	-----------------------------------	---

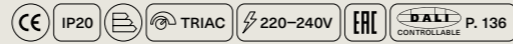

Jefferson small

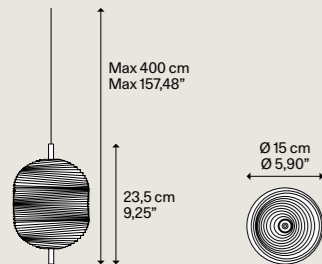

Metal structure Montatura in metallo	Bohemian crystal diffuser Diffusore in cristallo di Boemia	Code Codice	Euro €
Black Chrome Cromo Nero	Clear Trasparente	16822 4227	380,00
Gold Oro		16822 5027	395,00

Light source  
Sorgente luminosa

LED 2700 K  
3 W  
450 lm  
350 mA  
CRI 90  
MacAdam 3-Step

LED and driver included  
LED e driver inclusi

Net weight Peso netto	2,10 kg 4,63 lbs	Pack Colli	1	Energy class Classe energetica	D
--------------------------	---------------------	---------------	---	-----------------------------------	---

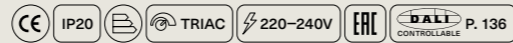

The lamps must be installed on canopies ▶ p. 060-067 or on the DOUBLEZERO7 System ▶ p. 102-123  
Le lampade devono essere installate su rosoni ▶ p. 060-067 o su sistema DOUBLEZERO7 ▶ p. 102-123

JIM bell \*

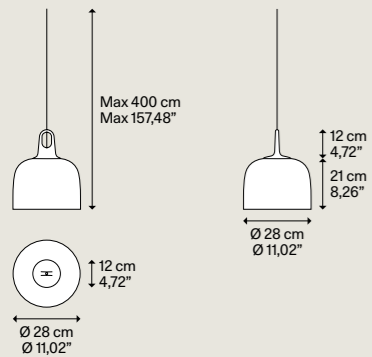

Outside metal diffuser Diff. esterno in metallo	Inside metal diffuser Diff. interno in metallo	Hook methacrylate Gancio in metacrilato	Code Codice	Euro €
Matte White - 9010 Bianco Opaco - 9010	Matte White - 9010 Bianco Opaco - 9010	Grey Grigio	16921 2300	322,00
		Honey Miele	16921 6300	322,00
Matte Black - 9005 Nero Opaco - 9005	Matte White - 9010 Bianco Opaco - 9010	Grey Grigio	16921 2800	322,00
		Honey Miele	16921 6600	322,00
Matte Champagne Champagne Opaco	Matte White - 9010 Bianco Opaco - 9010	Grey Grigio	16921 2700	332,00
		Honey Miele	16921 6500	332,00
Coppery Bronze Bronzo Ramato	Matte White - 9010 Bianco Opaco - 9010	Grey Grigio	16921 2400	332,00
		Honey Miele	16921 6400	332,00

Light source  
Sorgente luminosa

E27 A60 LED  
1x Max 25 W

Bulb not included  
Lampadina non inclusa

Net weight Peso netto	1,90 kg 4,19 lbs	Pack Colli	2
--------------------------	---------------------	---------------	---

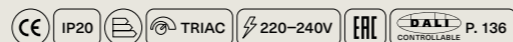

JIM cone \*

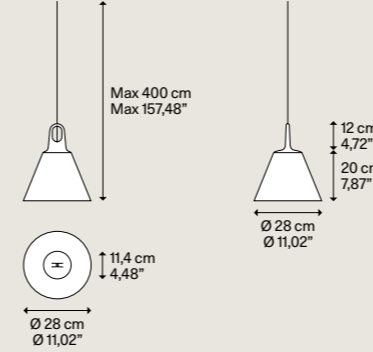

Light source  
Sorgente luminosa

E27 A60 LED  
1x Max 25 W

Bulb not included  
Lampadina non inclusa

Net weight Peso netto	1,00 kg 2,20 lbs	Pack Colli	2
--------------------------	---------------------	---------------	---



Outside metal diffuser Diff. esterno in metallo	Inside metal diffuser Diff. interno in metallo	Hook methacrylate Gancio in metacrilato	Code Codice	Euro €
Matte White - 9010 Bianco Opaco - 9010	Matte White - 9010 Bianco Opaco - 9010	Grey Grigio	16922 2300	276,00
		Honey Miele	16922 6300	276,00
Matte Black - 9005 Nero Opaco - 9005	Matte White - 9010 Bianco Opaco - 9010	Grey Grigio	16922 2800	276,00
		Honey Miele	16922 6600	276,00
Matte Champagne Champagne Opaco	Matte White - 9010 Bianco Opaco - 9010	Grey Grigio	16922 2700	286,00
		Honey Miele	16922 6500	286,00
Coppery Bronze Bronzo Ramato	Matte White - 9010 Bianco Opaco - 9010	Grey Grigio	16922 2400	286,00
		Honey Miele	16922 6400	286,00

JIM cylinder \*

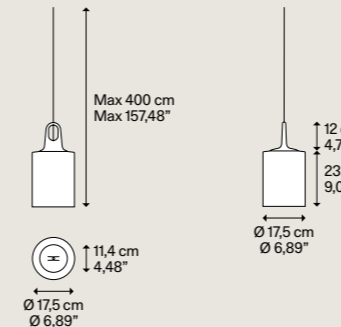

Light source  
Sorgente luminosa

E27 A60 LED  
1x Max 25 W

Bulb not included  
Lampadina non inclusa

Net weight Peso netto	1,40 kg 3,09 lbs	Pack Colli	2
--------------------------	---------------------	---------------	---

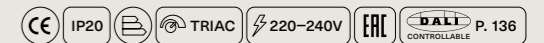

Outside metal diffuser Diff. esterno in metallo	Inside metal diffuser Diff. interno in metallo	Hook methacrylate Gancio in metacrilato	Code Codice	Euro €
Matte White - 9010 Bianco Opaco - 9010	Matte White - 9010 Bianco Opaco - 9010	Grey Grigio	16923 2300	290,00
		Honey Miele	16923 6300	290,00
Matte Black - 9005 Nero Opaco - 9005	Matte White - 9010 Bianco Opaco - 9010	Grey Grigio	16923 2800	290,00
		Honey Miele	16923 6600	290,00
Matte Champagne Champagne Opaco	Matte White - 9010 Bianco Opaco - 9010	Grey Grigio	16923 2700	300,00
		Honey Miele	16923 6500	300,00
Coppery Bronze Bronzo Ramato	Matte White - 9010 Bianco Opaco - 9010	Grey Grigio	16923 2400	300,00
		Honey Miele	16923 6400	300,00

The lamps must be installed on canopies ▶ p. 060-067 or on the DOUBLEZERO7 System ▶ p. 102-123  
Le lampade devono essere installate su rosoni ▶ p. 060-067 o su sistema DOUBLEZERO7 ▶ p. 102-123

### Kelly Cluster

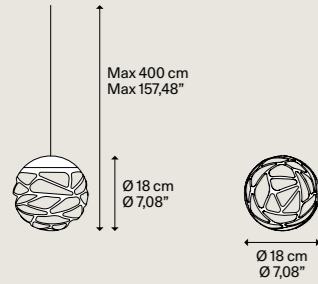

Metal structure Montatura in metallo	Glass diffuser Diffusore in vetro	Code Codice	Euro €
● Matte Black - 9005 Nero Opaco - 9005		14711 2027	388,00
● Matte Champagne Champagne Opaco	● Glossy White Bianco Lucido	14711 4527	403,00
● Natural Brown NCS S 8005-Y50R NEW Testa di Moro NCS S 8005-Y50R		14711 6927	403,00

**Light source  
Sorgente luminosa**

LED	
2700	K
7	W
1280	lm
350	mA
CRI 90	
MacAdam 3-Step	

LED and driver included  
LED e driver inclusi

Net weight Peso netto	1,00 kg 2,20 lbs	Pack Colli	1	Energy class Classe energetica	C
--------------------------	---------------------	---------------	---	-----------------------------------	---

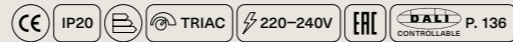

The lamps must be installed on canopies ▶ P. 060-067 or on the DOUBLEZERO7 System ▶ P. 102-123  
Le lampade devono essere installate su rosoni ▶ P. 060-067 o su sistema DOUBLEZERO7 ▶ P. 102-123

### Nostalgia small

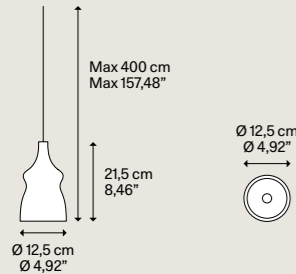

Metal structure Montatura in metallo	Blown glass diffuser Diffusore in vetro soffiato	Code Codice	Euro €
● Chrome Cromo	● Clear Trasparente	15412 0027	325,00
	● Glossy Smoke Fumo Lucido	15412 4327	390,00
	● Pale Gold NEW Oro Chiaro	15412 4527	390,00
	● Glossy Bronze Bronzo Lucido	15412 4627	390,00
	● Golden Sage NEW Salvia Dorata	15412 7127	390,00
● White fabric cable Cavo bianco in tessuto	● Clear Trasparente	15415 0027	325,00
	● Glossy Smoke Fumo Lucido	15415 4327	390,00
● Matte Black - 9005 Nero Opaco - 9005	● Pale Gold NEW Oro Chiaro	15415 4527	390,00
	● Glossy Bronze Bronzo Lucido	15415 4627	390,00
● Black fabric cable Cavo nero in tessuto	● Golden Sage NEW Salvia Dorata	15415 7127	390,00

**Light source  
Sorgente luminosa**

LED	
2700	K
7	W
1280	lm
350	mA
CRI 90	
MacAdam 3-Step	

LED and driver included  
LED e driver inclusi

Net weight Peso netto	0,66 kg 1,45 lbs	Pack Colli	2	Energy class Classe energetica	C
--------------------------	---------------------	---------------	---	-----------------------------------	---

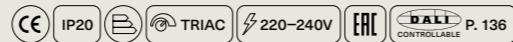

The lamps must be installed on canopies ▶ P. 060-067 or on the DOUBLEZERO7 System ▶ P. 102-123  
Le lampade devono essere installate su rosoni ▶ P. 060-067 o su sistema DOUBLEZERO7 ▶ P. 102-123

### Nostalgia medium

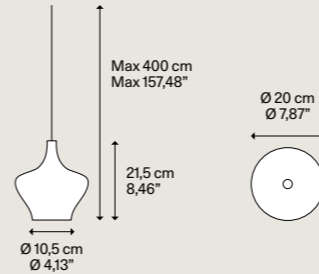

Metal structure Montatura in metallo	Blown glass diffuser Diffusore in vetro soffiato	Code Codice	Euro €
	● Clear Trasparente	15413 0027	370,00
	● Glossy Smoke Fumo Lucido	15413 4327	435,00
	● Pale Gold NEW Oro Chiaro	15413 4527	435,00
	● Glossy Bronze Bronzo Lucido	15413 4627	435,00
	● Golden Sage NEW Salvia Dorata	15413 7127	435,00
● White fabric cable Cavo bianco in tessuto	● Clear Trasparente	15416 0027	370,00
	● Glossy Smoke Fumo Lucido	15416 4327	435,00
● Matte Black - 9005 Nero Opaco - 9005	● Pale Gold NEW Oro Chiaro	15416 4527	435,00
	● Glossy Bronze Bronzo Lucido	15416 4627	435,00
● Black fabric cable Cavo nero in tessuto	● Golden Sage NEW Salvia Dorata	15416 7127	435,00

**Light source  
Sorgente luminosa**

LED	
2700	K
7	W
1280	lm
350	mA
CRI 90	
MacAdam 3-Step	

LED and driver included  
LED e driver inclusi

Net weight Peso netto	0,75 kg 1,65 lbs	Pack Colli	2	Energy class Classe energetica	C
--------------------------	---------------------	---------------	---	-----------------------------------	---



The lamps must be installed on canopies ▶ P. 060-067 or on the DOUBLEZERO7 System ▶ P. 102-123  
Le lampade devono essere installate su rosoni ▶ P. 060-067 o su sistema DOUBLEZERO7 ▶ P. 102-123

Oblò small

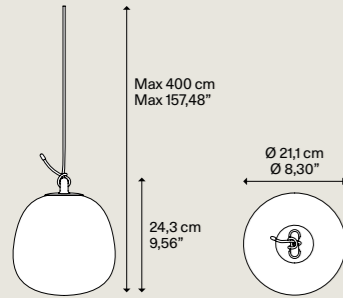

Silicone hook Gancio in silicone	Blown glass diffuser Diffusore in vetro soffiato	Code Codice	Code Codice	Euro €
White Bianco	Clear Trasparente	21811 0027	21811 0030	330,00
	Silk White Bianco Seta	21811 1327	21811 1330	450,00
	Rainbow Iridescente	21811 0127	21811 0130	550,00
	Glossy Smoke Fumo Lucido	21811 4327	21811 4330	450,00
	Azure Steel Azzurro Metallizzato	21811 8627	21811 8630	450,00

**Light source  
Sorgente luminosa**

**LED**  
2700 K  
7 W  
1280 lm  
350 mA  
CRI 90  
MacAdam 3-Step

LED and driver included  
LED e driver inclusi

**Light source  
Sorgente luminosa**

**LED**  
3000 K  
7 W  
1300 lm  
350 mA  
CRI 90  
MacAdam 3-Step

LED and driver included  
LED e driver inclusi

Net weight 0,64 kg / Peso netto 1,41 lbs  
Pack Colli 2  
Energy class Classe energetica D

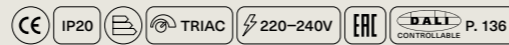

Oblò medium

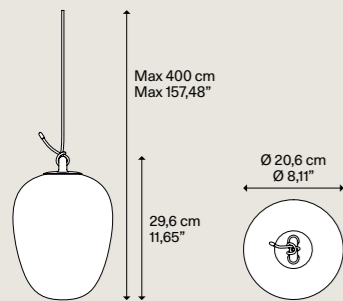

Silicone hook Gancio in silicone	Blown glass diffuser Diffusore in vetro soffiato	Code Codice	Code Codice	Euro €
White Bianco	Clear Trasparente	21812 0027	21812 0030	365,00
	Silk White Bianco Seta	21812 1327	21812 1330	495,00
	Rainbow Iridescente	21812 0127	21812 0130	595,00
	Glossy Smoke Fumo Lucido	21812 4327	21812 4330	495,00
	Azure Steel Azzurro Metallizzato	21812 8627	21812 8630	495,00

**Light source  
Sorgente luminosa**

**LED**  
2700 K  
7 W  
1280 lm  
350 mA  
CRI 90  
MacAdam 3-Step

LED and driver included  
LED e driver inclusi

**Light source  
Sorgente luminosa**

**LED**  
3000 K  
7 W  
1300 lm  
350 mA  
CRI 90  
MacAdam 3-Step

LED and driver included  
LED e driver inclusi

Net weight 0,69 kg / Peso netto 1,52 lbs  
Pack Colli 2  
Energy class Classe energetica D

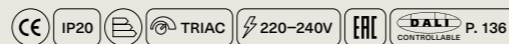

The lamps must be installed on canopies ▶ p. 060-067 or on the DOUBLEZERO7 System ▶ p. 102-123  
Le lampade devono essere installate su rosioni ▶ p. 060-067 o su sistema DOUBLEZERO7 ▶ p. 102-123

Oblò large

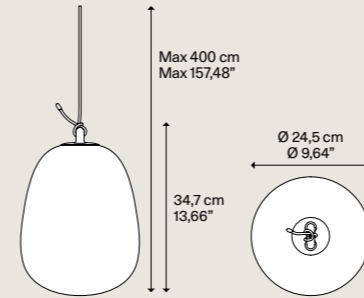

Silicone hook Gancio in silicone	Blown glass diffuser Diffusore in vetro soffiato	Code Codice	Code Codice	Euro €
White Bianco	Clear Trasparente	21813 0027	21813 0030	420,00
	Silk White Bianco Seta	21813 1327	21813 1330	560,00
	Rainbow Iridescente	21813 0127	21813 0130	690,00
	Glossy Smoke Fumo Lucido	21813 4327	21813 4330	560,00
	Azure Steel Azzurro Metallizzato	21813 8627	21813 8630	560,00

**Light source  
Sorgente luminosa**

**LED**  
2700 K  
7 W  
1280 lm  
350 mA  
CRI 90  
MacAdam 3-Step

LED and driver included  
LED e driver inclusi

**Light source  
Sorgente luminosa**

**LED**  
3000 K  
7 W  
1300 lm  
350 mA  
CRI 90  
MacAdam 3-Step

LED and driver included  
LED e driver inclusi

Net weight 0,82 kg / Peso netto 1,80 lbs  
Pack Colli 2  
Energy class Classe energetica D



The lamps must be installed on canopies ▶ p. 060-067 or on the DOUBLEZERO7 System ▶ p. 102-123  
Le lampade devono essere installate su rosioni ▶ p. 060-067 o su sistema DOUBLEZERO7 ▶ p. 102-123

Rain

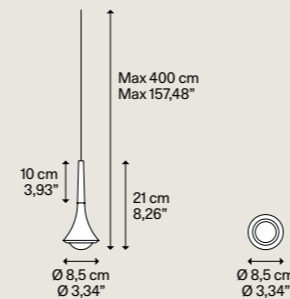

**Light source  
Sorgente luminosa**

**LED**  
2700 K  
7 W  
1280 lm  
350 mA  
CRI 90  
MacAdam 3-Step

LED and driver included  
LED e driver inclusi

**Light source  
Sorgente luminosa**

**LED**  
3000 K  
7 W  
1300 lm  
350 mA  
CRI 90  
MacAdam 3-Step

LED and driver included  
LED e driver inclusi

Net weight 0,34 kg / Peso netto 0,75 lbs  
Pack Colli 2  
Energy class Classe energetica C

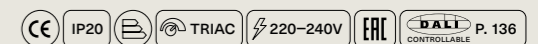

The lamps must be installed on canopies ▶ p. 060-067 or on the DOUBLEZERO7 System ▶ p. 102-123  
Le lampade devono essere installate su rosioni ▶ p. 060-067 o su sistema DOUBLEZERO7 ▶ p. 102-123

Metal structure Montatura in metallo	Metal decor Decoro in metallo	Code Codice	Code Codice	Euro €
Chrome Cromo	Matte Black -9005 Nero Opaco-9005	15611 2027	15611 2030	184,00
	Matte Champagne NEW Champagne Opaco	15611 4527	15611 4530	199,00
Transparent cable Cavo trasparente	Brushed Chrome Cromo Spazzolato	15611 4727	15611 4730	199,00
	Natural Brown *NEW Testa di Moro	15611 6927	15611 6930	199,00
Matte Black -9005 Nero Opaco-9005	Matte Black -9005 Nero Opaco-9005	15612 2027	15612 2030	184,00
	Matte Champagne NEW Champagne Opaco	15612 4527	15612 4530	199,00
Black cable Cavo nero	Brushed Chrome Cromo Spazzolato	15612 4727	15612 4730	199,00
	Natural Brown *NEW Testa di Moro	15612 6927	15612 6930	199,00
Matte Champagne NEW Champagne Opaco	Matte Black -9005 Nero Opaco-9005	15613 2027	15613 2030	184,00
	Matte Champagne NEW Champagne Opaco	15613 4527	15613 4530	199,00
Black cable Cavo nero	Brushed Chrome Cromo Spazzolato	15613 4727	15613 4730	199,00
	Natural Brown *NEW Testa di Moro	15613 6927	15613 6930	199,00

\* NCSS 8005-Y50R

Random

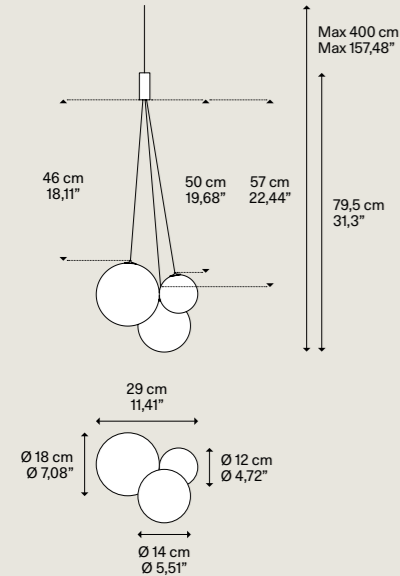

Blown glass diffuser  
Diffusore in vetro soffiato

- Clear  
Trasparente
- Frosted White  
Bianco Satinato
- Glossy Smoke  
Fumo Lucido
- Pale Gold **NEW**  
Oro Chiaro
- Glossy Bronze  
Bronzo Lucido
- Mandarin Orange **NEW**  
Arancio Vivace
- Golden Sage **NEW**  
Salvia Dorata
- Deep Azure Steel **NEW**  
Azzurro Met. Intenso

Structure and cable  
Struttura e cavo

- Chrome  
Cromo
- Silicone/Silicone
- White Translucent  
Bianco translucido
- White cable  
Cavo Bianco
- Matte Black-9005  
Nero Opaco-9005 **NEW**
- Silicone/Silicone
- Matte Black  
Nero Opaco **NEW**
- Black cable  
Cavo Nero

Code Codice	Code Codice	Euro €
16410 0027	16410 0030	266,00
16410 1327	16410 1330	378,00
16410 4327	16410 4330	378,00
16410 4527	16410 4530	378,00
16410 4627	16410 4630	378,00
16410 5827	16410 5830	378,00
16410 7127	16410 7130	378,00
16410 8627	16410 8630	378,00
16411 0027	16411 0030	266,00
16411 1327	16411 1330	378,00
16411 4327	16411 4330	378,00
16411 4527	16411 4530	378,00
16411 4627	16411 4630	378,00
16411 5827	16411 5830	378,00
16411 7127	16411 7130	378,00
16411 8627	16411 8630	378,00

Light source  
Sorgente luminosa

LED  
2700 K  
3x 1 W  
450 lm  
350 mA  
CRI 90  
MacAdam 3-Step  
LED and driver included  
LED e driver inclusi

Light source  
Sorgente luminosa

LED  
3000 K  
3x 1 W  
480 lm  
350 mA  
CRI 90  
MacAdam 3-Step  
LED and driver included  
LED e driver inclusi

Net weight 0,88 kg / 1,94 lbs  
Pack Colli 2  
Energy class Classe energetica D

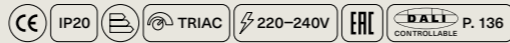

The lamps must be installed on canopies ▶ P. 060-067 or on the DOUBLEZERO7 System ▶ P. 102-123  
Le lampade devono essere installate su rosoni ▶ P. 060-067 o su sistema DOUBLEZERO7 ▶ P. 102-123

Random Five

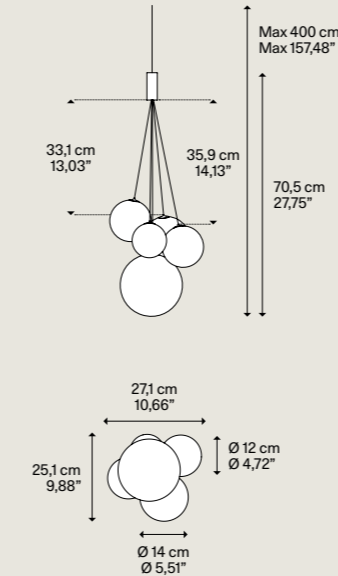

Blown glass diffuser  
Diffusore in vetro soffiato

- Clear  
Trasparente
- Frosted White  
Bianco Satinato
- Glossy Smoke  
Fumo Lucido
- Pale Gold **NEW**  
Oro Chiaro
- Glossy Bronze  
Bronzo Lucido
- Mandarin Orange **NEW**  
Arancio Vivace
- Golden Sage **NEW**  
Salvia Dorata
- Deep Azure Steel **NEW**  
Azzurro Met. Intenso

Structure and cable  
Struttura e cavo

- Chrome  
Cromo
- Silicone/Silicone
- White Translucent  
Bianco translucido
- White cable  
Cavo Bianco
- Matte Black-9005  
Nero Opaco-9005 **NEW**
- Silicone/Silicone
- Matte Black  
Nero Opaco **NEW**
- Black cable  
Cavo Nero

Code Codice	Code Codice	Euro €
16412 0027	16412 0030	350,00
16412 1327	16412 1330	510,00
16412 4327	16412 4330	510,00
16412 4527	16412 4530	510,00
16412 4627	16412 4630	510,00
16412 5827	16412 5830	510,00
16412 7127	16412 7130	510,00
16412 8627	16412 8630	510,00
16413 0027	16413 0030	350,00
16413 1327	16413 1330	510,00
16413 4327	16413 4330	510,00
16413 4527	16413 4530	510,00
16413 4627	16413 4630	510,00
16413 5827	16413 5830	510,00
16413 7127	16413 7130	510,00
16413 8627	16413 8630	510,00

Light source  
Sorgente luminosa

LED  
2700 K  
5x 1 W  
750 lm  
220-240 V  
CRI 90  
MacAdam 3-Step  
LED and driver included  
LED e driver inclusi

Light source  
Sorgente luminosa

LED  
3000 K  
5x 1 W  
800 lm  
220-240 V  
CRI 90  
MacAdam 3-Step  
LED and driver included  
LED e driver inclusi

Net weight 1,058 kg / 2,332 lbs  
Pack Colli 4  
Energy class Classe energetica D

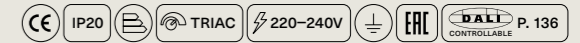

The lamps must be installed on canopies ▶ P. 060-067 or on the DOUBLEZERO7 System ▶ P. 102-123  
Le lampade devono essere installate su rosoni ▶ P. 060-067 o su sistema DOUBLEZERO7 ▶ P. 102-123

Random Solo 10

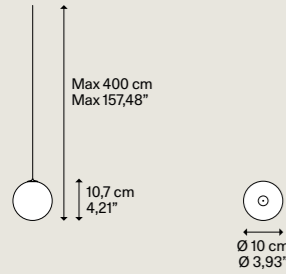

Blown glass diffuser Diffusore in vetro soffiato	Structure and cable Struttura e cavo	Code Codice	<b>A</b> Code Codice	<b>B</b> Code Codice	Euro €
Clear Trasparente		17110 0027	17110 0030		100,00
Frosted White Bianco Satinato		17110 1327	17110 1330		123,00
Glossy Smoke Fumo Lucido		17110 4327	17110 4330		123,00
Pale Gold <b>NEW</b> Oro Chiaro	Silicone/Silicone	17110 4527	17110 4530		123,00
Glossy Bronze Bronzo Lucido	White Translucent Bianco traslucido	17110 4627	17110 4630		123,00
Mandarin Orange <b>NEW</b> Arancio Vivace		17110 5827	17110 5830		123,00
Golden Sage <b>NEW</b> Salvia Dorata		17110 7127	17110 7130		123,00
Deep Azure Steel <b>NEW</b> Azzurro Met. Intenso	White cable Cavo Bianco	17110 8627	17110 8630		123,00
Clear Trasparente		17120 0027	17120 0030		100,00
Frosted White Bianco Satinato		17120 1327	17120 1330		123,00
Glossy Smoke Fumo Lucido		17120 4327	17120 4330		123,00
Pale Gold <b>NEW</b> Oro Chiaro	Silicone/Silicone	17120 4527	17120 4530		123,00
Glossy Bronze Bronzo Lucido	Matte Black Nero Opaco <b>NEW</b>	17120 4627	17120 4630		123,00
Mandarin Orange <b>NEW</b> Arancio Vivace		17120 5827	17120 5830		123,00
Golden Sage <b>NEW</b> Salvia Dorata		17120 7127	17120 7130		123,00
Deep Azure Steel <b>NEW</b> Azzurro Met. Intenso	Black cable Cavo Nero	17120 8627	17120 8630		123,00

Light source Sorgente luminosa	<b>A</b>	Light source Sorgente luminosa	<b>B</b>
LED 2700 1 150 350 CRI 90 MacAdam 3-Step	K W lm mA	LED 3000 1 160 350 CRI 90 MacAdam 3-Step	K W lm mA
LED and driver included LED e driver inclusi		LED and driver included LED e driver inclusi	

Net weight 0,165 kg / Peso netto 0,363 lbs | Pack Colli 2 | Energy class Classe energetica D



The lamps must be installed on canopies ▶ p. 060-067 or on the DOUBLEZERO7 System ▶ p. 102-123  
Le lampade devono essere installate su rosoni ▶ p. 060-067 o su sistema DOUBLEZERO7 ▶ p. 102-123

Random Solo 12

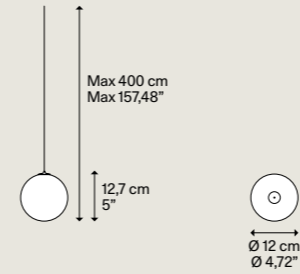

Blown glass diffuser Diffusore in vetro soffiato	Structure and cable Struttura e cavo	Code Codice	<b>A</b> Code Codice	<b>B</b> Code Codice	Euro €
Clear Trasparente		17111 0027	17111 0030		123,00
Frosted White Bianco Satinato		17111 1327	17111 1330		148,00
Glossy Smoke Fumo Lucido		17111 4327	17111 4330		148,00
Pale Gold <b>NEW</b> Oro Chiaro	Silicone/Silicone	17111 4527	17111 4530		148,00
Glossy Bronze Bronzo Lucido	White Translucent Bianco traslucido	17111 4627	17111 4630		148,00
Mandarin Orange <b>NEW</b> Arancio Vivace		17111 5827	17111 5830		148,00
Golden Sage <b>NEW</b> Salvia Dorata		17111 7127	17111 7130		148,00
Deep Azure Steel <b>NEW</b> Azzurro Met. Intenso	White cable Cavo Bianco	17111 8627	17111 8630		148,00
Clear Trasparente		17121 0027	17121 0030		123,00
Frosted White Bianco Satinato		17121 1327	17121 1330		148,00
Glossy Smoke Fumo Lucido		17121 4327	17121 4330		148,00
Pale Gold <b>NEW</b> Oro Chiaro	Silicone/Silicone	17121 4527	17121 4530		148,00
Glossy Bronze Bronzo Lucido	Matte Black Nero Opaco <b>NEW</b>	17121 4627	17121 4630		148,00
Mandarin Orange <b>NEW</b> Arancio Vivace		17121 5827	17121 5830		148,00
Golden Sage <b>NEW</b> Salvia Dorata		17121 7127	17121 7130		148,00
Deep Azure Steel <b>NEW</b> Azzurro Met. Intenso	Black cable Cavo Nero	17121 8627	17121 8630		148,00

Light source Sorgente luminosa	<b>A</b>	Light source Sorgente luminosa	<b>B</b>
LED 2700 1 150 350 CRI 90 MacAdam 3-Step	K W lm mA	LED 3000 1 160 350 CRI 90 MacAdam 3-Step	K W lm mA
LED and driver included LED e driver inclusi		LED and driver included LED e driver inclusi	

Net weight 0,20 kg / Peso netto 0,44 lbs | Pack Colli 2 | Energy class Classe energetica D



The lamps must be installed on canopies ▶ p. 060-067 or on the DOUBLEZERO7 System ▶ p. 102-123  
Le lampade devono essere installate su rosoni ▶ p. 060-067 o su sistema DOUBLEZERO7 ▶ p. 102-123

Random Solo 14

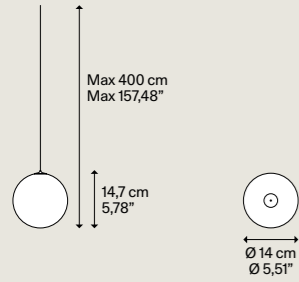

Blown glass diffuser  
Diffusore in vetro soffiato

- Clear  
Trasparente
- Frosted White  
Bianco Satinato
- Glossy Smoke  
Fumo Lucido
- Pale Gold NEW  
Oro Chiaro
- Glossy Bronze  
Bronzo Lucido
- Mandarin Orange NEW  
Arancio Vivace
- Golden Sage NEW  
Salvia Dorata
- Deep Azure Steel NEW  
Azzurro Met. Intenso

Structure and cable  
Struttura e cavo

- White Translucent  
Bianco traslucido
- White cable  
Cavo Bianco

- Clear  
Trasparente
- Frosted White  
Bianco Satinato
- Glossy Smoke  
Fumo Lucido
- Pale Gold NEW  
Oro Chiaro
- Glossy Bronze  
Bronzo Lucido
- Mandarin Orange NEW  
Arancio Vivace
- Golden Sage NEW  
Salvia Dorata
- Deep Azure Steel NEW  
Azzurro Met. Intenso

- Matte Black  
Nero Opaco NEW
- Black cable  
Cavo Nero

Light source  
Sorgente luminosa **A**

LED  
2700 K  
1 W  
150 lm  
350 mA  
CRI 90  
MacAdam 3-Step

LED and driver included  
LED e driver inclusi

Light source  
Sorgente luminosa **B**

LED  
3000 K  
1 W  
160 lm  
350 mA  
CRI 90  
MacAdam 3-Step

LED and driver included  
LED e driver inclusi

Code Codice <b>A</b>	Code Codice <b>B</b>	VAT excluded IVA esclusa Euro €
17112 0027	17112 0030	128,00
17112 1327	17112 1330	159,00
17112 4327	17112 4330	159,00
17112 4527	17112 4530	159,00
17112 4627	17112 4630	159,00
17112 5827	17112 5830	159,00
17112 7127	17112 7130	159,00
17112 8627	17112 8630	159,00
17122 0027	17122 0030	128,00
17122 1327	17122 1330	159,00
17122 4327	17122 4330	159,00
17122 4527	17122 4530	159,00
17122 4627	17122 4630	159,00
17122 5827	17122 5830	159,00
17122 7127	17122 7130	159,00
17122 8627	17122 8630	159,00

Net weight 0,22 kg / 0,48 lbs  
Pack Colli 2  
Energy class Classe energetica D

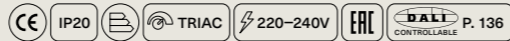

The lamps must be installed on canopies ▶ p. 060-067 or on the DOUBLEZERO7 System ▶ p. 102-123  
Le lampade devono essere installate su rosoni ▶ p. 060-067 o su sistema DOUBLEZERO7 ▶ p. 102-123

Random Solo 18

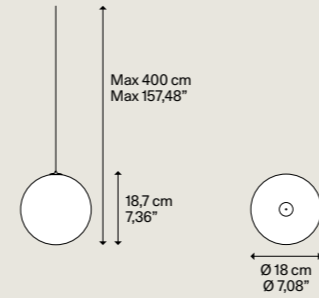

Blown glass diffuser  
Diffusore in vetro soffiato

- Clear  
Trasparente
- Frosted White  
Bianco Satinato
- Glossy Smoke  
Fumo Lucido
- Pale Gold NEW  
Oro Chiaro
- Glossy Bronze  
Bronzo Lucido
- Mandarin Orange NEW  
Arancio Vivace
- Golden Sage NEW  
Salvia Dorata
- Deep Azure Steel NEW  
Azzurro Met. Intenso

Structure and cable  
Struttura e cavo

- White Translucent  
Bianco traslucido
- White cable  
Cavo Bianco

- Clear  
Trasparente
- Frosted White  
Bianco Satinato
- Glossy Smoke  
Fumo Lucido
- Pale Gold NEW  
Oro Chiaro
- Glossy Bronze  
Bronzo Lucido
- Mandarin Orange NEW  
Arancio Vivace
- Golden Sage NEW  
Salvia Dorata
- Deep Azure Steel NEW  
Azzurro Met. Intenso

- Matte Black  
Nero Opaco NEW
- Black cable  
Cavo Nero

Light source  
Sorgente luminosa **A**

LED  
2700 K  
1 W  
150 lm  
350 mA  
CRI 90  
MacAdam 3-Step

LED and driver included  
LED e driver inclusi

Light source  
Sorgente luminosa **B**

LED  
3000 K  
1 W  
160 lm  
350 mA  
CRI 90  
MacAdam 3-Step

LED and driver included  
LED e driver inclusi

Net weight 0,35 kg / 0,77 lbs  
Pack Colli 2  
Energy class Classe energetica D

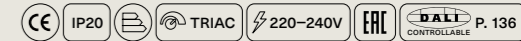

The lamps must be installed on canopies ▶ p. 060-067 or on the DOUBLEZERO7 System ▶ p. 102-123  
Le lampade devono essere installate su rosoni ▶ p. 060-067 o su sistema DOUBLEZERO7 ▶ p. 102-123

Random Solo 23

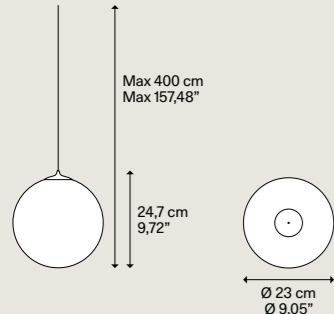

Blown glass diffuser  
Diffusore in vetro soffiato

- Clear  
Trasparente
- Frosted White  
Bianco Satinato
- Glossy Smoke  
Fumo Lucido
- Pale Gold **NEW**  
Oro Chiaro
- Glossy Bronze  
Bronzo Lucido
- Mandarin Orange **NEW**  
Arancio Vivace
- Golden Sage **NEW**  
Salvia Dorata
- Deep Azure Steel **NEW**  
Azzurro Met. Intenso

Structure and cable  
Struttura e cavo

White Translucent  
Bianco traslucido

White cable  
Cavo Bianco

Matte Black  
Nero Opaco **NEW**

Black cable  
Cavo Nero

Code **A** Code **B** Euro €  
Codice A Codice B Euro €

17114 0027	17114 0030	235,00
17114 1327	17114 1330	357,00
17114 4327	17114 4330	357,00
17114 4527	17114 4530	357,00
17114 4627	17114 4630	357,00
17114 5827	17114 5830	357,00
17114 7127	17114 7130	357,00
17114 8627	17114 8630	357,00
17124 0027	17124 0030	235,00
17124 1327	17124 1330	357,00
17124 4327	17124 4330	357,00
17124 4527	17124 4530	357,00
17124 4627	17124 4630	357,00
17124 5827	17124 5830	357,00
17124 7127	17124 7130	357,00
17124 8627	17124 8630	357,00

Light source **A**  
Sorgente luminosa

LED  
2700 K  
3 W  
450 lm  
350 mA  
CRI 90  
MacAdam 3-Step

LED and driver included  
LED e driver inclusi

Light source **B**  
Sorgente luminosa

LED  
3000 K  
3 W  
480 lm  
350 mA  
CRI 90  
MacAdam 3-Step

LED and driver included  
LED e driver inclusi

Net weight 0,60 kg / 1,32 lbs  
Pack Colli 2  
Energy class Classe energetica D



The lamps must be installed on canopies ▶ p. 060-067 or on the DOUBLEZERO7 System ▶ p. 102-123  
Le lampade devono essere installate su rosoni ▶ p. 060-067 o su sistema DOUBLEZERO7 ▶ p. 102-123

Random Solo 28

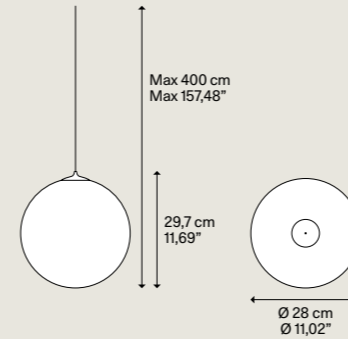

Blown glass diffuser  
Diffusore in vetro soffiato

- Clear  
Trasparente
- Frosted White  
Bianco Satinato
- Glossy Smoke  
Fumo Lucido
- Pale Gold **NEW**  
Oro Chiaro
- Glossy Bronze  
Bronzo Lucido
- Mandarin Orange **NEW**  
Arancio Vivace
- Golden Sage **NEW**  
Salvia Dorata
- Deep Azure Steel **NEW**  
Azzurro Met. Intenso

Structure and cable  
Struttura e cavo

White Translucent  
Bianco traslucido

White cable  
Cavo Bianco

Matte Black  
Nero Opaco **NEW**

Black cable  
Cavo Nero

Light source **A**  
Sorgente luminosa

LED  
2700 K  
3 W  
450 lm  
350 mA  
CRI 90  
MacAdam 3-Step

LED and driver included  
LED e driver inclusi

Light source **B**  
Sorgente luminosa

LED  
3000 K  
3 W  
480 lm  
350 mA  
CRI 90  
MacAdam 3-Step

LED and driver included  
LED e driver inclusi

Net weight 0,90 kg / 1,98 lbs  
Pack Colli 2  
Energy class Classe energetica D



The lamps must be installed on canopies ▶ p. 060-067 or on the DOUBLEZERO7 System ▶ p. 102-123  
Le lampade devono essere installate su rosoni ▶ p. 060-067 o su sistema DOUBLEZERO7 ▶ p. 102-123

# Spider

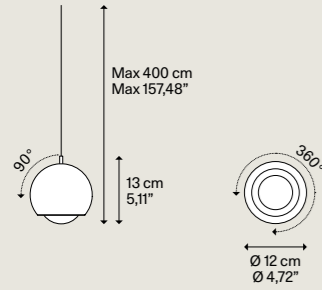

Metal structure Montatura in metallo	Metal diffuser Diffusore in metallo	Code Codice	Code Codice	Euro €
Chrome Cromo	Matte White-9010 Bianco Opaco-9010	16010 1027	16010 1030	255,00
	Matte Black-9005 Nero Opaco-9005	16010 2027	16010 2030	255,00
	Extra Matte Champagne Champagne Extra Opaco	16010 4527	16010 4530	270,00
	Extra Matte Terra Terra Extra Opaco	16010 6727	16010 6730	280,00

Adjustable light  
Luce orientabile

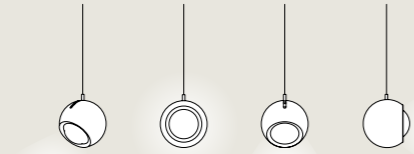

Light source Sorgente luminosa		Light source Sorgente luminosa	
A		B	
LED	K	LED	K
2700	11	3000	11
11	W	1300	W
1280	lm	350	lm
350	mA	350	mA
CRI 90		CRI 90	
MacAdam 3-Step		MacAdam 3-Step	
LED and driver included LED e driver inclusi		LED and driver included LED e driver inclusi	

Net weight Peso netto	0,80 kg 1,76 lbs	Pack Colli	2	Energy class Classe energetica	C
--------------------------	---------------------	---------------	---	-----------------------------------	---

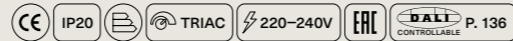

The lamps must be installed on canopies ▶ p. 060-067 or on the DOUBLEZERO7 System ▶ p. 102-123  
Le lampade devono essere installate su rosioni ▶ p. 060-067 o su sistema DOUBLEZERO7 ▶ p. 102-123

# Volum 14

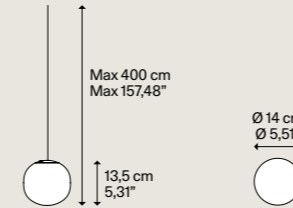

Methacrylate structure Struttura in metacrilato	Blown glass diffuser Diffusore in vetro soffiato	Code Codice	Euro €
Glossy White Bianco Lucido	Glossy White Bianco Lucido	18711 1200	174,00

Light source  
Sorgente luminosa

E14 LED T18 1x 5 W (max 10 W)	Ø max 6 cm Ø max 2,36" W/L max 8 cm W/L max 3,14"
----------------------------------	--

Light bulb to be ordered separately  
Lampadina da ordinare separatamente

Net weight Peso netto	0,90 kg 1,98 lbs	Pack Colli	2
--------------------------	---------------------	---------------	---

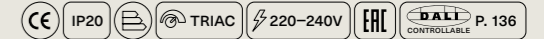

# Volum 22

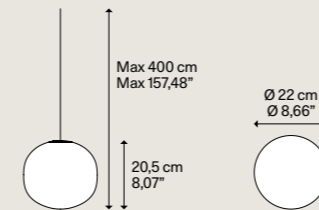

Methacrylate structure Struttura in metacrilato	Blown glass diffuser Diffusore in vetro soffiato	Code Codice	Euro €
Glossy White Bianco Lucido	Glossy White Bianco Lucido	18712 1200	260,00

Light source  
Sorgente luminosa

E27 LED T28 1x 10 W (max 25 W)	Ø max 6 cm Ø max 2,36" W/L max 11 cm W/L max 4,33"
-----------------------------------	---

Light bulb to be ordered separately  
Lampadina da ordinare separatamente

Net weight Peso netto	1,30 kg 2,86 lbs	Pack Colli	2
--------------------------	---------------------	---------------	---

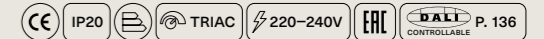

# Volum 29

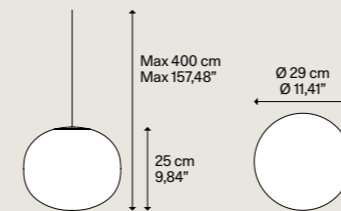

Methacrylate structure Struttura in metacrilato	Blown glass diffuser Diffusore in vetro soffiato	Code Codice	Euro €
Glossy White Bianco Lucido	Glossy White Bianco Lucido	18713 1200	327,00

Light source  
Sorgente luminosa

E27 LED T35 1x 13 W (max 25 W)	Ø max 9,8 cm Ø max 3,74"
-----------------------------------	-----------------------------

Light bulb to be ordered separately  
Lampadina da ordinare separatamente

Net weight Peso netto	2,12 kg 4,67 lbs	Pack Colli	2
--------------------------	---------------------	---------------	---

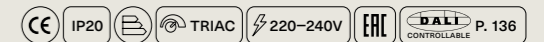

The lamps must be installed on canopies ▶ p. 060-067 or on the DOUBLEZERO7 System ▶ p. 102-123  
Le lampade devono essere installate su rosioni ▶ p. 060-067 o su sistema DOUBLEZERO7 ▶ p. 102-123

Light source Sorgente luminosa	Bulb dimension Dimensione lampadina	Lamp Lampada	Pack Colli	Code Codice	Euro €
E14 LED T18 5 W	2700 K 500 lm CRI 90 MacAdam 3-Step	Ø 1,8 cm Ø 0,70"	1	LAM-0017	25,00
E27 LED T28 10 W	2700 K 1000 lm CRI 90 MacAdam 3-Step	Ø 2,8 cm Ø 1,10"	1	LAM-0014	30,00
E27 LED T35 13 W	2700 K 1500 lm CRI 90 MacAdam 3-Step	Ø 3,5 cm Ø 1,37"	1	LAM-0015	40,00

Dimmable bulbs / Lampadine dimmerabili

# Single canopies

## CATEGORY RECESSED CANOPY

### Recessed Micro

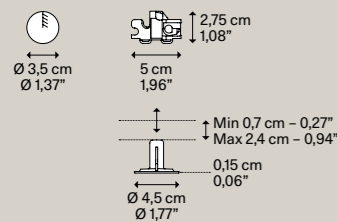

Net weight 0,015 kg / 0,033 lbs  
Pack Colli 1

Description Descrizione	Methacrylate structure Struttura in metacrilato	Installation Installazione	Code Codice	Euro €	VAT excluded IVA esclusa
Recessed canopy for single pendant, with a maximum load capacity of 3,5 kg - 7,71 lbs. Suitable for false ceilings up to 2,4 cm - 0,94" thick.  Rosone da incasso per lampada singola, con portata massima di 3,5 kg - 7,71 lbs. Adatto a controsoffitti con spessore fino a 2,4 cm - 0,94".	Matte White - 9010* Bianco Opaco - 9010*	Recessed	R01L01 1000	26,00	
	Matte Black - 9005 Nero Opaco - 9005		R01L01 2000	26,00	
	Chrome Cromo		R01L01 4000	31,00	



CE IP20

### Recessed Micro Trimless

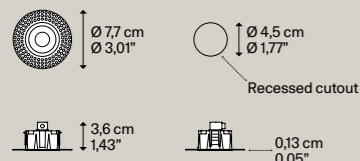

Net weight 0,12 kg / 0,26 lbs  
Pack Colli 1

Description Descrizione	Methacrylate structure Struttura in metacrilato	Installation Installazione	Code Codice	Euro €	VAT excluded IVA esclusa
Trimless recessed canopy for a single pendant available in Pure and Deep versions, with a maximum load capacity of 3,5 kg - 7,71 lbs. Suitable for false ceilings up to 2,2 cm - 0,85" thick.  Rosone da incasso trimless in versione Pure e Deep per lampada singola, con portata massima di 3,5 kg - 7,71 lbs. Adatto a controsoffitti con spessore fino a 2,2 cm - 0,85".	Matte White - 9010* Bianco Opaco - 9010*	Recessed	R13L01 1000	28,00	
	Matte Black - 9005 Nero Opaco - 9005		R13L01 2000	28,00	

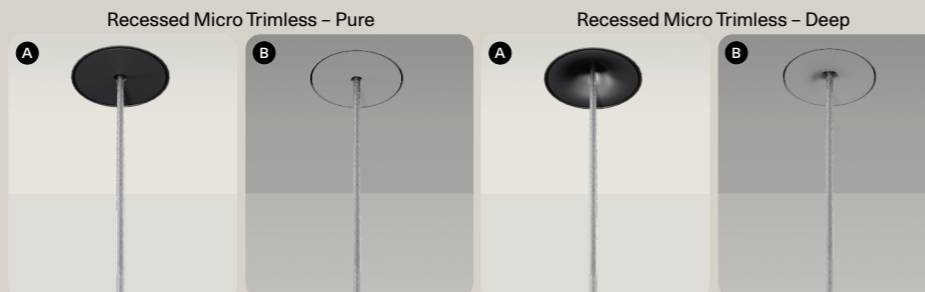

A Recessed Micro Trimless - Not painted  
B Recessed Micro Trimless - Painted

CE IP20

## CATEGORY SINGLE CANOPY

### Single Mini



Net weight 0,13 kg / 0,28 lbs  
Pack Colli 1

Description Descrizione	Methacrylate structure Struttura in metacrilato	Installation Installazione	Code Codice	Euro €	VAT excluded IVA esclusa
Surface-mounted canopy for a single pendant, with a maximum load capacity of 3,5 kg - 7,71 lbs.  Rosone a superficie per lampada singola, con portata massima di 3,5 kg - 7,71 lbs.	Matte White - 9010 Bianco Opaco - 9010	Single	R11L01 1000	43,00	
	Matte Black - 9005 Nero Opaco - 9005		R11L01 2000	43,00	
	Chrome Cromo		R11L01 4000	60,00	
	Matte Champagne Champagne Opaco		R11L01 4500	49,00	
	Natural Brown** Testa di Moro		R11L01 6900	49,00	

\*\* NCS S 8005-Y50R



CE IP20

## CATEGORY WALL CANOPY NEW

### Wall Oval

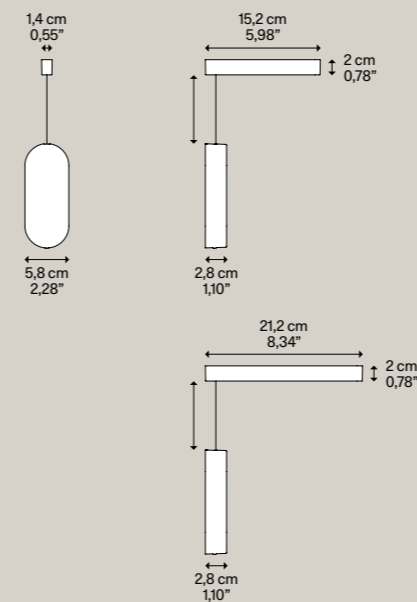

Net weight 0,50 kg / 1,10 lbs  
Pack Colli 1

Description Descrizione	Metal structure Montatura in metallo	Installation Installazione	Code Codice	Euro €	VAT excluded IVA esclusa
Wall canopy for a single pendant, with a maximum load capacity of 3,5 kg - 7,71 lbs. Includes two upper elements in different sizes, adjustable in distance from the oval base.  Rosone da parete per lampada singola, con portata massima di 3,5 kg - 7,71 lbs. Include due elementi superiori di diverse dimensioni, regolabili in distanza rispetto alla base ovale.	Matte White - 9010 Bianco Opaco - 9010	Wall	R17L01 1000	99,00	
	Matte Black - 9005 Nero Opaco - 9005		R17L01 2000	99,00	
	Matte Champagne Champagne Opaco		R17L01 4500	105,00	
	Natural Brown** Testa di Moro		R17L01 6900	105,00	

\*\* NCS S 8005-Y50R



CE IP20

# Multiple canopies

CATEGORY CLUSTER CANOPY **NEW**

## 5 Lights Round small

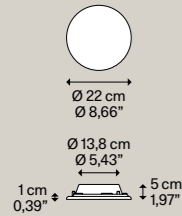

### Description

Round small canopy for up to 5 suspensions arranged along the perimeter.

Rosone Round small per un massimo di 5 sospensioni disposte lungo il perimetro.

### Metal structure

● Matte White - 9010  
Bianco Opaco - 9010

● Matte Black - 9005  
Nero Opaco - 9005

### System

Cluster

### Code

R15L05 1000

R15L05 2000

### Euro €

220,00

220,00

VAT excluded  
IVA esclusa

Net weight 1,18 kg  
Peso netto 2,60 lbs

Pack Colli 1

CE IP20

**NEW**

## 5 Lights Round large

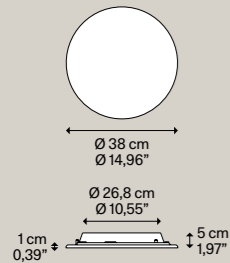

### Description

Round large canopy for up to 5 suspensions arranged along the perimeter.

Rosone Round large per un massimo di 5 sospensioni disposte lungo il perimetro.

### Metal structure

● Matte White - 9010  
Bianco Opaco - 9010

● Matte Black - 9005  
Nero Opaco - 9005

### System

Cluster

### Code

R16L05 1000

R16L05 2000

### Euro €

320,00

320,00

VAT excluded  
IVA esclusa

Net weight 2,67 kg  
Peso netto 5,88 lbs

Pack Colli 1

CE IP20

CATEGORY CLUSTER CANOPY **NEW**

## 9 Lights Round small

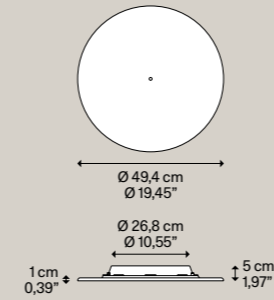

Net weight 3,90 kg  
Peso netto 8,59 lbs

Pack Colli 1

**NEW**

## 9 Lights Round large

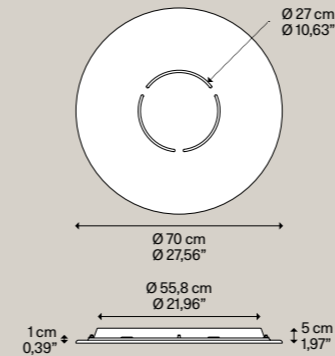

Net weight 8,50 kg  
Peso netto 18,73 lbs

Pack Colli 1

### Description

Round small canopy for up to 9 suspensions: 1 in the center and 8 arranged around the perimeter.

Rosone Round small per un massimo di 9 sospensioni: 1 centrale e 8 disposte lungo il perimetro.

### Metal structure

● Matte White - 9010  
Bianco Opaco - 9010

● Matte Black - 9005  
Nero Opaco - 9005

### System

Cluster

### Code

R15L09 1000

R15L09 2000

### Euro €

390,00

390,00

VAT excluded  
IVA esclusa

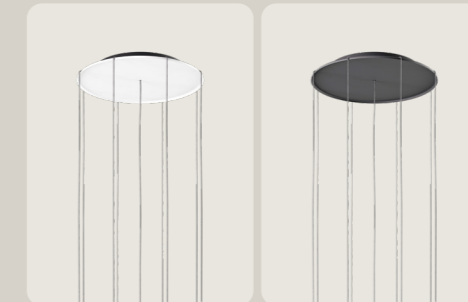

Possible suspension lamps configurations

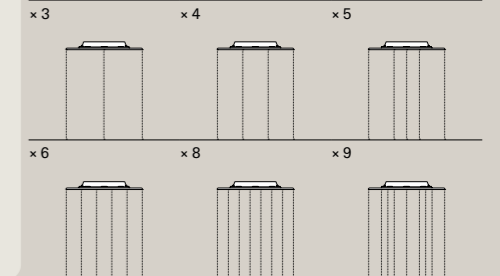

CE IP20

### Description

Round large canopy for up to 9 suspensions: 3 in the center and 6 arranged around the perimeter.

Rosone Round large per un massimo di 9 sospensioni: 3 centrali e 6 disposte lungo il perimetro.

### Metal structure

● Matte White - 9010  
Bianco Opaco - 9010

● Matte Black - 9005  
Nero Opaco - 9005

### System

Cluster

### Code

R16L09 1000

R16L09 2000

### Euro €

560,00

560,00

VAT excluded  
IVA esclusa

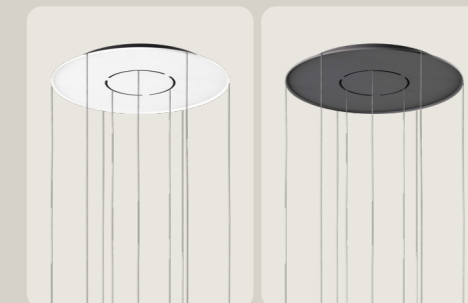

Possible suspension lamps configurations

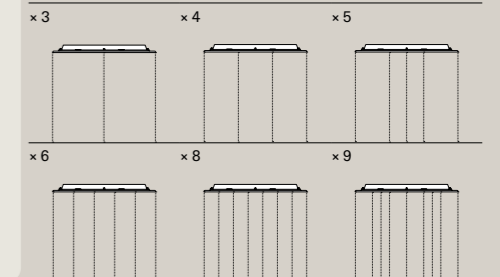

CE IP20

### Canopy

Rosone

5 Lights Round small

5 Lights Round large

9 Lights Round small

9 Lights Round large

### Suspension aligned

Sospensione allineata

A max Ø 120 mm

B max Ø 210 mm

C max Ø 180 mm

D max Ø 220 mm

### Staggered suspension

Sospensione sfalsata

A max Ø 250 mm

B max Ø 430 mm

C max Ø 430 mm

D max Ø 430 mm

### Disposition

Disposizione

A

B

C

D

### 14 Lights Round

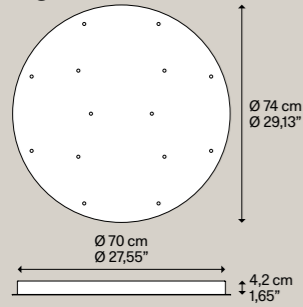

Net weight 14,14 kg / 31,17 lbs  
Pack Colli 1

Description Descrizione	Metal structure Struttura in metallo	System Sistema	Code Codice	Euro €
Round canopy for 14 suspensions. Rosone circolare per 14 sospensioni.	Matte White - 9010 Bianco Opaco - 9010	Cluster	R04L14 1000	1.060,00
	Matte Black - 9005 Nero Opaco - 9005		R04L14 2000	1.060,00

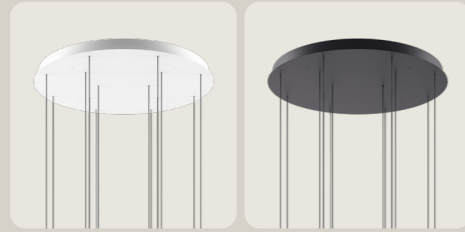

CE IP20

### 24 Lights Round

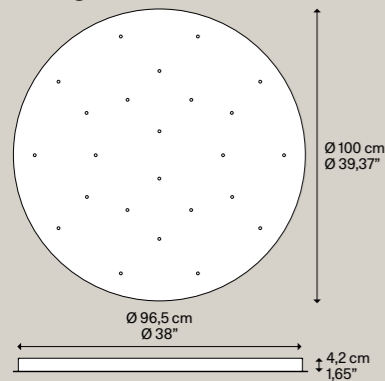

Net weight 23,50 kg / 51,80 lbs  
Pack Colli 1

Description Descrizione	Metal structure Struttura in metallo	System Sistema	Code Codice	Euro €
Round canopy for 24 suspensions. Rosone circolare per 24 sospensioni.	Matte White - 9010 Bianco Opaco - 9010	Cluster	R04L24 1000	1.835,00
	Matte Black - 9005 Nero Opaco - 9005		R04L24 2000	1.835,00

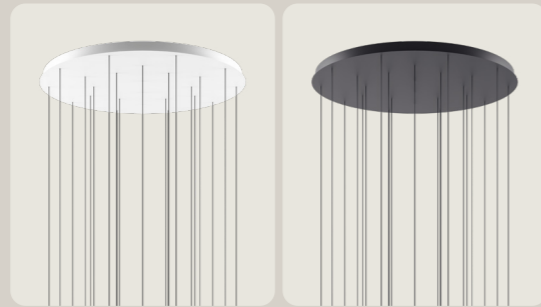

CE IP20

### 36 Lights Round

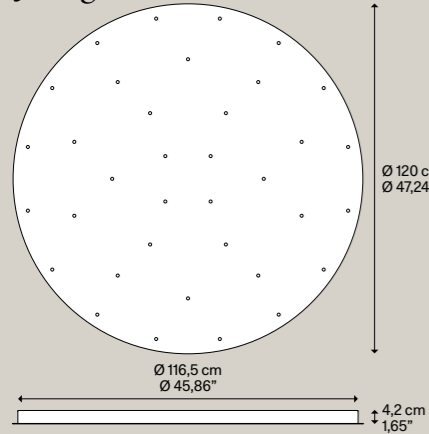

Net weight 32,70 kg / 72,09 lbs  
Pack Colli 1

Description Descrizione	Metal structure Struttura in metallo	System Sistema	Code Codice	Euro €
Round canopy for 36 suspensions. Rosone circolare per 36 sospensioni.	Matte White - 9010 Bianco Opaco - 9010	Cluster	R04L36 1000	2.360,00
	Matte Black - 9005 Nero Opaco - 9005		R04L36 2000	2.360,00

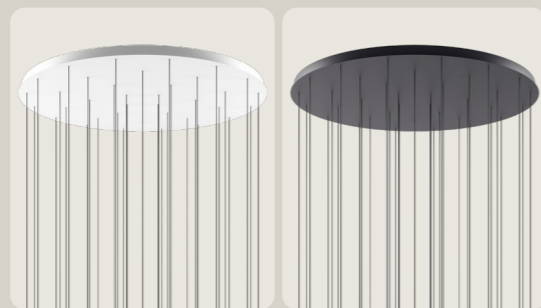

CE IP20

PREVIOUS VERSION	Metal structure Struttura in metallo	3 Lights Round *	5 Lights Round *	7 Lights Round *	9 Lights Round *
System Cluster	Matte White - 9010 Bianco Opaco - 9010	R04L03 1000	R04L05 1000	R04L07 1000	R04L09 1000
	Matte Black - 9005 Nero Opaco - 9005	R04L03 2000	R04L05 2000	R04L07 2000	R04L09 2000

► \* Available while stocks last.

► \* Disponibile fino ad esaurimento scorte.

### 7 Lights Oval

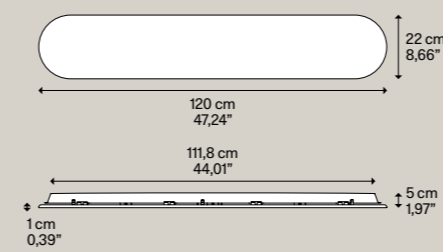

Possible suspension lamps configurations

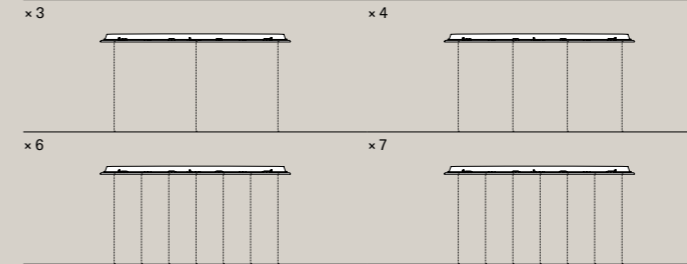

Net weight 6,50 kg / 14,33 lbs  
Pack Colli 1

Description Descrizione	Metal structure Struttura in metallo	System Sistema	Code Codice	Euro €
Oval canopy for up to 7 suspensions arranged along the perimeter. Rosone Oval per un massimo di 7 sospensioni disposte lungo il perimetro.	Matte White - 9010 Bianco Opaco - 9010	Cluster	R14L07 1000	420,00
	Matte Black - 9005 Nero Opaco - 9005		R14L07 2000	420,00



CE IP20

**NEW**

### 11 Lights Oval

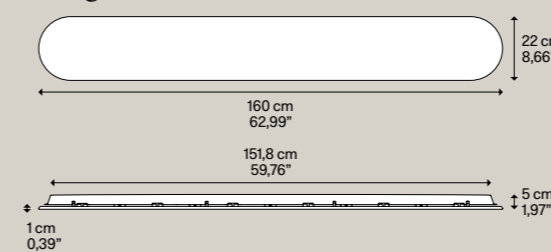

Possible suspension lamps configurations

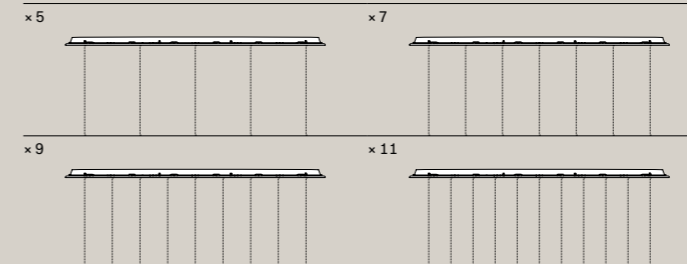

Net weight 8,80 kg / 19,40 lbs  
Pack Colli 1

Description Descrizione	Metal structure Struttura in metallo	System Sistema	Code Codice	Euro €
Oval canopy for up to 11 suspensions arranged along the perimeter. Rosone Oval per un massimo di 11 sospensioni disposte lungo il perimetro.	Matte White - 9010 Bianco Opaco - 9010	Cluster	R14L11 1000	650,00
	Matte Black - 9005 Nero Opaco - 9005		R14L11 2000	650,00

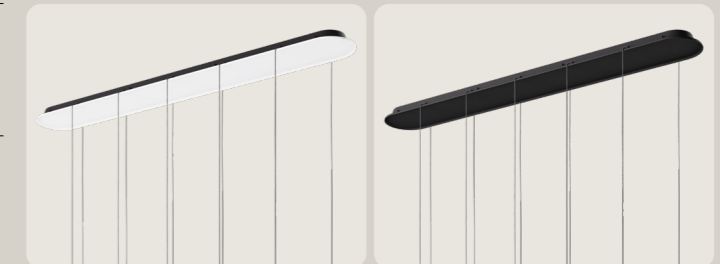

CE IP20

Canopy Rosone	Suspension aligned Sospensione allineata	Staggered suspension Sospensione sfalsata	Disposition Disposizione
7 Lights Oval	<b>A</b> max Ø 255 mm	<b>A</b> max Ø 520 mm	<b>A</b>
11 Lights Oval	<b>B</b> max Ø 245 mm	<b>B</b> max Ø 500 mm	<b>B</b>

PREVIOUS VERSION	Metal structure Struttura in metallo	Short Lights Track *	Long Lights Track *
System Cluster	Matte White - 9010 Bianco Opaco - 9010	R08L07 1000	R08L11 1000
	Matte Black - 9005 Nero Opaco - 9005	R08L07 2000	R08L11 2000

► \* Available while stocks last.

► \* Disponibile fino ad esaurimento scorte.

### 7 Lights Rectangular

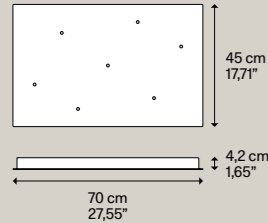

Net weight 9,89 kg / 21,80 lbs  
Pack 1 / Colli 1

Description Descrizione	Metal structure Struttura in metallo	System Sistema	Code Codice	Euro €	VAT excluded IVA esclusa
Rectangular canopy for 7 suspensions.	Matte White - 9010 Bianco Opaco - 9010	Cluster	R05L07 1000	560,00	
Rosone Rectangular per 7 sospensioni.	Matte Black - 9005 Nero Opaco - 9005		R05L07 2000	560,00	

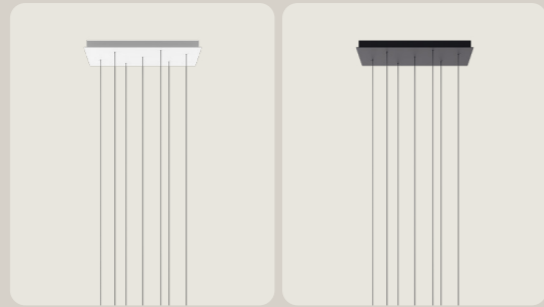

CE IP20

### 14 Lights Rectangular

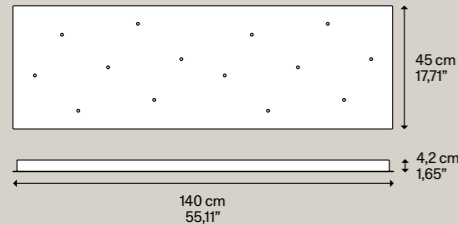

Net weight 17,10 kg / 37,80 lbs  
Pack 1 / Colli 1

Description Descrizione	Metal structure Struttura in metallo	System Sistema	Code Codice	Euro €	VAT excluded IVA esclusa
Rectangular canopy for 14 suspensions.	Matte White - 9010 Bianco Opaco - 9010	Cluster	R05L14 1000	1.005,00	
Rosone Rectangular per 14 sospensioni.	Matte Black - 9005 Nero Opaco - 9005		R05L14 2000	1.005,00	

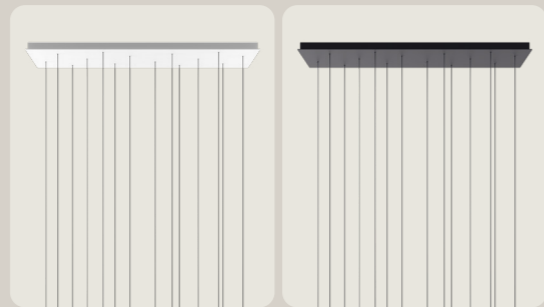

CE IP20

### 28 Lights Rectangular

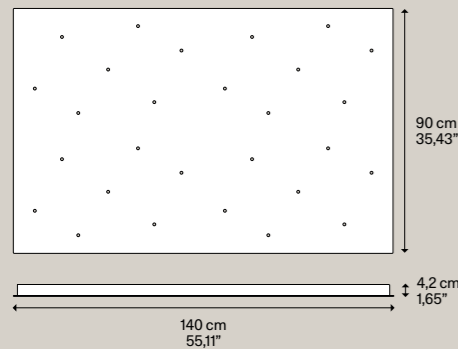

Net weight 31,10 kg / 68,56 lbs  
Pack 1 / Colli 1

Description Descrizione	Metal structure Struttura in metallo	System Sistema	Code Codice	Euro €	VAT excluded IVA esclusa
Rectangular canopy for 28 suspensions.	Matte White - 9010 Bianco Opaco - 9010	Cluster	R05L28 1000	1.785,00	
Rosone Rectangular per 28 sospensioni.	Matte Black - 9005 Nero Opaco - 9005		R05L28 2000	1.785,00	

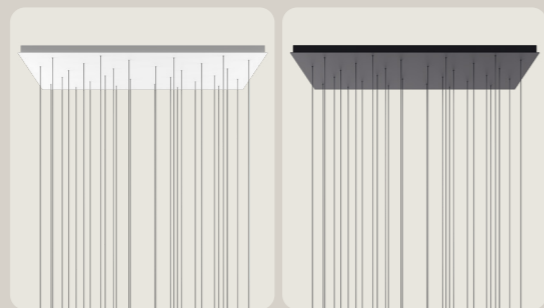

CE IP20

### 4 Lights Radial

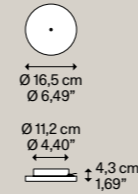

Net weight 0,35 kg / 0,13 lbs  
Pack 1 / Colli 1

Description Descrizione	Metal structure Struttura in metallo	System Sistema	Code Codice	Euro €	VAT excluded IVA esclusa
Radial canopy for up to 4 suspensions. Swag Kit to be ordered separately	Matte White - 9010 Bianco Opaco - 9010	Radial	R10L04 1000	139,00	
Rosone Radial per un massimo di 4 sospensioni. Swag Kit da ordinare separatamente	Matte Black - 9005 Nero Opaco - 9005		R10L04 2000	139,00	

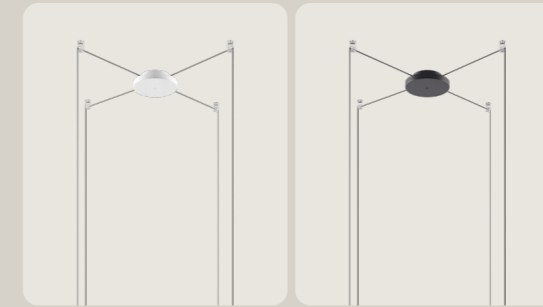

CE IP20

### 12 Lights Radial

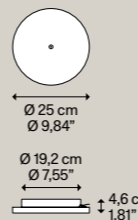

Net weight 1,05 kg / 2,31 lbs  
Pack 1 / Colli 1

Description Descrizione	Metal structure Struttura in metallo	System Sistema	Code Codice	Euro €	VAT excluded IVA esclusa
Radial canopy for up to 12 suspensions. Swag Kit to be ordered separately	Matte White - 9010 Bianco Opaco - 9010	Radial	R10L12 1000	322,00	
Rosone Radial per un massimo di 12 sospensioni. Swag Kit da ordinare separatamente	Matte Black - 9005 Nero Opaco - 9005		R10L12 2000	322,00	

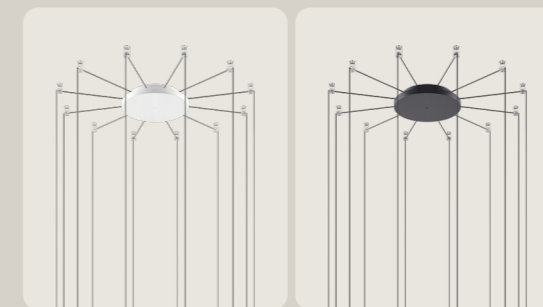

CE IP20

### 28 Lights Radial

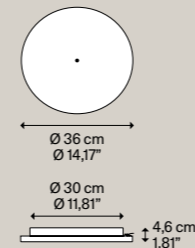

Net weight 3,35 kg / 7,38 lbs  
Pack 1 / Colli 1

Description Descrizione	Metal structure Struttura in metallo	System Sistema	Code Codice	Euro €	VAT excluded IVA esclusa
Radial canopy for up to 28 suspensions. Swag Kit to be ordered separately	Matte White - 9010 Bianco Opaco - 9010	Radial	R10L28 1000	530,00	
Rosone Radial per un massimo di 28 sospensioni. Swag Kit da ordinare separatamente	Matte Black - 9005 Nero Opaco - 9005		R10L28 2000	530,00	

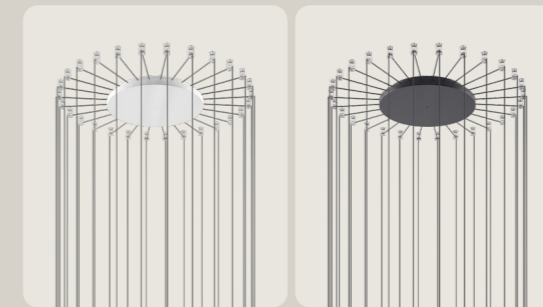

CE IP20

### Swag Kit for Radial Canopy

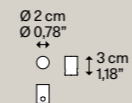

Net weight 0,02 kg / 0,04 lbs  
Pack 1 / Colli 1

Description Descrizione	Polycarbonate structure Struttura in policarbonato	System Sistema	Code Codice	Euro €	VAT excluded IVA esclusa
Offset cylinder for redirecting the cable and adjusting the suspension point. Max Ø 7 mm - 0,27" Max capacity 5 kg - 11,02 lbs	Clear Trasparente	Radial	999A4 00	22,00	
Cilindro di decentramento per fissare il cavo elettrico e regolare il punto di sospensione. Max Ø 7 mm - 0,27" Portata max 5 kg - 11,02 lbs.					

CE

# Wall & Ceiling lamps

## Wall lamps

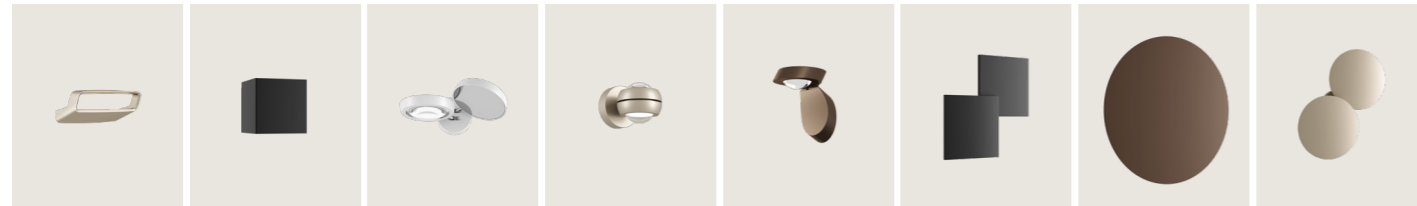

Aile P. 072   Laser P. 074   Nautilus P. 075   Nautilus Mini P. 076   Pin-Up P. 077   Puzzle P. 079   Puzzle Mega P. 080-082   Puzzle Round P. 078, 079



Shift P. 086   Volum P. 087-089

## Ceiling lamps



A-Tube P. 069   A-Tube Nano Swing P. 070, 071   Bugia P. 072-074   Nautilus P. 075   Nautilus Spot P. 077   Pin-Up P. 077   Puzzle P. 079   Puzzle Mega P. 080-082



Puzzle Round P. 078, 079   Spider P. 083   Tidal P. 084, 085   Volum P. 087-089

### CATEGORY CEILING LAMP

DESIGN Studio Italia Design, 2013

VAT excluded  
IVA esclusa

#### A-Tube mini

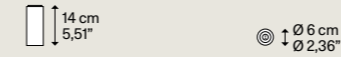

Light source  
Sorgente luminosa

GU10 Par 16  
1x 10 W

W/L max 9 cm  
W/L max 3,54"

Bulb not included  
Lampadina non inclusa

Net weight 0,20 kg  
Peso netto 0,44 lbs   Pack Colli 1

Metal structure  
Montatura in metallo

Matte White - 9010  
Bianco Opaco - 9010

Matte Black - 9005  
Nero Opaco - 9005

Matte Champagne NEW  
Champagne Opaco

Natural Brown NCS S 8005-Y50R NEW  
Testa di Moro NCS S 8005-Y50R

Code  
Codice

09631 1000

09631 2000

09631 4500

09631 6900

Euro €

118,00

118,00

123,00

123,00



#### A-Tube small



Light source  
Sorgente luminosa

GU10 Par 16  
1x 10 W

W/L max 9 cm  
W/L max 3,54"

Bulb not included  
Lampadina non inclusa

Net weight 0,80 kg  
Peso netto 1,76 lbs   Pack Colli 1

Metal structure  
Montatura in metallo

Matte White - 9010  
Bianco Opaco - 9010

Matte Black - 9005  
Nero Opaco - 9005

Matte Champagne NEW  
Champagne Opaco

Natural Brown NCS S 8005-Y50R NEW  
Testa di Moro NCS S 8005-Y50R

Code  
Codice

09632 1000

09632 2000

09632 4500

09632 6900

VAT excluded  
IVA esclusa

Euro €

164,00

164,00

174,00

174,00

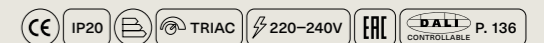

#### A-Tube medium



Light source  
Sorgente luminosa

GU10 Par 16  
1x 10 W

W/L max 9 cm  
W/L max 3,54"

Bulb not included  
Lampadina non inclusa

Net weight 0,90 kg  
Peso netto 1,98 lbs   Pack Colli 1

Metal structure  
Montatura in metallo

Matte White - 9010  
Bianco Opaco - 9010

Matte Black - 9005  
Nero Opaco - 9005

Matte Champagne NEW  
Champagne Opaco

Natural Brown NCS S 8005-Y50R NEW  
Testa di Moro NCS S 8005-Y50R

Code  
Codice

09633 1000

09633 2000

09633 4500

09633 6900

VAT excluded  
IVA esclusa

Euro €

240,00

240,00

255,00

255,00

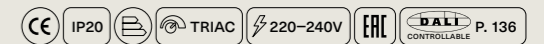

#### A-Tube large

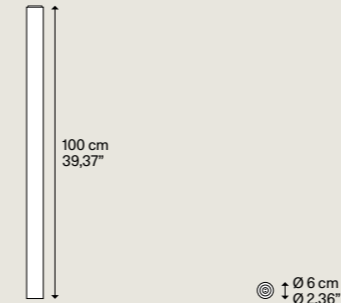

Light source  
Sorgente luminosa

GU10 Par 16  
1x 10 W

W/L max 9 cm  
W/L max 3,54"

Bulb not included  
Lampadina non inclusa

Net weight 1,50 kg  
Peso netto 3,31 lbs   Pack Colli 1

Metal structure  
Montatura in metallo

Matte White - 9010  
Bianco Opaco - 9010

Matte Black - 9005  
Nero Opaco - 9005

Matte Champagne NEW  
Champagne Opaco

Natural Brown NCS S 8005-Y50R NEW  
Testa di Moro NCS S 8005-Y50R

Code  
Codice

09634 1000

09634 2000

09634 4500

09634 6900

VAT excluded  
IVA esclusa

Euro €

337,00

337,00

358,00

358,00

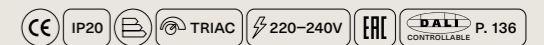

### A-Tube Nano Swing small

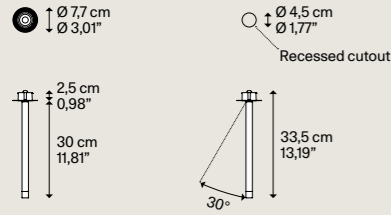

Metal structure Montatura in metallo	Methacrylate diffuser Diffusore in metacrilato	Code Codice	Code Codice	Euro €
Matte Black-9005 Nero Opaco-9005		15832 2020	15832 2035	175,00
Matte Champagne Champagne Opaco		15832 4520	15832 4535	180,00
Gold Oro	Clear Trasparente	15832 5020	15832 5035	200,00
Terra Terra		15832 6720	15832 6735	195,00

**Light source  
Sorgente luminosa**

**LED**

2700	K
3	W
450	lm
350	mA
CRI 90	

**MacAdam 3-Step**

LED and driver included  
LED e driver inclusi

**Light source  
Sorgente luminosa**

**LED**

3000	K
3	W
480	lm
350	mA
CRI 90	

**MacAdam 3-Step**

LED and driver included  
LED e driver inclusi

Net weight Peso netto	0,68 kg 1,49 lbs	Pack Colli	2	Energy class Classe energetica	D
--------------------------	---------------------	---------------	---	-----------------------------------	---

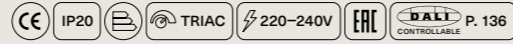

### A-Tube Nano Swing large

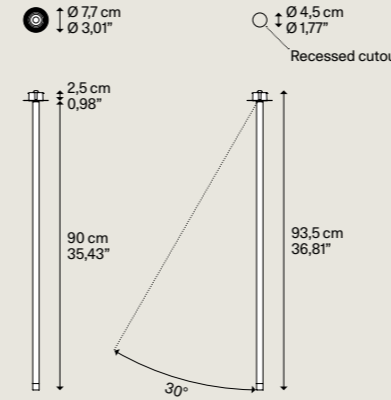

Metal structure Montatura in metallo	Methacrylate diffuser Diffusore in metacrilato	Code Codice	Code Codice	Euro €
Matte Black-9005 Nero Opaco-9005		15834 2020	15834 2035	200,00
Matte Champagne Champagne Opaco		15834 4520	15834 4535	210,00
Gold Oro	Clear Trasparente	15834 5020	15834 5035	250,00
Terra Terra		15834 6720	15834 6735	235,00

**Light source  
Sorgente luminosa**

**LED**

2700	K
3	W
450	lm
350	mA
CRI 90	

**MacAdam 3-Step**

LED and driver included  
LED e driver inclusi

**Light source  
Sorgente luminosa**

**LED**

3000	K
3	W
480	lm
350	mA
CRI 90	

**MacAdam 3-Step**

LED and driver included  
LED e driver inclusi

Net weight Peso netto	0,86 kg 1,89 lbs	Pack Colli	2	Energy class Classe energetica	D
--------------------------	---------------------	---------------	---	-----------------------------------	---



### A-Tube Nano Swing medium

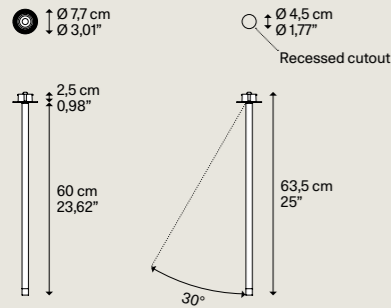

Metal structure Montatura in metallo	Methacrylate diffuser Diffusore in metacrilato	Code Codice	Code Codice	Euro €
Matte Black-9005 Nero Opaco-9005		15833 2020	15833 2035	190,00
Matte Champagne Champagne Opaco		15833 4520	15833 4535	200,00
Gold Oro	Clear Trasparente	15833 5020	15833 5035	225,00
Terra Terra		15833 6720	15833 6735	215,00

**Light source  
Sorgente luminosa**

**LED**

2700	K
3	W
450	lm
350	mA
CRI 90	

**MacAdam 3-Step**

LED and driver included  
LED e driver inclusi

**Light source  
Sorgente luminosa**

**LED**

3000	K
3	W
480	lm
350	mA
CRI 90	

**MacAdam 3-Step**

LED and driver included  
LED e driver inclusi

Net weight Peso netto	0,76 kg 1,67 lbs	Pack Colli	2	Energy class Classe energetica	D
--------------------------	---------------------	---------------	---	-----------------------------------	---



### A-Tube Nano Swing XL

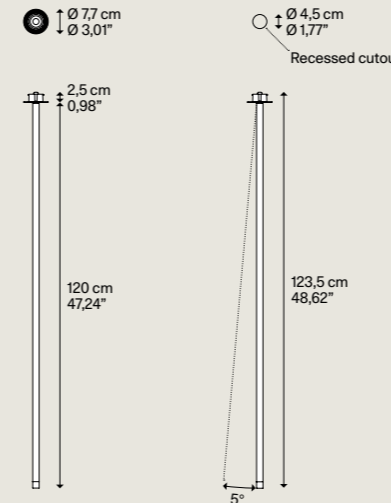

Metal structure Montatura in metallo	Methacrylate diffuser Diffusore in metacrilato	Code Codice	Code Codice	Euro €
Matte Black-9005 Nero Opaco-9005		15835 2020	15835 2035	210,00
Matte Champagne Champagne Opaco		15835 4520	15835 4535	220,00
Gold Oro	Clear Trasparente	15835 5020	15835 5035	275,00
Terra Terra		15835 6720	15835 6735	255,00

**Light source  
Sorgente luminosa**

**LED**

2700	K
3	W
450	lm
350	mA
CRI 90	

**MacAdam 3-Step**

LED and driver included  
LED e driver inclusi

**Light source  
Sorgente luminosa**

**LED**

3000	K
3	W
480	lm
350	mA
CRI 90	

**MacAdam 3-Step**

LED and driver included  
LED e driver inclusi

Net weight Peso netto	0,55 kg 1,21 lbs	Pack Colli	2	Energy class Classe energetica	D
--------------------------	---------------------	---------------	---	-----------------------------------	---



Maximum tilt of 30° for the small, medium, and large versions; maximum tilt of 5° for the XL version.

Inclinazione massima di 30° per le versioni small, medium e large; per la versione XL l'inclinazione massima è di 5°.

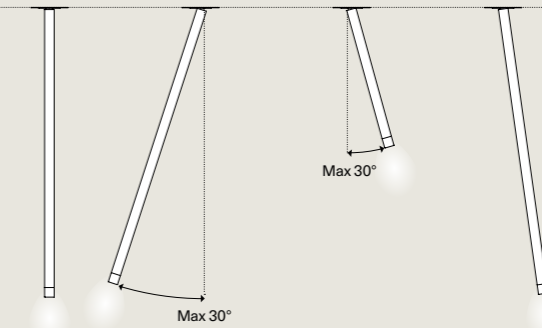

Aile \*

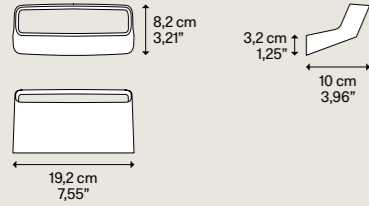

Metal structure Montatura in metallo	Code Codice	Code Codice	Euro €
Matte White - 9010 Bianco Opaco - 9010	17550 1027	17550 1030	169,00
Matte Black - 9005 Nero Opaco - 9005	17550 2027	17550 2030	169,00
Matte Champagne Champagne Opaco	17550 4527	17550 4530	194,00
Lacquer Red Rosso Lacca	17550 6027	17550 6030	225,00

Light source Sorgente luminosa	Code Codice	Euro €
AC LED 2700 K 2x 8 W 1840 lm 220-240 V CRI 92 MacAdam 3-Step	A	169,00
AC LED 3000 K 2x 8 W 1960 lm 220-240 V CRI 92 MacAdam 3-Step	B	169,00

Net weight Peso netto	0,55 kg 1,21 lbs	Pack Colli	1	Energy class Classe energetica	E
--------------------------	---------------------	---------------	---	-----------------------------------	---

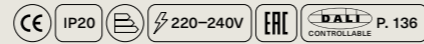

► LED sources with direct power supply to the AC line voltage - driver not required. ► LED con alimentazione diretta a tensione di rete - non necessita di driver.

► \* Available while stocks last.

► \* Disponibile fino ad esaurimento scorte.

Bugia Single

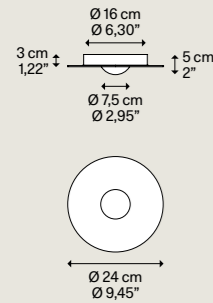

Metal structure Montatura in metallo	Methacrylate diffuser Diffusore in metacrilato	Code Codice	Code Codice	Euro €
Matte White - 9010 Bianco Opaco - 9010	Glossy White Bianco Lucido	16131 1227	16131 1230	250,00
	Glossy Black Nero Lucido	16131 2227	16131 2230	250,00
	Chrome Cromo	16131 4027	16131 4030	250,00
	Glossy Bronze Bronzo Lucido	16131 4627	16131 4630	250,00

Light source Sorgente luminosa	Code Codice	Euro €
AC LED 2700 K 15 W 1320 lm 220-240 V CRI 90 MacAdam 3-Step	A	250,00
AC LED 3000 K 15 W 1440 lm 220-240 V CRI 90 MacAdam 3-Step	B	250,00

Net weight Peso netto	0,80 kg 1,76 lbs	Pack Colli	2	Energy class Classe energetica	F
--------------------------	---------------------	---------------	---	-----------------------------------	---

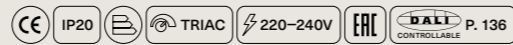

► LED sources with direct power supply to the AC line voltage - driver not required. Dimmable with phase cut dimmer. ► LED con alimentazione diretta a tensione di rete - non necessita di driver. Dimmerabile con varialuce a taglio di fase.

Bugia Double

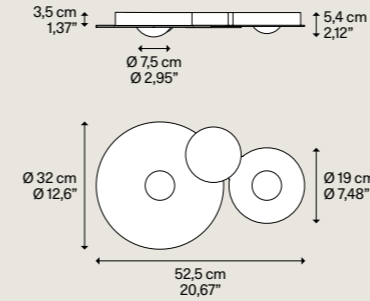

Metal structure Montatura in metallo	Methacrylate diffuser Diffusore in metacrilato	Code Codice	Code Codice	Euro €
Matte White - 9010 Bianco Opaco - 9010	Glossy White Bianco Lucido	16132 1227	16132 1230	444,00
	Glossy Black Nero Lucido	16132 2227	16132 2230	444,00
	Chrome Cromo	16132 4027	16132 4030	444,00
	Glossy Bronze Bronzo Lucido	16132 4627	16132 4630	444,00

Light source Sorgente luminosa	Code Codice	Euro €
AC LED 2700 K 2x 15 W 2640 lm 220-240 V CRI 90 MacAdam 3-Step	A	444,00
AC LED 3000 K 2x 15 W 2880 lm 220-240 V CRI 90 MacAdam 3-Step	B	444,00

Net weight Peso netto	2,05 kg 4,52 lbs	Pack Colli	2	Energy class Classe energetica	F
--------------------------	---------------------	---------------	---	-----------------------------------	---

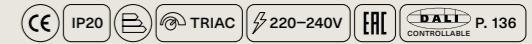

► LED sources with direct power supply to the AC line voltage - driver not required. Dimmable with phase cut dimmer. ► LED con alimentazione diretta a tensione di rete - non necessita di driver. Dimmerabile con varialuce a taglio di fase.

CATEGORY **CEILING LAMP**

**Bugia Mega**

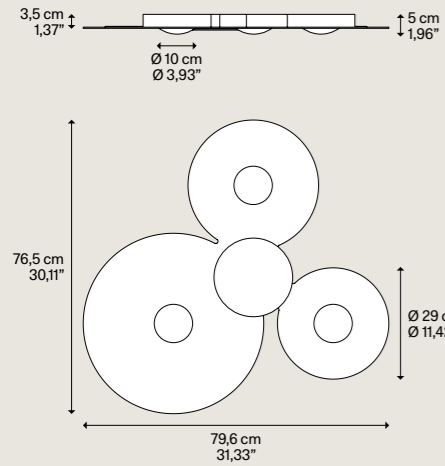

DESIGN **Andrea Tosetto, 2020**

VAT excluded  
IVA esclusa

Metal structure Montatura in metallo	Methacrylate diffuser Diffusore in metacrilato	Code Codice	Code Codice	Euro €
<input type="radio"/> Matte White - 9010 Bianco Opaco - 9010	<input type="radio"/> Glossy White Bianco Lucido	16134 1227	16134 1230	847,00
	<input type="radio"/> Glossy Black Nero Lucido	16134 2227	16134 2230	847,00
	<input type="radio"/> Chrome Cromo	16134 4027	16134 4030	847,00
	<input type="radio"/> Glossy Bronze Bronzo Lucido	16134 4627	16134 4630	847,00

Light source Sorgente luminosa	Code Codice	Euro €
<b>AC LED</b> 2700 K 3x 15 W 3960 lm 220-240 V CRI 90 MacAdam 3-Step LED included LED incluso	<b>A</b>	16134 1227
<b>AC LED</b> 3000 K 3x 15 W 4320 lm 220-240 V CRI 90 MacAdam 3-Step LED included LED incluso	<b>B</b>	16134 1230

Net weight Peso netto	4,40 kg 9,70 lbs	Pack Colli	2	Energy class Classe energetica	F
--------------------------	---------------------	---------------	---	-----------------------------------	---

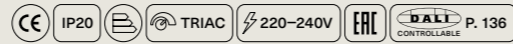

CATEGORY **WALL LAMP**

**Nautilus Dim-to-Warm**

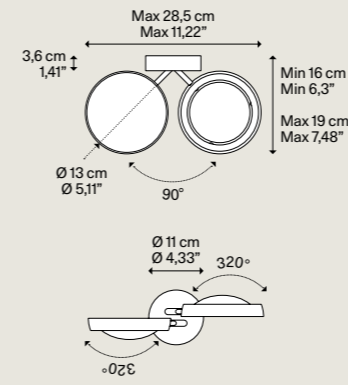

DESIGN **Andrea Tosetto, 2024**

VAT excluded  
IVA esclusa

Metal structure Montatura in metallo	Code Codice	Euro €
<input type="radio"/> Matte White - 9010 Bianco Opaco - 9010	16553 1926	470,00
<input type="radio"/> Matte Black - 9005 Nero Opaco - 9005	16553 2926	470,00
<input type="radio"/> Matte Champagne Champagne Opaco	16553 4926	490,00

Light source Sorgente luminosa	Code Codice	Euro €
<b>LED</b> Dim-to-Warm FROM 2200 K TO 2700 K 2x 7 W 2000 lm 220-240 V CRI 90 MacAdam 3-Step LED and driver included LED e driver inclusi	<b>A</b>	16553 1926
<b>LED</b> Dim-to-Warm FROM 2200 K TO 2700 K 2x 7 W 2000 lm 220-240 V CRI 90 MacAdam 3-Step LED and driver included LED e driver inclusi	<b>B</b>	16553 2926

Net weight Peso netto	1,80 kg 3,96 lbs	Pack Colli	1	Energy class Classe energetica	E
--------------------------	---------------------	---------------	---	-----------------------------------	---

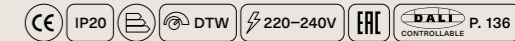

CATEGORY **WALL LAMP**

**Laser**

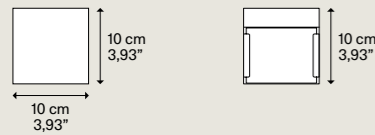

DESIGN **Studio Italia Design, 2015**

VAT excluded  
IVA esclusa

Metal structure Montatura in metallo	Code Codice	Code Codice	Euro €
<input type="radio"/> Matte White - 9010 Bianco Opaco - 9010	03652 1027	03652 1030	174,00
<input type="radio"/> Matte Black - 9005 Nero Opaco - 9005	03652 2027	03652 2030	174,00
<input type="radio"/> Matte Champagne Champagne Opaco	03652 4527	03652 4530	184,00

Light source Sorgente luminosa	Code Codice	Euro €
<b>AC LED</b> 2700 K 2x 16 W 1750 lm 220-240 V CRI 92 MacAdam 3-Step LED included LED incluso	<b>A</b>	03652 1027
<b>AC LED</b> 3000 K 2x 16 W 1850 lm 220-240 V CRI 92 MacAdam 3-Step LED included LED incluso	<b>B</b>	03652 1030

Net weight Peso netto	0,60 kg 1,32 lbs	Pack Colli	1	Energy class Classe energetica	E
--------------------------	---------------------	---------------	---	-----------------------------------	---

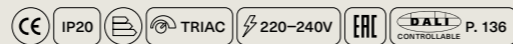

CATEGORY **WALL LAMP**

**Nautilus**

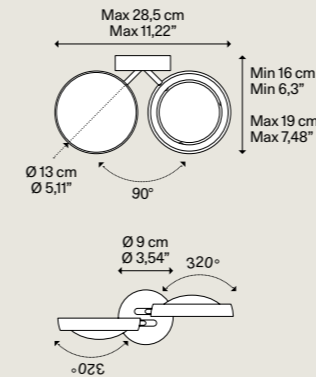

DESIGN **Andrea Tosetto, 2017**

VAT excluded  
IVA esclusa

Metal structure Montatura in metallo	Code Codice	Code Codice	Euro €
<input type="radio"/> Matte White - 9010 Bianco Opaco - 9010	16550 1927	16550 1930	375,00
<input type="radio"/> Matte Black - 9005 Nero Opaco - 9005	16550 2927	16550 2930	375,00
<input type="radio"/> Matte Champagne Champagne Opaco	16550 4927	16550 4930	395,00

Light source Sorgente luminosa	Code Codice	Euro €
<b>AC LED</b> 2700 K 2x 12 W 1990 lm 220-240 V CRI 90 MacAdam 3-Step LED included LED incluso	<b>A</b>	16550 1927
<b>AC LED</b> 3000 K 2x 12 W 2170 lm 220-240 V CRI 90 MacAdam 3-Step LED included LED incluso	<b>B</b>	16550 1930

Net weight Peso netto	1,15 kg 2,54 lbs	Pack Colli	1	Energy class Classe energetica	F
--------------------------	---------------------	---------------	---	-----------------------------------	---

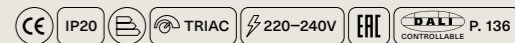

**Adjustable light  
Luce orientabile**

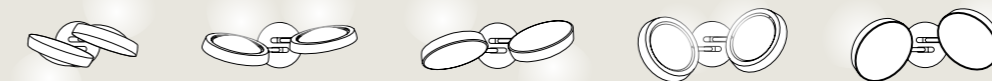

► LED sources with direct power supply to the AC line voltage - driver not required. Dimmable with phase cut dimmer.

► LED con alimentazione diretta a tensione di rete - non necessita di driver. Dimmerabile con varialuce a taglio di fase.

► LED sources with direct power supply to the AC line voltage - driver not required. Dimmable with phase cut dimmer.

► LED con alimentazione diretta a tensione di rete - non necessita di driver. Dimmerabile con varialuce a taglio di fase.

## Nautilus Mini

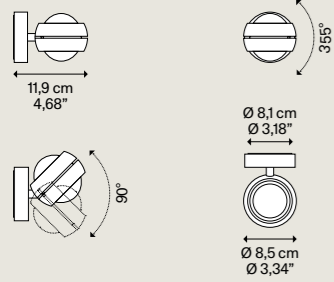

Metal structure Montatura in metallo	Code Codice	Code Codice	Euro €
Matte White – 9010 Bianco Opaco – 9010	16552 1027	16552 1030	265,00
Matte Black – 9005 Nero Opaco – 9005	16552 2027	16552 2030	265,00
Matte Champagne Champagne Opaco	16552 4527	16552 4530	280,00

**Light source**  
Sorgente luminosa

**A**

AC LED	K
2700	12
950	Im
220–240	V
CRI 90	
MacAdam 3-Step	

LED included  
LED incluso

**Light source**  
Sorgente luminosa

**B**

AC LED	K
3000	12
1030	Im
220–240	V
CRI 90	
MacAdam 3-Step	

LED included  
LED incluso

Net weight Peso netto	0,75 kg 1,65 lbs	Pack Colli	1	Energy class Classe energetica	G
--------------------------	---------------------	---------------	---	-----------------------------------	---

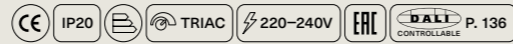

**Adjustable light**  
Luce orientabile



## Nautilus

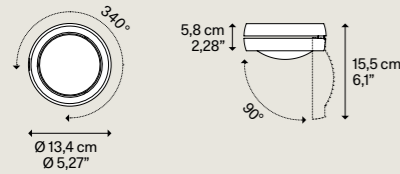

Metal structure Montatura in metallo	Code Codice	Code Codice	Euro €
Matte White – 9010 Bianco Opaco – 9010	16530 1027	16530 1030	260,00
Matte Black – 9005 Nero Opaco – 9005	16530 2027	16530 2030	260,00
Matte Champagne Champagne Opaco	16530 4527	16530 4530	275,00

**Light source**  
Sorgente luminosa

**A**

AC LED	K
2700	12
995	Im
220–240	V
CRI 90	
MacAdam 3-Step	

LED included  
LED incluso

**Light source**  
Sorgente luminosa

**B**

AC LED	K
3000	12
1085	Im
220–240	V
CRI 90	
MacAdam 3-Step	

LED included  
LED incluso

Net weight Peso netto	1,10 kg 2,43 lbs	Pack Colli	1	Energy class Classe energetica	F
--------------------------	---------------------	---------------	---	-----------------------------------	---

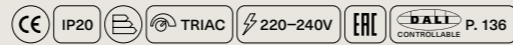

**Adjustable light**  
Luce orientabile



► LED sources with direct power supply to the AC line voltage – driver not required. Dimmable with phase cut dimmer. ► LED con alimentazione diretta a tensione di rete – non necessita di driver. Dimmerabile con varialuce a taglio di fase.

## Nautilus Spot



Metal structure Montatura in metallo	Code Codice	Code Codice	Euro €
Matte White – 9010 Bianco Opaco – 9010	16560 1027	16560 1030	189,00
Matte Black – 9005 Nero Opaco – 9005	16560 2027	16560 2030	189,00
Matte Champagne Champagne Opaco	16560 4527	16560 4530	199,00

**Light source**  
Sorgente luminosa

**A**

AC LED	K
2700	10
945	Im
220–240	V
CRI 90	
MacAdam 3-Step	

LED included  
LED incluso

**Light source**  
Sorgente luminosa

**B**

AC LED	K
3000	10
950	Im
220–240	V
CRI 90	
MacAdam 3-Step	

LED included  
LED incluso

Net weight Peso netto	0,56 kg 1,23 lbs	Pack Colli	1	Energy class Classe energetica	F
--------------------------	---------------------	---------------	---	-----------------------------------	---

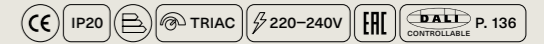

► LED sources with direct power supply to the AC line voltage – driver not required. Dimmable with phase cut dimmer. ► LED con alimentazione diretta a tensione di rete – non necessita di driver. Dimmerabile con varialuce a taglio di fase.

## Pin-Up

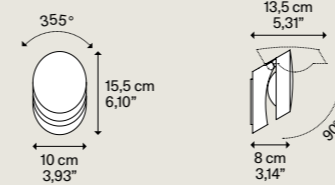

Metal structure Montatura in metallo	Code Codice	Code Codice	Euro €
Matte White – 9010 Bianco Opaco – 9010	15541 1027	15541 1030	235,00
Matte Black – 9005 Nero Opaco – 9005	15541 2027	15541 2030	235,00
Natural Brown NCS S 8005-Y50R NEW Testa di Moro NCS S 8005-Y50R	15541 6927	15541 6930	240,00

**Light source**  
Sorgente luminosa

**A**

AC LED	K
2700	6
475	Im
220–240	V
CRI 90	
MacAdam 3-Step	

LED included  
LED incluso

**Light source**  
Sorgente luminosa

**B**

AC LED	K
3000	6
515	Im
220–240	V
CRI 90	
MacAdam 3-Step	

LED included  
LED incluso

Net weight Peso netto	1,15 kg 2,53 lbs	Pack Colli	1	Energy class Classe energetica	E
--------------------------	---------------------	---------------	---	-----------------------------------	---

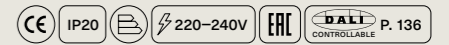

**Adjustable light**  
Luce orientabile



► LED sources with direct power supply to the AC line voltage – driver not required. ► LED con alimentazione diretta a tensione di rete – non necessita di driver.

## Puzzle Round single

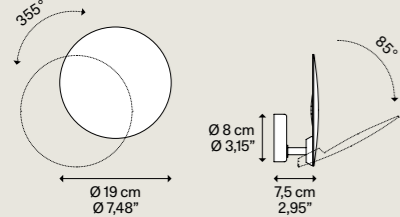

DESIGN Studio Italia Design, 2016

VAT excluded  
IVA esclusa

Metal structure Montatura in metallo	Code Codice	Code Codice	Euro €
Matte White – 9016 Bianco Opaco – 9016	15941 1027	15941 1030	220,00
Matte Black – 9005 Nero Opaco – 9005	15941 2027	15941 2030	220,00
Matte Champagne Champagne Opaco	15941 4527	15941 4530	230,00
Natural Brown NCS S 8005-Y50R <b>NEW</b> Testa di Moro NCS S 8005-Y50R	15941 6927	15941 6930	230,00

**Light source**  
Sorgente luminosa

**A**

AC LED  
2700 K  
16 W  
1750 lm  
220-240 V  
CRI 92  
MacAdam 3-Step

LED included  
LED incluso

**Light source**  
Sorgente luminosa

**B**

AC LED  
3000 K  
16 W  
1850 lm  
220-240 V  
CRI 92  
MacAdam 3-Step

LED included  
LED incluso

Net weight 0,60 kg  
Peso netto 1,32 lbs

Pack Colli 1

Energy class  
Classe energetica E

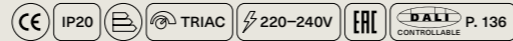

Adjustable light  
Luce orientabile



## Puzzle Round double

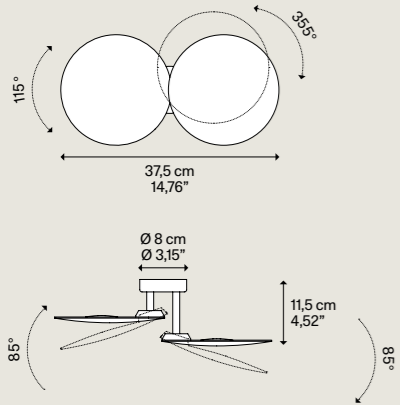

Metal structure Montatura in metallo	Code Codice	Code Codice	Euro €
Matte White – 9016 Bianco Opaco – 9016	15942 1027	15942 1030	403,00
Matte Black – 9005 Nero Opaco – 9005	15942 2027	15942 2030	403,00
Matte Champagne Champagne Opaco	15942 4527	15942 4530	419,00
Natural Brown NCS S 8005-Y50R <b>NEW</b> Testa di Moro NCS S 8005-Y50R	15942 6927	15942 6930	419,00

**Light source**  
Sorgente luminosa

**A**

AC LED  
2700 K  
2x 16 W  
3500 lm  
220-240 V  
CRI 92  
MacAdam 3-Step

LED included  
LED incluso

**Light source**  
Sorgente luminosa

**B**

AC LED  
3000 K  
2x 16 W  
3700 lm  
220-240 V  
CRI 92  
MacAdam 3-Step

LED included  
LED incluso

Net weight 1,10 kg  
Peso netto 2,43 lbs

Pack Colli 1

Energy class  
Classe energetica E

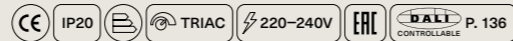

Adjustable light  
Luce orientabile

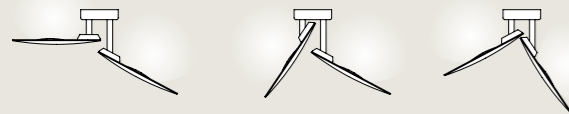

► LED sources with direct power supply to the AC line voltage – driver not required. Dimmable with phase cut dimmer.

► LED con alimentazione diretta a tensione di rete – non necessita di driver. Dimmerabile con varialuce a taglio di fase.

## Puzzle single square

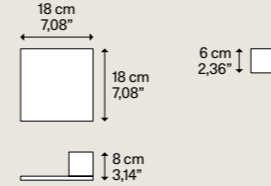

DESIGN Studio Italia Design, 2014

VAT excluded  
IVA esclusa

Metal structure Montatura in metallo	Code Codice	Code Codice	Euro €
Matte White – 9016 Bianco Opaco – 9016	14641 1027	14641 1030	204,00
Matte Black – 9005 Nero Opaco – 9005	14641 2027	14641 2030	204,00

**Light source**  
Sorgente luminosa

**A**

AC LED  
2700 K  
16 W  
1750 lm  
220-240 V  
CRI 92  
MacAdam 3-Step

LED included  
LED incluso

**Light source**  
Sorgente luminosa

**B**

AC LED  
3000 K  
16 W  
1850 lm  
220-240 V  
CRI 92  
MacAdam 3-Step

LED included  
LED incluso

Net weight 1,16 kg  
Peso netto 2,56 lbs

Pack Colli 1

Energy class  
Classe energetica E

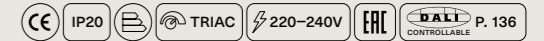

## Puzzle double square

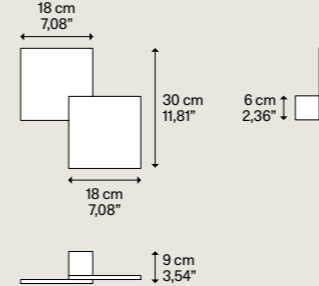

Metal structure Montatura in metallo	Code Codice	Code Codice	Euro €
Matte White – 9016 Bianco Opaco – 9016	14642 1027	14642 1030	327,00
Matte Black – 9005 Nero Opaco – 9005	14642 2027	14642 2030	327,00

**Light source**  
Sorgente luminosa

**A**

AC LED  
2700 K  
2x 16 W  
3500 lm  
220-240 V  
CRI 92  
MacAdam 3-Step

LED included  
LED incluso

**Light source**  
Sorgente luminosa

**B**

AC LED  
3000 K  
2x 16 W  
3700 lm  
220-240 V  
CRI 92  
MacAdam 3-Step

LED included  
LED incluso

Net weight 2,00 kg  
Peso netto 4,41 lbs

Pack Colli 1

Energy class  
Classe energetica E

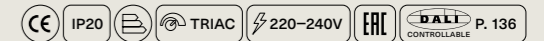

► LED sources with direct power supply to the AC line voltage – driver not required. Dimmable with phase cut dimmer. ► Optional backplate available.

► LED con alimentazione diretta a tensione di rete – non necessita di driver. Dimmerabile con varialuce a taglio di fase. ► Disponibile piastra a muro opzionale.

## Puzzle Mega round small

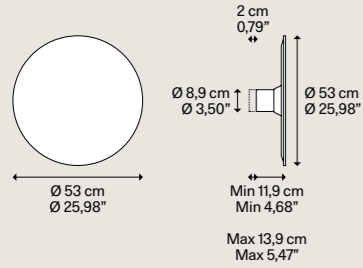

Metal structure Montatura in metallo	MDF diffuser Diffusore in MDF	Code Codice	Euro €
● Matte White - 9016 Bianco Opaco - 9016	● Matte White - 9016 Bianco Opaco - 9016	16746 1023	592,00
	● Matte Black - 9005 Nero Opaco - 9005	16746 2023	663,00
	● Taupe Grigio Caldo	16746 3923	663,00
	● Red Rosso	16746 6023	663,00

**Light source**  
Sorgente luminosa

**LED**  
Turnable White

25 W  
2700 K → 4590 lm  
3000 K → 4690 lm  
550 mA  
CRI 90  
MacAdam 3-Step

LED and driver included  
LED e driver inclusi

Net weight Peso netto	3,80 kg 8,38 lbs	Pack Colli	2	Energy class Classe energetica	C
--------------------------	---------------------	---------------	---	-----------------------------------	---

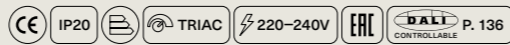

## Puzzle Mega square small

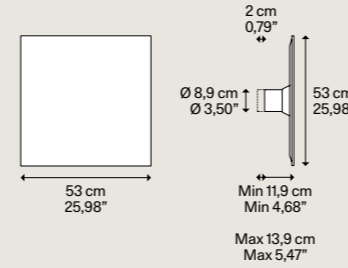

Metal structure Montatura in metallo	MDF diffuser Diffusore in MDF	Code Codice	Euro €
● Matte White - 9016 Bianco Opaco - 9016	● Matte White - 9016 Bianco Opaco - 9016	16747 1023	592,00
	● Matte Black - 9005 Nero Opaco - 9005	16747 2023	663,00
	● Taupe Grigio Caldo	16747 3923	663,00
	● Red Rosso	16747 6023	663,00

**Light source**  
Sorgente luminosa

**LED**  
Turnable White

25 W  
2700 K → 4590 lm  
3000 K → 4690 lm  
550 mA  
CRI 90  
MacAdam 3-Step

LED and driver included  
LED e driver inclusi

Net weight Peso netto	4,10 kg 9,04 lbs	Pack Colli	2	Energy class Classe energetica	C
--------------------------	---------------------	---------------	---	-----------------------------------	---

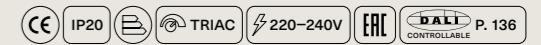

## Puzzle Mega round large

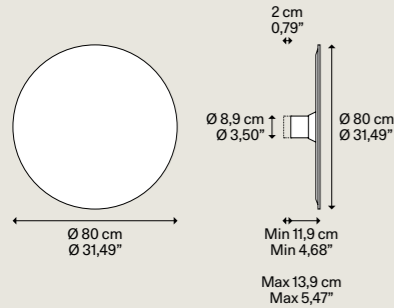

Metal structure Montatura in metallo	MDF diffuser Diffusore in MDF	Code Codice	Euro €
● Matte White - 9016 Bianco Opaco - 9016	● Matte White - 9016 Bianco Opaco - 9016	16748 1023	1.000,00
	● Matte Black - 9005 Nero Opaco - 9005	16748 2023	1.102,00
	● Taupe Grigio Caldo	16748 3923	1.102,00
	● Red Rosso	16748 6023	1.102,00

**Light source**  
Sorgente luminosa

**LED**  
Turnable White

33 W  
2700 K → 5980 lm  
3000 K → 6120 lm  
700 mA  
CRI 90  
MacAdam 3-Step

LED and driver included  
LED e driver inclusi

Net weight Peso netto	7,20 kg 15,87 lbs	Pack Colli	2	Energy class Classe energetica	C
--------------------------	----------------------	---------------	---	-----------------------------------	---



## Puzzle Mega square large

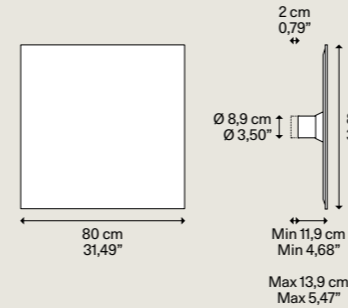

Metal structure Montatura in metallo	MDF diffuser Diffusore in MDF	Code Codice	Euro €
● Matte White - 9016 Bianco Opaco - 9016	● Matte White - 9016 Bianco Opaco - 9016	16749 1023	1.000,00
	● Matte Black - 9005 Nero Opaco - 9005	16749 2023	1.102,00
	● Taupe Grigio Caldo	16749 3923	1.102,00
	● Red Rosso	16749 6023	1.102,00

**Light source**  
Sorgente luminosa

**LED**  
Turnable White

33 W  
2700 K → 5980 lm  
3000 K → 6120 lm  
700 mA  
CRI 90  
MacAdam 3-Step

LED and driver included  
LED e driver inclusi

Net weight Peso netto	8,80 kg 19,40 lbs	Pack Colli	2	Energy class Classe energetica	C
--------------------------	----------------------	---------------	---	-----------------------------------	---



► LED sources with direct power supply to the AC line voltage – driver not required. Dimmable with phase cut dimmer. ► You can connect up to 4 Puzzle Mega to each fixture directly connected to the power supply. You can also connect up to 3 additional fixtures to each of those for maximum total of 36 fixtures on a single power outlet.

► LED con alimentazione diretta a tensione di rete – non necessita di driver. Dimmerabile con varialuce a taglio di fase. ► Ad ogni Puzzle Mega connessa al punto di alimentazione elettrica possono esserne collegate altre 4. Ad ognuna di queste possono esserne collegate fino ad altre 3 e così via. Le lampade totali collegabili su un singolo punto di alimentazione sono 36.

► LED sources with direct power supply to the AC line voltage – driver not required. Dimmable with phase cut dimmer. ► You can connect up to 4 Puzzle Mega to each fixture directly connected to the power supply. You can also connect up to 3 additional fixtures to each of those for maximum total of 36 fixtures on a single power outlet.

► LED con alimentazione diretta a tensione di rete – non necessita di driver. Dimmerabile con varialuce a taglio di fase. ► Ad ogni Puzzle Mega connessa al punto di alimentazione elettrica possono esserne collegate altre 4. Ad ognuna di queste possono esserne collegate fino ad altre 3 e così via. Le lampade totali collegabili su un singolo punto di alimentazione sono 36.

### Puzzle Mega extension

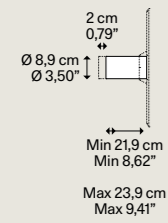

**Description**  
Descrizione

Extension optional ► to be used to widen the light beam in case of ceiling installation.

Estensione opzionale ► da utilizzare per ampliare il fascio luminoso in caso di installazione a soffitto.

**Metal structure**  
Montatura in metallo

- Matte White - 9016
- Bianco Opaco - 9016

**Code**  
Codice

16799 A200

**Euro €**

67,00

Net weight	0,86 kg	Pack	1
Peso netto	1,86 lbs	Colli	



#### Puzzle Mega standard version Puzzle Mega versione standard

#### Puzzle Mega extension optional version Puzzle Mega versione estensione opzionale

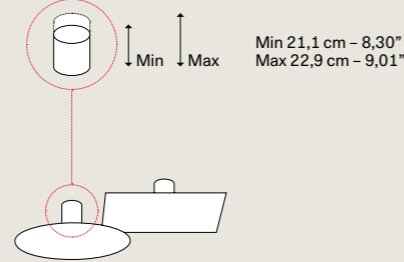
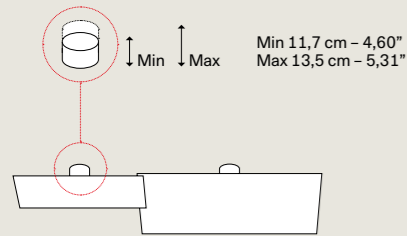

### Accessory connector



**Description**  
Descrizione

Connection ► to be used to connect the fixtures together in the compositions.

Collegamento ► da utilizzare per collegare le lampade tra loro nelle composizioni.

**Code**  
Codice

16799 A100

**Euro €**

39,00

Net weight	0,10 kg	Pack	1
Peso netto	0,22 lbs	Colli	



#### Accessory connector Accessorio di collegamento

Main power connection

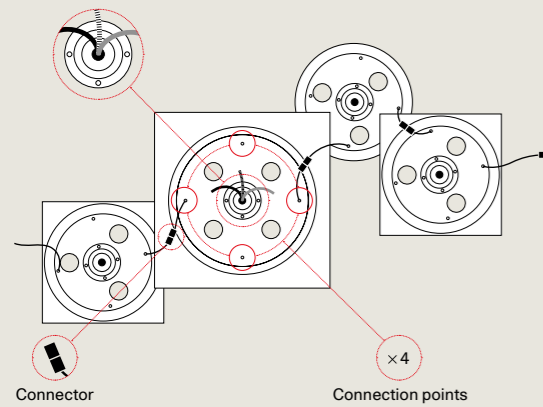

Connector

Connection points  
×4

### Spider

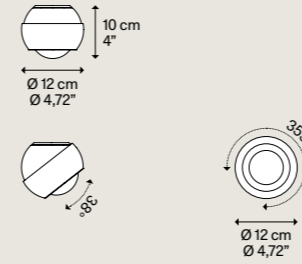

**Metal structure**  
Montatura in metallo

- Chrome
- Cromo

**Metal diffuser**  
Diffusore in metallo

- Matte White - 9010  
Bianco Opaco - 9010
- Matte Black - 9005  
Nero Opaco - 9005
- Extra Matte Champagne  
Champagne Extra Opaco
- Extra Matte Terra  
Terra Extra Opaco

**Code**  
Codice

18340 1027

**Code**  
Codice

18340 1030

**Euro €**

300,00

300,00

317,00

327,00

**Adjustable light**  
Luce orientabile



**Light source**  
Sorgente luminosa

AC LED  
2700 K  
10 W  
920 lm  
220-240 V  
CRI 90  
MacAdam 3-Step

LED included  
LED incluso

**Light source**  
Sorgente luminosa

AC LED  
3000 K  
10 W  
980 lm  
220-240 V  
CRI 90  
MacAdam 3-Step

LED included  
LED incluso

Net weight	0,86 kg	Pack	2	Energy class	F
Peso netto	1,89 lbs	Colli		Classe energetica	

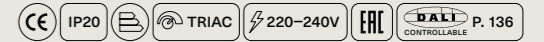

► LED sources with direct power supply to the AC line voltage - driver not required. Dimmable with phase cut dimmer.

► LED con alimentazione diretta a tensione di rete - non necessita di driver. Dimmerabile con varialuce a taglio di fase.

### Tidal 45

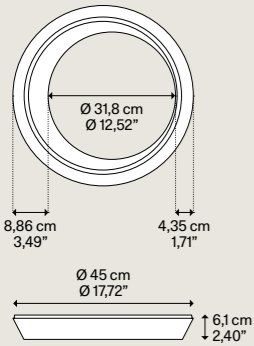

Net weight	2,80 kg	Pack	1	Energy class	C
Peso netto	6,17 lbs	Colli		Classe energetica	

### Tidal 60

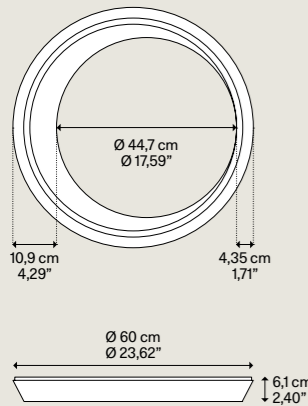

Net weight	3,90 kg	Pack	1	Energy class	C
Peso netto	8,60 lbs	Colli		Classe energetica	

### Metal structure

Matte White - 9010 Bianco Opaco - 9010	
Matte Black - 9005 Nero Opaco - 9005	
Extra Matte Champagne Champagne Extra Opaco	
Extra Matte Terra Terra Extra Matte	
Matte White - 9010 Bianco Opaco - 9010	
Matte Black - 9005 Nero Opaco - 9005	
Extra Matte Champagne Champagne Extra Opaco	
Extra Matte Terra Terra Extra Matte	

### Type of dimming

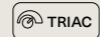

Code Codice	Code Codice	Euro €
19931 1027	19931 1030	498,00
19931 2027	19931 2030	498,00
19931 4527	19931 4530	524,00
19931 6727	19931 6730	550,00
19934 1027	19934 1030	628,00
19934 2027	19934 2030	628,00
19934 4527	19934 4530	654,00
19934 6727	19934 6730	680,00

**Light source**  
Sorgente luminosa

LED  
2700 K  
27 W  
5040 lm  
1100 mA  
CRI 90  
MacAdam 3-Step

LED and driver included  
LED e driver inclusi

**Light source**  
Sorgente luminosa

LED  
3000 K  
27 W  
5292 lm  
1100 mA  
CRI 90  
MacAdam 3-Step

LED and driver included  
LED e driver inclusi

CE	IP20	TRIAC	DALI	220-240V	ERC	DALI CONTROLLABLE P. 136
----	------	-------	------	----------	-----	--------------------------

### Metal structure

Matte White - 9010 Bianco Opaco - 9010	
Matte Black - 9005 Nero Opaco - 9005	
Extra Matte Champagne Champagne Extra Opaco	
Extra Matte Terra Terra Extra Matte	
Matte White - 9010 Bianco Opaco - 9010	
Matte Black - 9005 Nero Opaco - 9005	
Extra Matte Champagne Champagne Extra Opaco	
Extra Matte Terra Terra Extra Matte	

### Type of dimming

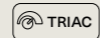

Code Codice	Code Codice	Euro €
19933 1027	19933 1030	682,00
19933 2027	19933 2030	682,00
19933 4527	19933 4530	712,00
19933 6727	19933 6730	743,00
19935 1027	19935 1030	824,00
19935 2027	19935 2030	824,00
19935 4527	19935 4530	854,00
19935 6727	19935 6730	885,00

**Light source**  
Sorgente luminosa

LED  
2700 K  
37 W  
6975 lm  
Direct light > 600 mA  
Indirect light > 350 mA  
CRI 90  
MacAdam 3-Step

LED and driver included Double switch  
LED e driver inclusi Doppia accensione

The driver, included, is supplied with an output voltage of 600 mA but can be adjusted during installation

Il driver, incluso, è fornito con una corrente di uscita impostata a 600 mA ma può essere regolato in installazione

▶ 500 mA 40 W 6083 lm  
▶ 550 mA 44 W 6529 lm

**Light source**  
Sorgente luminosa

LED  
3000 K  
37 W  
7320 lm  
Direct light > 600 mA  
Indirect light > 350 mA  
CRI 90  
MacAdam 3-Step

LED and driver included Double switch  
LED e driver inclusi Doppia accensione

The driver, included, is supplied with an output voltage of 600 mA but can be adjusted during installation

Il driver, incluso, è fornito con una corrente di uscita impostata a 600 mA ma può essere regolato in installazione

▶ 500 mA 40 W 6385 lm  
▶ 550 mA 44 W 6853 lm

CE	IP20	TRIAC	DALI	220-240V	ERC	DALI CONTROLLABLE P. 136
----	------	-------	------	----------	-----	--------------------------

### Tidal 75

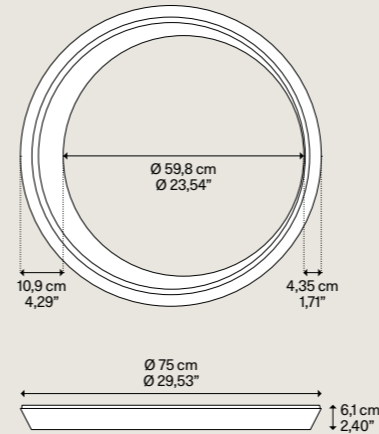

Net weight	5,38 kg	Pack	1	Energy class	C
Peso netto	11,86 lbs	Colli		Classe energetica	

### Metal structure

Matte White - 9010 Bianco Opaco - 9010	
Matte Black - 9005 Nero Opaco - 9005	
Extra Matte Champagne Champagne Extra Opaco	
Extra Matte Terra Terra Extra Matte	
Matte White - 9010 Bianco Opaco - 9010	
Matte Black - 9005 Nero Opaco - 9005	
Extra Matte Champagne Champagne Extra Opaco	
Extra Matte Terra Terra Extra Matte	

### Type of dimming

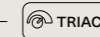

Code Codice	Code Codice	Euro €
19932 1027	19932 1030	880,00
19932 2027	19932 2030	880,00
19932 4527	19932 4530	930,00
19932 6727	19932 6730	980,00
19936 1027	19936 1030	1.066,00
19936 2027	19936 2030	1.066,00
19936 4527	19936 4530	1.116,00
19936 6727	19936 6730	1.166,00

**Light source**  
Sorgente luminosa

LED  
2700 K  
46 W  
8589 lm  
Direct light > 700 mA  
Indirect light > 550 mA  
CRI 90  
MacAdam 3-Step

LED and driver included Double switch  
LED e driver inclusi Doppia accensione

The driver, included, is supplied with an output voltage of 700 mA but can be adjusted during installation

Il driver, incluso, è fornito con una corrente di uscita impostata a 700 mA ma può essere regolato in installazione

▶ 500 mA 39 W 6855 lm  
▶ 550 mA 43 W 7289 lm  
▶ 600 mA 47 W 7722 lm

**Light source**  
Sorgente luminosa

LED  
3000 K  
46 W  
9072 lm  
Direct light > 700 mA  
Indirect light > 550 mA  
CRI 90  
MacAdam 3-Step

LED and driver included Double switch  
LED e driver inclusi Doppia accensione

The driver, included, is supplied with an output voltage of 700 mA but can be adjusted during installation

Il driver, incluso, è fornito con una corrente di uscita impostata a 700 mA ma può essere regolato in installazione

▶ 500 mA 39 W 7236 lm  
▶ 550 mA 43 W 7695 lm  
▶ 600 mA 47 W 8154 lm

CE	IP20	TRIAC	DALI	220-240V	ERC	DALI CONTROLLABLE P. 136
----	------	-------	------	----------	-----	--------------------------

### Light emission

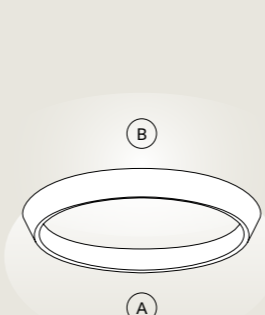

	Tidal 45			Tidal 60			Tidal 75		
A Direct light emission Emissione di luce diretta	2700 K	3600 lm	-	2700 K	4463 lm	500 mA	2700 K	4335 lm	500 mA
					4909 lm	550 mA		4769 lm	550 mA
					5355 lm	600 mA		5202 lm	600 mA
								6069 lm	700 mA
B Indirect light emission Emissione di luce indiretta	3000 K	3780 lm	-	3000 K	4675 lm	500 mA	3000 K	4590 lm	500 mA
					5143 lm	550 mA		5049 lm	550 mA
					5610 lm	600 mA		5508 lm	600 mA
								6426 lm	700 mA
	2700 K	1440 lm	-	2700 K	1620 lm	-	2700 K	2520 lm	-
	3000 K	1512 lm	-	3000 K	1710 lm	-	3000 K	2646 lm	-

### Shift small

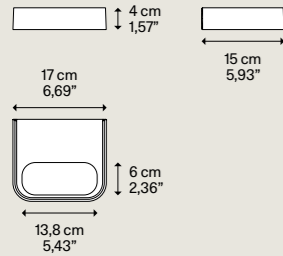

Light source Sorgente luminosa		Light source Sorgente luminosa	
A		B	
LED	K	LED	K
2700	16	3000	16
2495	500	2580	500
Im	mA	Im	mA
CRI 90		CRI 90	
MacAdam 3-Step		MacAdam 3-Step	
LED and driver included LED e driver inclusi		LED and driver included LED e driver inclusi	

Net weight	1,60 kg	Pack	1	Energy class	D
Peso netto	3,52 lbs	Colli		Classe energetica	

Metal structure Montatura in metallo		Code Codice	Code Codice	VAT excluded IVA esclusa
		A	B	Euro €
Matte White - 9010 Bianco Opaco - 9010		21551 1027	21551 1030	180,00
Matte Black - 9005 Nero Opaco - 9005		21551 2027	21551 2030	180,00
Extra Matte Champagne Champagne Extra Opaco		21551 4527	21551 4530	190,00
Natural Brown NCS S 8005-Y50R Testa di Moro NCS S 8005-Y50R		21551 6927	21551 6930	185,00

Metal structure Montatura in metallo		Code Codice	Code Codice	VAT excluded IVA esclusa
		A	B	Euro €
Matte White - 9010 Bianco Opaco - 9010		21553 1027	21553 1030	240,00
Matte Black - 9005 Nero Opaco - 9005		21553 2027	21553 2030	240,00
Extra Matte Champagne Champagne Extra Opaco		21553 4527	21553 4530	250,00
Natural Brown NCS S 8005-Y50R Testa di Moro NCS S 8005-Y50R		21553 6927	21553 6930	245,00

CE	IP20	TRIAC	DALI	220-240V	⏚
----	------	-------	------	----------	---

### Shift large

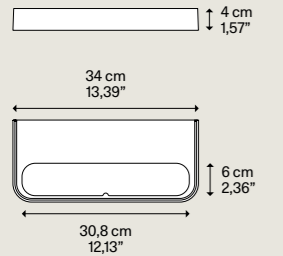

Light source Sorgente luminosa		Light source Sorgente luminosa	
A		B	
LED	K	LED	K
2700	32,5	3000	32,5
5085	700	5255	700
Im	mA	Im	mA
CRI 90		CRI 90	
MacAdam 3-Step		MacAdam 3-Step	
LED and driver included LED e driver inclusi		LED and driver included LED e driver inclusi	

Net weight	3,00 kg	Pack	1	Energy class	D
Peso netto	6,61 lbs	Colli		Classe energetica	

Metal structure Montatura in metallo		Code Codice	Code Codice	VAT excluded IVA esclusa
		A	B	Euro €
Matte White - 9010 Bianco Opaco - 9010		21552 1027	21552 1030	250,00
Matte Black - 9005 Nero Opaco - 9005		21552 2027	21552 2030	250,00
Extra Matte Champagne Champagne Extra Opaco		21552 4527	21552 4530	265,00
Natural Brown NCS S 8005-Y50R Testa di Moro NCS S 8005-Y50R		21552 6927	21552 6930	260,00

Metal structure Montatura in metallo		Code Codice	Code Codice	VAT excluded IVA esclusa
		A	B	Euro €
Matte White - 9010 Bianco Opaco - 9010		21554 1027	21554 1030	370,00
Matte Black - 9005 Nero Opaco - 9005		21554 2027	21554 2030	370,00
Extra Matte Champagne Champagne Extra Opaco		21554 4527	21554 4530	385,00
Natural Brown NCS S 8005-Y50R Testa di Moro NCS S 8005-Y50R		21554 6927	21554 6930	380,00

CE	IP20	TRIAC	DALI	220-240V	⏚
----	------	-------	------	----------	---

#### The light emission angle Angolo di emissione della luce

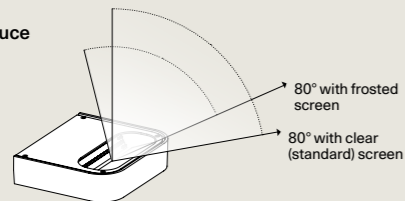

### Volum mirror 14

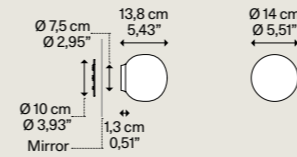

Net weight	0,74 kg	Pack	2
Peso netto	1,63 lbs	Colli	

Silicone structure Struttura in silicone	Blown glass diffuser Diffusore in vetro soffiato	Code Codice	VAT excluded IVA esclusa
			Euro €
Translucent Traslucido	Glossy White Bianco Lucido	18741 120S	210,00

**Light source  
Sorgente luminosa**

**E14 LED T18** Ø max 5 cm  
 1x 5 W Ø max 1,96"  
 (max 10 W) W/L max 9 cm  
 W/L max 3,54"

Light bulb to be ordered separately  
 Lampadina da ordinare separatamente

CE	IP54	TRIAC	220-240V	ERC	DALI CONTROLLABLE P. 136
----	------	-------	----------	-----	--------------------------

### Volum mirror 22

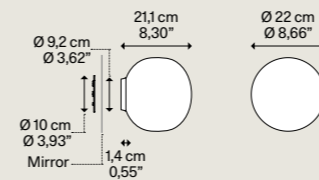

Net weight	1,15 kg	Pack	2
Peso netto	2,53 lbs	Colli	

Silicone structure Struttura in silicone	Blown glass diffuser Diffusore in vetro soffiato	Code Codice	VAT excluded IVA esclusa
			Euro €
Translucent Traslucido	Glossy White Bianco Lucido	18742 120S	307,00

**Light source  
Sorgente luminosa**

**E27 LED T28** Ø max 5 cm  
 1x 10 W Ø max 1,96"  
 (max 25 W) W/L max 12,5 cm  
 W/L max 4,92"

Light bulb to be ordered separately  
 Lampadina da ordinare separatamente

CE	IP54	TRIAC	220-240V	ERC	DALI CONTROLLABLE P. 136
----	------	-------	----------	-----	--------------------------

### Volum mirror 29

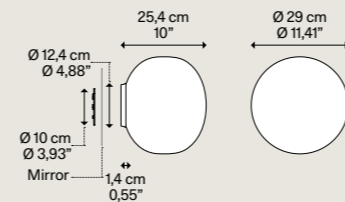

Net weight	2,16 kg	Pack	2
Peso netto	4,76 lbs	Colli	

Silicone structure Struttura in silicone	Blown glass diffuser Diffusore in vetro soffiato	Code Codice	VAT excluded IVA esclusa
			Euro €
Translucent Traslucido	Glossy White Bianco Lucido	18743 120S	373,00

**Light source  
Sorgente luminosa**

**E27 LED T35** Ø max 8,5 cm  
 1x 13 W Ø max 3,34"  
 (max 25 W)

Light bulb to be ordered separately  
 Lampadina da ordinare separatamente

CE	IP54	TRIAC	220-240V	ERC	DALI CONTROLLABLE P. 136
----	------	-------	----------	-----	--------------------------

CATEGORY WALL LAMP CEILING LAMP

## Volum mirror 42

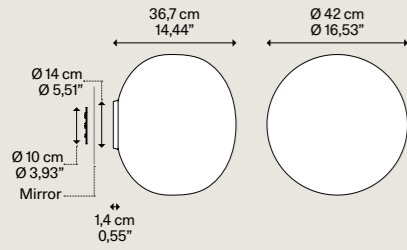

Net weight 3,39 kg  
Peso netto 7,47 lbs  
Pack Colli 2

DESIGN Snøhetta, 2023

VAT excluded  
IVA esclusa

Silicone structure  
Struttura in silicone

Translucent  
Traslucido

Blown glass diffuser  
Diffusore in vetro soffiato

Glossy White  
Bianco Lucido

Code  
Codice

18744 120S

Euro €

541,00

Light source  
Sorgente luminosa

E27 LED T35 Ø max 8,5 cm  
1 x 21 W Ø max 3,34"  
(max 25 W)

Light bulb to be ordered separately  
Lampadina da ordinare separatamente

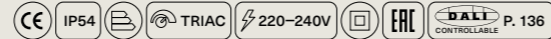

Application  
Applicazione

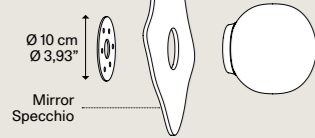

CATEGORY WALL LAMP CEILING LAMP

## Volum 14

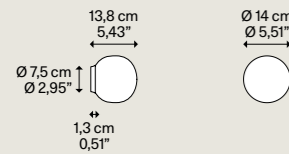

Net weight 0,74 kg  
Peso netto 1,63 lbs  
Pack Colli 2

DESIGN Snøhetta, 2023

VAT excluded  
IVA esclusa

Silicone structure  
Struttura in silicone

Translucent  
Traslucido

Blown glass diffuser  
Diffusore in vetro soffiato

Glossy White  
Bianco Lucido

Code  
Codice

18741 1200

Euro €

169,00

Light source  
Sorgente luminosa

E14 LED T18 Ø max 5 cm  
1 x 5 W Ø max 1,96"  
(max 10 W) W/L max 9 cm  
W/L max 3,54"

Light bulb to be ordered separately  
Lampadina da ordinare separatamente

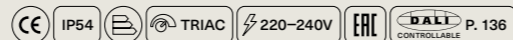

## Volum 22

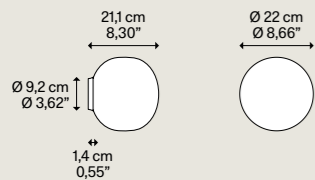

Net weight 1,15 kg  
Peso netto 2,53 lbs  
Pack Colli 2

Silicone structure  
Struttura in silicone

Translucent  
Traslucido

Blown glass diffuser  
Diffusore in vetro soffiato

Glossy White  
Bianco Lucido

Code  
Codice

18742 1200

Euro €

266,00

Light source  
Sorgente luminosa

E27 LED T28 Ø max 5 cm  
1 x 10 W Ø max 1,96"  
(max 25 W) W/L max 12,5 cm  
W/L max 4,92"

Light bulb to be ordered separately  
Lampadina da ordinare separatamente

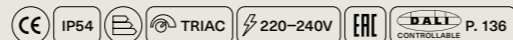

CATEGORY WALL LAMP CEILING LAMP

## Volum 29

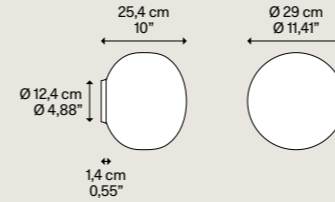

Net weight 2,16 kg  
Peso netto 4,76 lbs  
Pack Colli 2

DESIGN Snøhetta, 2023

VAT excluded  
IVA esclusa

Silicone structure  
Struttura in silicone

Translucent  
Traslucido

Blown glass diffuser  
Diffusore in vetro soffiato

Glossy White  
Bianco Lucido

Code  
Codice

18743 1200

Euro €

332,00

Light source  
Sorgente luminosa

E27 LED T35 Ø max 8,5 cm  
1 x 13 W Ø max 3,34"  
(max 25 W)

Light bulb to be ordered separately  
Lampadina da ordinare separatamente

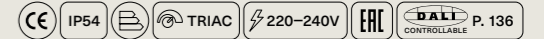

## Volum 42

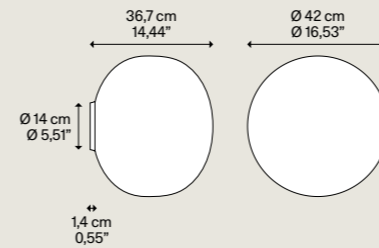

Net weight 3,39 kg  
Peso netto 7,47 lbs  
Pack Colli 2

Silicone structure  
Struttura in silicone

Translucent  
Traslucido

Blown glass diffuser  
Diffusore in vetro soffiato

Glossy White  
Bianco Lucido

Code  
Codice

18744 1200

VAT excluded  
IVA esclusa

500,00

Light source  
Sorgente luminosa

E27 LED T35 Ø max 8,5 cm  
1 x 21 W Ø max 3,34"  
(max 25 W)

Light bulb to be ordered separately  
Lampadina da ordinare separatamente



Light source  
Sorgente luminosa

E14 LED T18 2700 K CRI 90  
5 W 500 lm MacAdam 3-Step

E27 LED T28 2700 K CRI 90  
10 W 1000 lm MacAdam 3-Step

E27 LED T35 2700 K CRI 90  
13 W 1500 lm MacAdam 3-Step

E27 LED T35 2700 K CRI 90  
21 W 2010 lm MacAdam 3-Step

Bulb dimension  
Dimensione lampadina

Ø 1,8 cm W/L 6,1 cm  
Ø 0,70" W/L 2,40"

Ø 2,8 cm W/L 11,3 cm  
Ø 1,10" W/L 4,44"

Ø 3,5 cm W/L 15 cm  
Ø 1,37" W/L 5,90"

Ø 3,5 cm W/L 15 cm  
Ø 1,37" W/L 5,90"

Lamp  
Lampada

Volum 14  
P. 087, 088

Volum 22  
P. 087, 088

Volum 29  
P. 087, 089

Volum 42  
P. 088, 089

Pack  
Colli

1

1

1

1

Code  
Codice

LAM-0017

LAM-0014

LAM-0015

LAM-0016

VAT excluded  
IVA esclusa

Euro €

25,00

30,00

40,00

48,00

Dimmable bulbs / Lampadine dimmerabili

# Floor & Table lamps

## Floor lamps

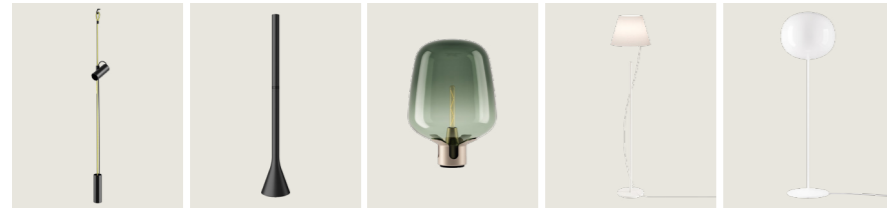

Cima P. 091    Croma P. 092    Flar P. 093    Hover P. 094    Volum P. 100, 101

## Table lamps

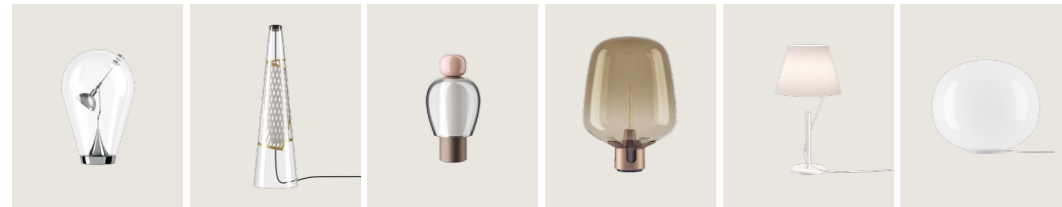

Blow P. 095    Cono di Luce P. 096    Easy Peasy P. 097    Flar P. 093    Hover P. 094    Volum P. 098, 099

CATEGORY **SUSPENSION LAMP** **FLOOR LAMP**

DESIGN Marco Dessì, 2021

VAT excluded  
IVA esclusa

### Cima

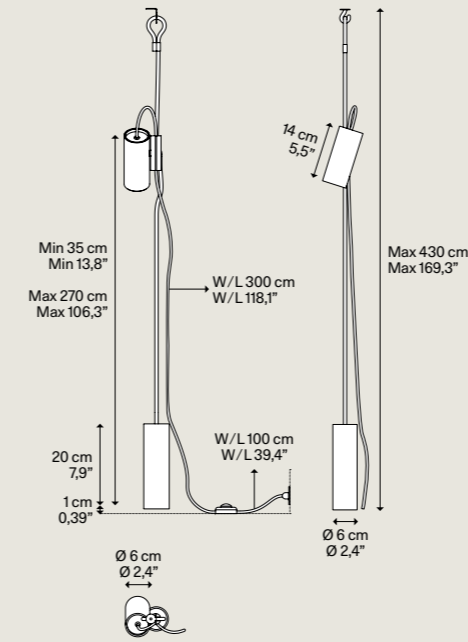

Metal structure Montatura in metallo	Rope Corda	Code Codice	Euro €
● Matte Black Nero Opaco	● Silver Argento	17371 4100	304,00
	● Gold Oro	17371 5000	304,00
	● Yellow Giallo	17371 5100	304,00

#### Light source Sorgente luminosa

GU10 Par 16 LED 1x 10 W W/L max 9 cm W/L max 3,54"

Bulb and dimmer not included  
Lampadina e dimmer non inclusi

#### Description Descrizione

Additional kit (max 1 additional kit).

Metal structure Montatura in metallo	Code Codice	Euro €
● Matte Black Nero Opaco	17371K 2000	199,00

#### Light source Sorgente luminosa

GU10 Par 16 LED 1x 10 W W/L max 9 cm W/L max 3,54"

Bulb and dimmer not included  
Lampadina e dimmer non inclusi

Net weight 1,75 kg  
Peso netto 3,86 lbs Pack Colli 1



#### Adjustable light Luce orientabile

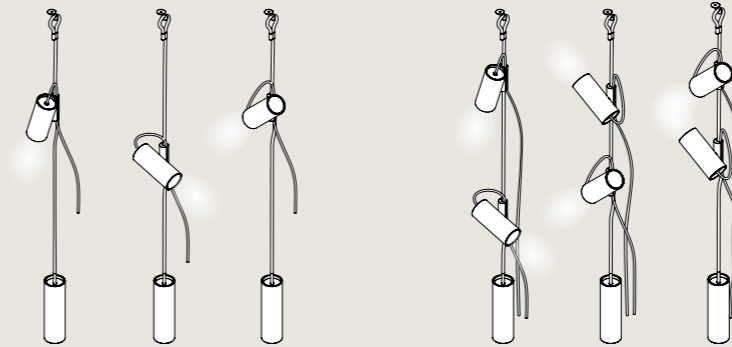

SUSPENSION LAMP  
CLUSTER SUSPENSION LAMP  
CANOPY  
WALL & CEILING LAMP  
FLOOR & TABLE LAMP  
SYSTEM  
ACCESSORY

Croma \*

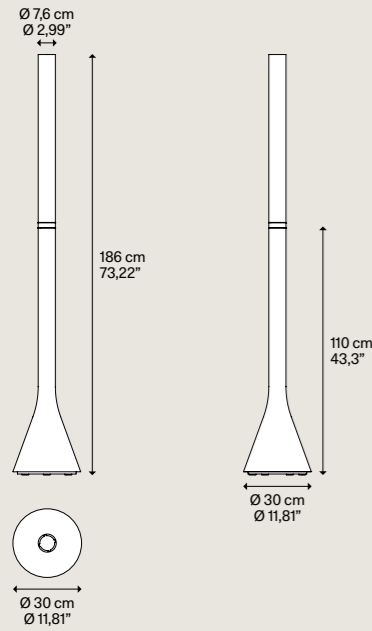

Net weight	15,00 kg	Pack	1	Energy class	E
Peso netto	33,07 lbs	Colli		Classe energetica	

Metal structure Montatura in metallo	Code Codice	Euro €
Matte White - 9010 Bianco Opaco - 9010	17270 1000	1.580,00
Matte Black - 9005 Nero Opaco - 9005	17270 2000	1.580,00
Bronze Bronzo	17270 3400	2.295,00

Light source  
Sorgente luminosa

LED  
Dim-to-Warm  
FROM 2200 K  
TO 3200 K  
42 W  
5600 lm  
220-240 V  
CRI 90  
MacAdam 3-Step

Dim-to-Warm		
▶ 20%	2200 K	1400 lm
▶ 40%	2600 K	2400 lm
▶ 60%	2850 K	3550 lm
▶ 80%	3000 K	4600 lm
▶ 100%	3200 K	5600 lm

LED, driver and Dim-to-Warm dimmer included  
LED, driver e Dim-to-Warm dimmer inclusi



Dim-to-Warm from 2200 to 3200 K

The Dim-to-Warm function allows users to interact with the lamp, adjusting the LED light intensity and color temperature from 2700 to 3200 Kelvin.

La funzione Dim-to-Warm consente agli utenti di interagire con la lampada, regolando l'intensità e la temperatura della luce LED da 2700 a 3200 Kelvin.

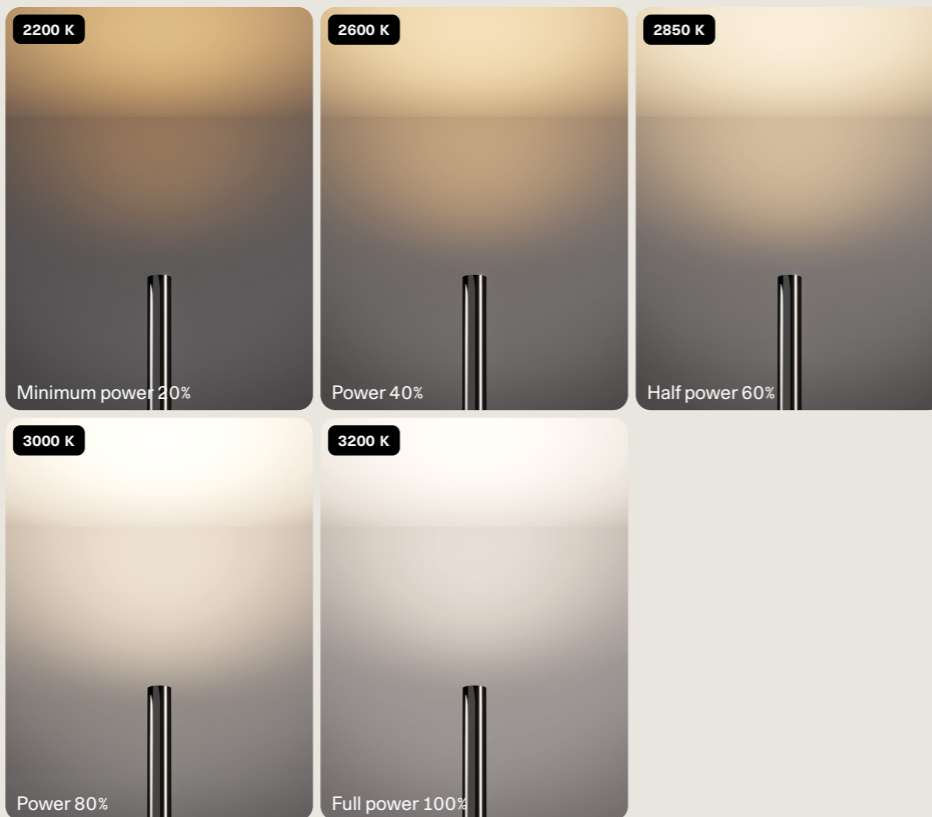

▶ \* Available while stocks last.

▶ \* Disponibile fino ad esaurimento scorte.

Flar medium

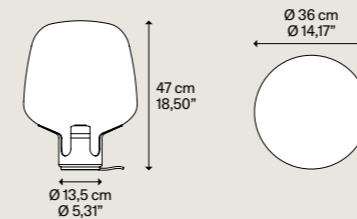

Net weight	6,77 kg	Pack	2
Peso netto	14,92 lbs	Colli	

Flar large

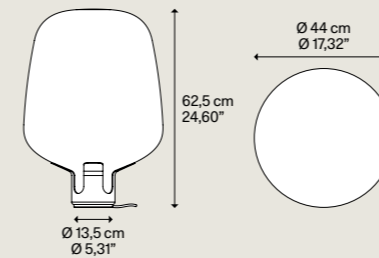

Net weight	9,89 kg	Pack	2
Peso netto	21,80 lbs	Colli	

Metal structure Montatura in metallo	Blown glass diffuser Diffusore in vetro soffiato	Code Codice	Euro €
Matte Champagne Champagne Opaco	Honey Miele	19182 6800	930,00
Matte Champagne Champagne Opaco	Turquoise Turchese	19182 8600	930,00
Terra Terra	Honey Miele	19183 6800	1.050,00
Terra Terra	Turquoise Turchese	19183 8600	1.050,00

Light source  
Sorgente luminosa

E27 T30 W/L max 22,5 cm  
Tubular LED W/L max 8,85"  
1 x 6 W (max 25 W)

Bulb not included  
Dimmer on the cord included

Light bulb to be ordered separately  
Lampadina da ordinare separatamente



Metal structure Montatura in metallo	Blown glass diffuser Diffusore in vetro soffiato	Code Codice	Euro €
Matte Champagne Champagne Opaco	Honey Miele	19184 6800	1.280,00
Matte Champagne Champagne Opaco	Turquoise Turchese	19184 8600	1.280,00
Terra Terra	Honey Miele	19185 6800	1.400,00
Terra Terra	Turquoise Turchese	19185 8600	1.400,00

Light source  
Sorgente luminosa

E27 T30 W/L max 30 cm  
Tubular LED W/L max 11,81"  
1 x 7 W (max 25 W)

Bulb not included  
Dimmer on the cord included

Light bulb to be ordered separately  
Lampadina da ordinare separatamente



Light source Sorgente luminosa		Bulb dimension Dimensione lampadina	Lamp Lampada	Pack Colli	Code Codice	Euro €
E27 T30 6 W	2500 K 620 lm	W/L 22,5 cm W/L 8,85"	Flar medium	1	191A02	35,00
E27 T30 7 W	2500 K 800 lm	W/L 30 cm W/L 11,81"	Flar large	1	191A03	40,00

CATEGORY FLOOR LAMP

Hover

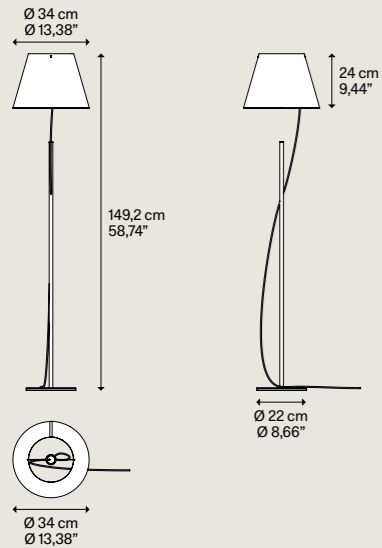

Net weight 3,86 kg / 8,51 lbs  
Pack Colli 2  
Energy class Classe energetica C

DESIGN YOY, 2022

VAT excluded IVA esclusa

Metal structure Montatura in metallo	Paper diffuser Diffusore in carta	Code Codice	Euro €
Matte White Bianco Opaco	Matte White Bianco Opaco	18471 1027	495,00

Light source  
Sorgente luminosa

LED  
2700 K  
6,5 W  
1000 lm  
5 V  
2 A  
CRI 90  
MacAdam 3-Step

LED, driver and touch dimmer included  
LED, driver e touch dimmer inclusi

USB adaptor included  
Adattatore USB incluso

CE IP20 E 5V EAC

CATEGORY TABLE LAMP

Hover

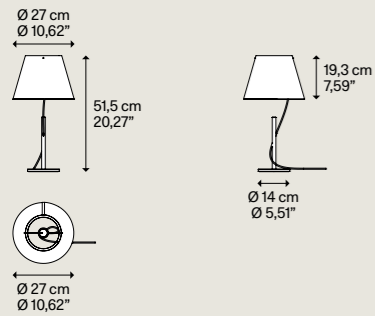

Net weight 1,68 kg / 3,70 lbs  
Pack Colli 2  
Energy class Classe energetica C

DESIGN YOY, 2022

VAT excluded IVA esclusa

Metal structure Montatura in metallo	Paper diffuser Diffusore in carta	Code Codice	Euro €
Matte White Bianco Opaco	Matte White Bianco Opaco	18480 1027	403,00

Light source  
Sorgente luminosa

LED  
2700 K  
6,5 W  
1000 lm  
5 V  
2 A  
CRI 90  
MacAdam 3-Step

LED, driver and touch dimmer included  
LED, driver e touch dimmer inclusi

USB adaptor included  
Adattatore USB incluso

CE IP20 E 5V EAC

CATEGORY TABLE LAMP

Blow

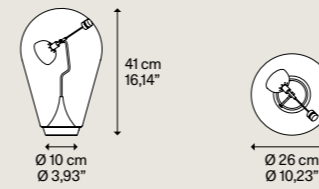

Net weight 4,00 kg / 8,82 lbs  
Pack Colli 1  
Energy class Classe energetica C

DESIGN Pio & Tito Toso, 2005

VAT excluded IVA esclusa

Metal structure Montatura in metallo	Blown glass diffuser Diffusore in vetro soffiato	Code Codice	Euro €
Chrome Cromo	Clear Trasparente	00880 27	1.100,00

Light source  
Sorgente luminosa

LED  
2700 K  
4,5 W  
500 lm  
500 mA  
CRI 90  
MacAdam 3-Step

LED and driver included  
LED e driver inclusi

CE IP20 E TRIAC 220-240V EAC

Adjustable light  
Luce orientabile

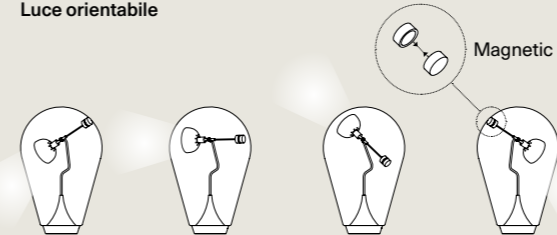

TOUCH DIMMER

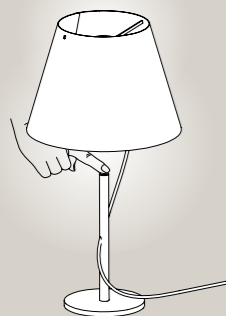

Hover, switch on and off and dim the light intensity.

CABLE



Hover, the lamp shade is connected seamlessly by a single cable that runs through the stem and comes out of the other end.

USB ADAPTOR



### Cono di Luce

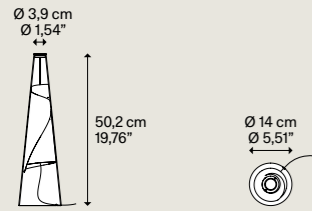

#### Outside blown glass diffuser Diffusore esterno in vetro soffiato

Clear  
Trasparente

#### Light source Sorgente luminosa

LED  
2700 K  
7,5 W  
1307 lm  
5 V - 1,5 A  
CRI 90  
MacAdam 3-Step

LED, driver and touch dimmer included  
LED, driver e touch dimmer inclusi

#### Inside PCB diffuser Diffusore interno in PCB

Grey  
Grigio

Gold  
Oro

Red  
Rosso

Code  
Codice

21080 3227 530,00

21080 5027 581,00

21080 6027 530,00

Net weight 0,91 kg / 2,00 lbs  
Pack Colli 2  
Energy class Classe energetica B



### Easy Peasy

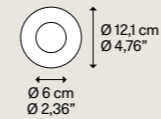
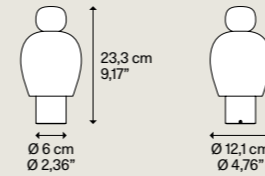

#### Light source Sorgente luminosa

LED  
Dim-to-Warm  
FROM 2200 K  
TO 2700 K  
5 W  
380 lm  
1800 mA Battery  
CRI 90  
MacAdam 3-Step

LED and battery included  
LED e batteria inclusi

Net weight 0,85 kg / 1,87 lbs  
Pack Colli 1  
Energy class Classe energetica D

#### Battery charging time Tempo di ricarica

Power supply  
1A ▶ 180 min

#### Battery life Durata batteria

Full power 100% ▶ 6h  
Half power 50% ▶ 10h  
Min power 10% ▶ 19h



### Easy Peasy

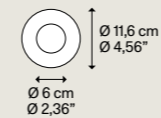
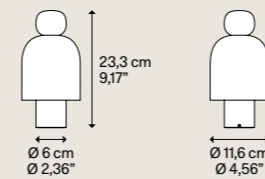

#### Light source Sorgente luminosa

LED  
Dim-to-Warm  
FROM 2200 K  
TO 2700 K  
5 W  
380 lm  
1800 mA Battery  
CRI 90  
MacAdam 3-Step

LED and battery included  
LED e batteria inclusi

Net weight 0,85 kg / 1,87 lbs  
Pack Colli 1  
Energy class Classe energetica D

#### Battery charging time Tempo di ricarica

Power supply  
1A ▶ 180 min

#### Battery life Durata batteria

Full power 100% ▶ 6h  
Half power 50% ▶ 10h  
Min power 10% ▶ 19h



### Flamingo

#### Technopolymer knob Pomolo in tecnopolimero

Pink  
Rosa

#### Blown glass shade Cappello in vetro soffiato

Grey  
Grigio

#### Metal base Base in metallo

Brushed Bronze  
Bronzo Spazzolato

Code  
Codice

17081 6226 266,00

### Lagoon

#### Technopolymer knob Pomolo in tecnopolimero

Turquoise  
Turchese

#### Blown glass shade Cappello in vetro soffiato

Honey  
Miele

#### Metal base Base in metallo

Brushed Gold  
Oro Spazzolato

Code  
Codice

17081 8126 266,00

### Kelp

#### Technopolymer knob Pomolo in tecnopolimero

Green  
Verde

#### Blown glass shade Cappello in vetro soffiato

Honey  
Miele

#### Metal base Base in metallo

Brushed Rose Gold  
Oro Rosa Spazzolato

Code  
Codice

17081 7226 266,00

### Chestnut

#### Technopolymer knob Pomolo in tecnopolimero

Taupe  
Grigio Caldo

#### Blown glass shade Cappello in vetro soffiato

Grey  
Grigio

#### Metal base Base in metallo

Brushed Palladium  
Palladio Spazzolato

Code  
Codice

17081 3826 266,00

### Volum 14

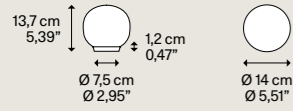

Net weight	0,80 kg	Pack	2
Peso netto	1,76 lbs	Colli	

VAT excluded  
IVA esclusa

#### Silicone base Base in silicone

● Translucent  
Traslucido

#### Blown glass diffuser Diffusore in vetro soffiato

■ Glossy White  
Bianco Lucido

Code  
Codice

18781 1200

Euro €  
174,00

#### Light source Sorgente luminosa

**E14 LED T18**    Ø max 6 cm  
**1 × 5 W**        Ø max 2,36"  
**(max 10 W)**    W/L max 9 cm  
                         W/L max 3,54"

Light bulb to be ordered separately  
Lampadina da ordinare separatamente

ON/OFF Switch the cord  
Interuttore ON/OFF sul cavo



VAT excluded  
IVA esclusa

### Volum 22

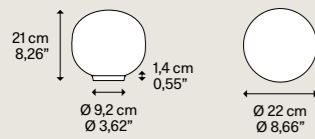

Net weight	1,26 kg	Pack	2
Peso netto	2,77 lbs	Colli	

#### Silicone base Base in silicone

● Translucent  
Traslucido

#### Blown glass diffuser Diffusore in vetro soffiato

■ Glossy White  
Bianco Lucido

Code  
Codice

18782 1200

Euro €  
266,00

#### Light source Sorgente luminosa

**E27 LED T28**    Ø max 6 cm  
**1 × 10 W**        Ø max 2,36"  
**(max 25 W)**    W/L max 12,5 cm  
                         W/L max 4,92"

Light bulb to be ordered separately  
Lampadina da ordinare separatamente

ON/OFF Switch the cord  
Interuttore ON/OFF sul cavo



VAT excluded  
IVA esclusa

### Volum 29

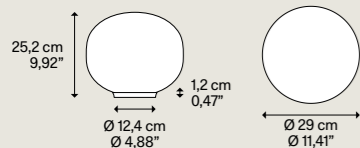

Net weight	2,16 kg	Pack	2
Peso netto	4,76 lbs	Colli	

#### Silicone base Base in silicone

● Translucent  
Traslucido

#### Blown glass diffuser Diffusore in vetro soffiato

■ Glossy White  
Bianco Lucido

Code  
Codice

18783 1200

Euro €  
327,00

#### Light source Sorgente luminosa

**E27 LED T35**    Ø max 9,8 cm  
**1 × 13 W**        Ø max 3,85"  
**(max 25 W)**

Light bulb to be ordered separately  
Lampadina da ordinare separatamente

ON/OFF Switch the cord  
Interuttore ON/OFF sul cavo



VAT excluded  
IVA esclusa

### Volum 42

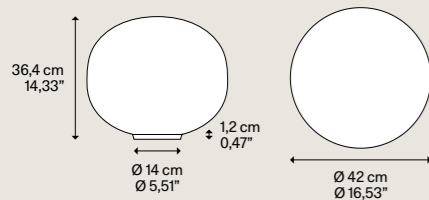

Net weight	3,44 kg	Pack	2
Peso netto	7,58 lbs	Colli	

#### Silicone base Base in silicone

● Translucent  
Traslucido

#### Blown glass diffuser Diffusore in vetro soffiato

■ Glossy White  
Bianco Lucido

Code  
Codice

18784 1200

Euro €  
490,00

#### Light source Sorgente luminosa

**E27 LED T35**    Ø max 9,8 cm  
**1 × 21 W**        Ø max 3,85"  
**(max 25 W)**

Light bulb to be ordered separately  
Lampadina da ordinare separatamente

ON/OFF Switch the cord  
Interuttore ON/OFF sul cavo



VAT excluded  
IVA esclusa

### Volum 14

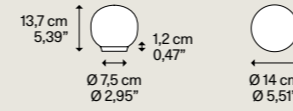

Net weight	0,80 kg	Pack	2
Peso netto	1,76 lbs	Colli	

VAT excluded  
IVA esclusa

#### Silicone base Base in silicone

● Translucent  
Traslucido

#### Blown glass diffuser Diffusore in vetro soffiato

■ Glossy White  
Bianco Lucido

Code  
Codice

18781 120D

Euro €  
245,00

#### Light source Sorgente luminosa

**E14 LED T18**    Ø max 6 cm  
**1 × 5 W**        Ø max 2,36"  
**(max 10 W)**    W/L max 9 cm  
                         W/L max 3,54"

Light bulb to be ordered separately  
Lampadina da ordinare separatamente

Dimmer switch on the cord  
Interuttore con dimmer sul cavo



VAT excluded  
IVA esclusa

### Volum 22

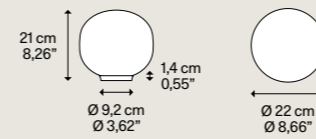

Net weight	1,26 kg	Pack	2
Peso netto	2,77 lbs	Colli	

#### Silicone base Base in silicone

● Translucent  
Traslucido

#### Blown glass diffuser Diffusore in vetro soffiato

■ Glossy White  
Bianco Lucido

Code  
Codice

18782 120D

Euro €  
337,00

#### Light source Sorgente luminosa

**E27 LED T28**    Ø max 6 cm  
**1 × 10 W**        Ø max 2,36"  
**(max 25 W)**    W/L max 12,5 cm  
                         W/L max 4,92"

Light bulb to be ordered separately  
Lampadina da ordinare separatamente

Dimmer switch on the cord  
Interuttore con dimmer sul cavo



VAT excluded  
IVA esclusa

### Volum 29

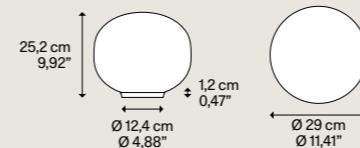

Net weight	2,16 kg	Pack	2
Peso netto	4,76 lbs	Colli	

#### Silicone base Base in silicone

● Translucent  
Traslucido

#### Blown glass diffuser Diffusore in vetro soffiato

■ Glossy White  
Bianco Lucido

Code  
Codice

18783 120D

Euro €  
398,00

#### Light source Sorgente luminosa

**E27 LED T35**    Ø max 9,8 cm  
**1 × 13 W**        Ø max 3,85"  
**(max 25 W)**

Light bulb to be ordered separately  
Lampadina da ordinare separatamente

Dimmer switch on the cord  
Interuttore con dimmer sul cavo



VAT excluded  
IVA esclusa

### Volum 42

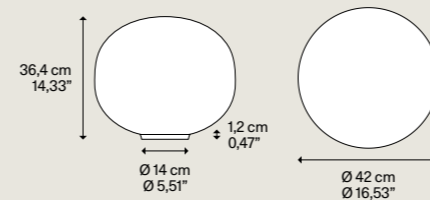

Net weight	3,44 kg	Pack	2
Peso netto	7,58 lbs	Colli	

#### Silicone base Base in silicone

● Translucent  
Traslucido

#### Blown glass diffuser Diffusore in vetro soffiato

■ Glossy White  
Bianco Lucido

Code  
Codice

18784 120D

Euro €  
561,00

#### Light source Sorgente luminosa

**E27 LED T35**    Ø max 9,8 cm  
**1 × 21 W**        Ø max 3,85"  
**(max 25 W)**

Light bulb to be ordered separately  
Lampadina da ordinare separatamente

ON/OFF Switch the cord  
Interuttore ON/OFF sul cavo



VAT excluded  
IVA esclusa

Volum short 29

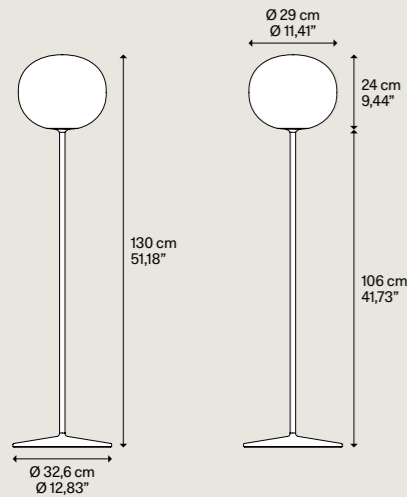

Net weight 8,33 kg  
Peso netto 18,36 lbs  
Pack Colli 2

Metal structure  
Montatura in metallo

White  
Bianco

Blown glass diffuser  
Diffusore in vetro soffiato

Glossy White  
Bianco Lucido

Code  
Codice

18771 1200

Euro €  
595,00

Light source  
Sorgente luminosa

E27 LED T28 1x 10 W (max 25 W)  
Ø max 6 cm  
Ø max 2,36"  
W/L max 12,5 cm  
W/L max 4,92"

Light bulb to be ordered separately  
Lampadina da ordinare separatamente

Dimmer switch on the cord  
Interuttore con dimmer sul cavo



Volum long 29

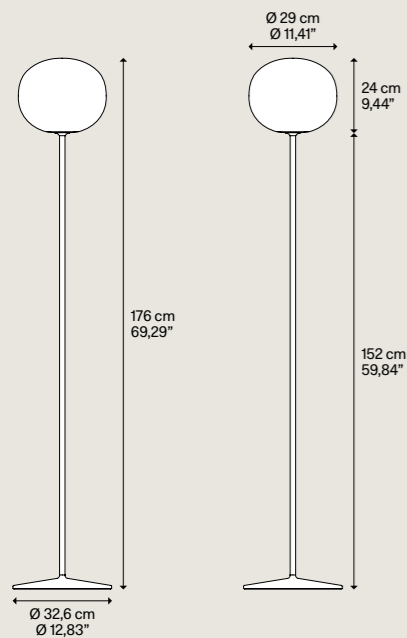

Net weight 8,67 kg  
Peso netto 19,11 lbs  
Pack Colli 2

Metal structure  
Montatura in metallo

White  
Bianco

Blown glass diffuser  
Diffusore in vetro soffiato

Glossy White  
Bianco Lucido

Code  
Codice

18773 1200

Euro €  
680,00

Light source  
Sorgente luminosa

E27 LED T28 1x 10 W (max 25 W)  
Ø max 6 cm  
Ø max 2,36"  
W/L max 12,5 cm  
W/L max 4,92"

Light bulb to be ordered separately  
Lampadina da ordinare separatamente

Dimmer switch on the cord  
Interuttore con dimmer sul cavo



Volum short 42

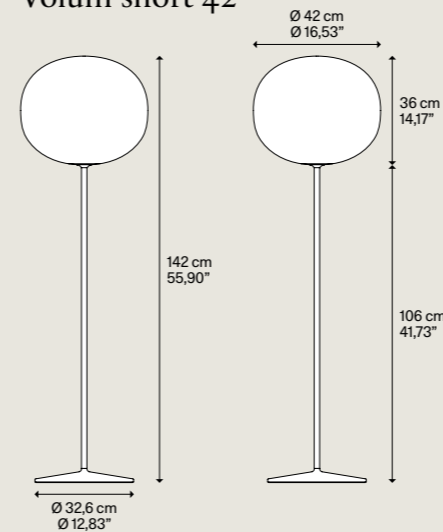

Net weight 9,53 kg  
Peso netto 21,01 lbs  
Pack Colli 2

Metal structure  
Montatura in metallo

White  
Bianco

Blown glass diffuser  
Diffusore in vetro soffiato

Glossy White  
Bianco Lucido

Code  
Codice

18772 1200

Euro €  
711,00

Light source  
Sorgente luminosa

E27 LED T35 1x 21 W (max 25 W)  
Ø max 9,8 cm  
Ø max 3,85"

Light bulb to be ordered separately  
Lampadina da ordinare separatamente

Dimmer switch on the cord  
Interuttore con dimmer sul cavo

Light source  
Sorgente luminosa



Volum long 42

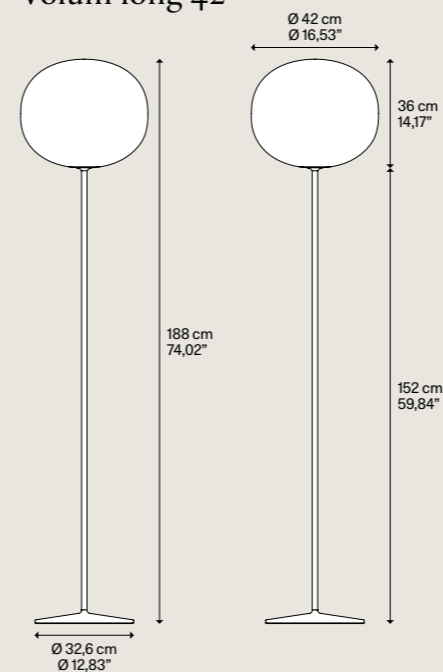

Net weight 9,87 kg  
Peso netto 21,75 lbs  
Pack Colli 2

Metal structure  
Montatura in metallo

White  
Bianco

Blown glass diffuser  
Diffusore in vetro soffiato

Glossy White  
Bianco Lucido

Code  
Codice

18774 1200

Euro €  
796,00

Light source  
Sorgente luminosa

E27 LED T35 1x 21 W (max 25 W)  
Ø max 9,8 cm  
Ø max 3,85"

Light bulb to be ordered separately  
Lampadina da ordinare separatamente

Dimmer switch on the cord  
Interuttore con dimmer sul cavo



Light source  
Sorgente luminosa

E14 LED T18 5 W	2700 K 500 lm	CRI 90 MacAdam 3-Step
E27 LED T28 10 W	2700 K 1000 lm	CRI 90 MacAdam 3-Step
E27 LED T35 13 W	2700 K 1500 lm	CRI 90 MacAdam 3-Step
E27 LED T35 21 W	2700 K 2010 lm	CRI 90 MacAdam 3-Step

Dimmable bulbs/Lampadine dimmerabili

Bulb dimension  
Dimensione lampadina

Ø 1,8 cm Ø 0,70"	W/L 6,1 cm W/L 2,40"
Ø 2,8 cm Ø 1,10"	W/L 11,3 cm W/L 4,44"
Ø 3,5 cm Ø 1,37"	W/L 15 cm W/L 5,90"
Ø 3,5 cm Ø 1,37"	W/L 15 cm W/L 5,90"

Lamp  
Lampada

Volum 14 P. 098, 099
Volum 22, Volum short and long 29 P. 098, 099, 100
Volum 29 P. 098, 099
Volum 42, Volum short and long 42 P. 098, 099, 101

Pack  
Colli

1
1
1
1

Code  
Codice

LAM-0017
LAM-0014
LAM-0015
LAM-0016

Euro €

25,00
30,00
40,00
48,00

# Lodes Lighting Systems

## DOUBLEZERO7 Track System **NEW**

SURFACE

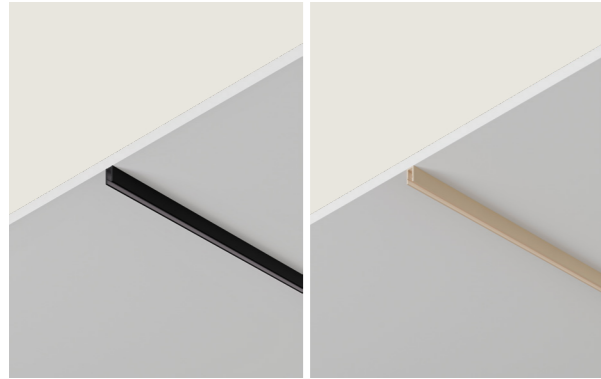

TRIMLESS RECESSED

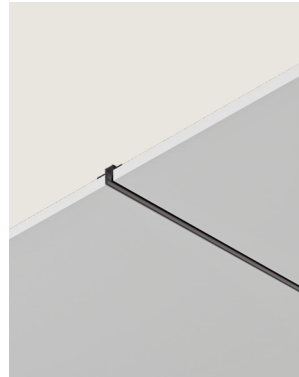

SUSPENDED UP&DOWN

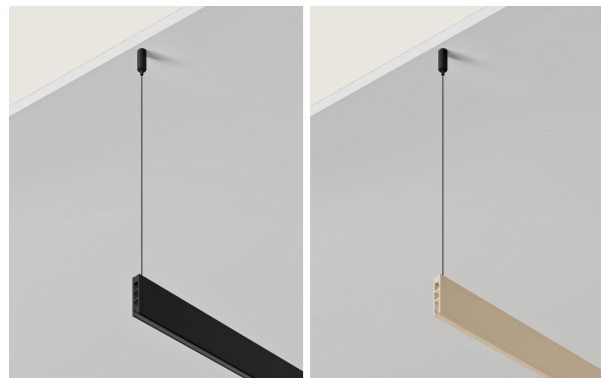

## DOUBLEZERO7 007 TRACK SYSTEM

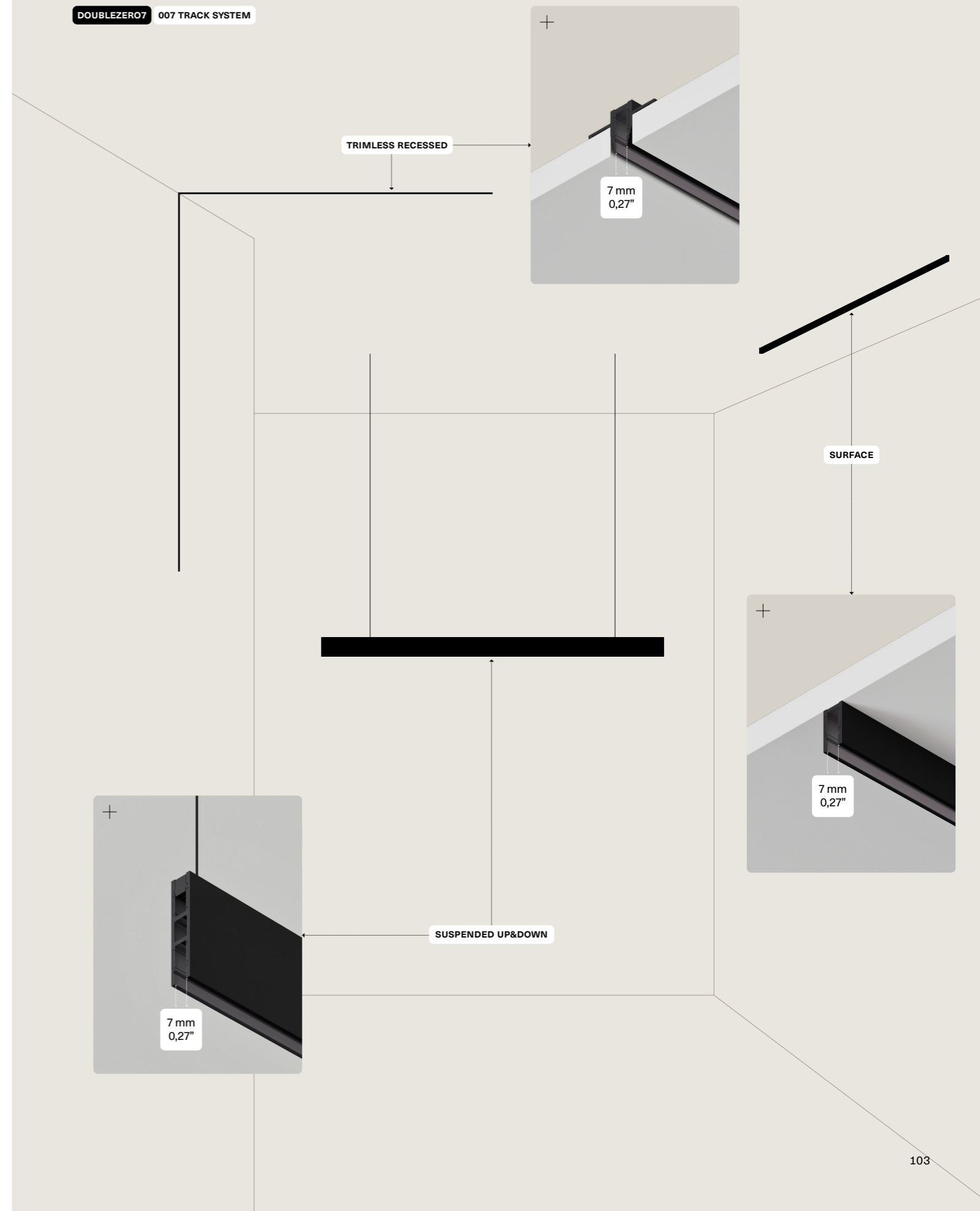

Surface Profile

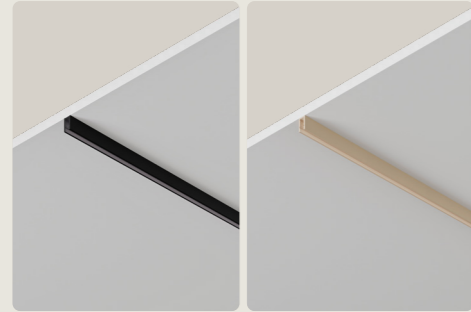

Description Descrizione	Metal structure Montatura in metallo	Track length Lunghezza binario	Code Codice	Euro €
48V track profile for surface mounting, available in three lengths. Aesthetic finishing cover included.	● Extra Matte Black Nero Extra Opaco	A 1 m - 39,37"	T07A100 20	60,00
	● Extra Matte Champagne Champagne Extra Opaco		T07A100 45	70,00
Profilo a binario 48V per installazione a superficie, disponibile in tre lunghezze. Cover esteticadi finitura inclusa.	● Extra Matte Black Nero Extra Opaco	B 2 m - 78,74"	T07A200 20	120,00
	● Extra Matte Champagne Champagne Extra Opaco		T07A200 45	140,00
	● Extra Matte Black Nero Extra Opaco		T07A300 20	180,00
	● Extra Matte Champagne Champagne Extra Opaco	C 3 m - 118,11"	T07A300 45	210,00

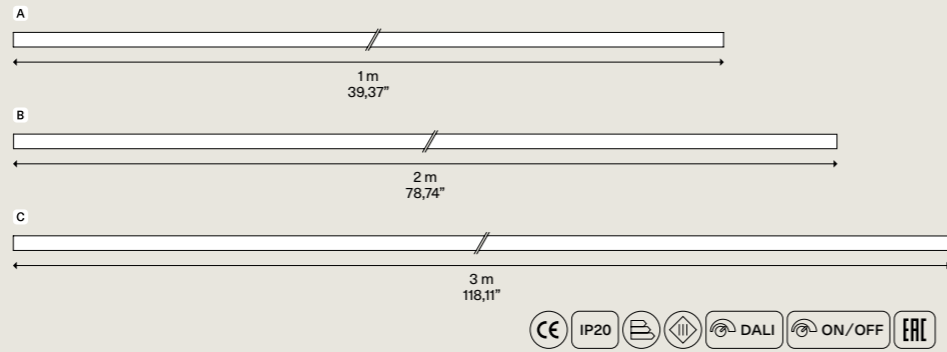
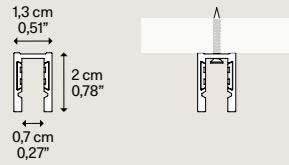

Net weight 280 g/m<sup>2</sup> / 0,61 lbs/m<sup>2</sup> | Pack Colli 1



VAT excluded IVA esclusa

Surface 90° Curve

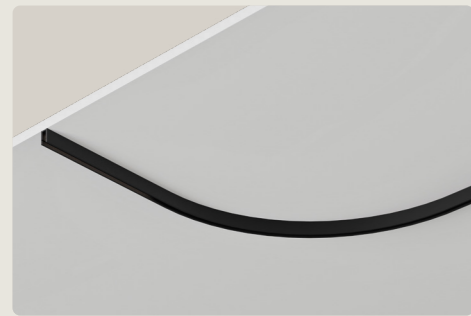

Description Descrizione	Metal structure Montatura in metallo	Track curvature Curvatura binario	Code Codice	Euro €
90° curved element - 30 cm / 11,81" radius for the Surface track, for creating curves on the same installation plane. Aesthetic finishing cover included.	● Extra Matte Black Nero Extra Opaco	D 90° R30	T07AR30 20	180,00
	● Extra Matte Champagne Champagne Extra Opaco		T07AR30 45	190,00

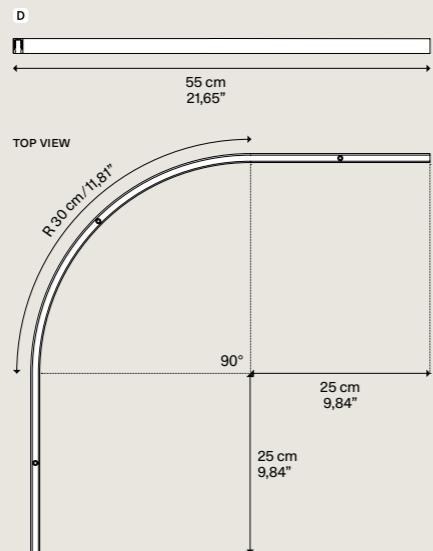

Net weight 210 g / 0,46 lbs | Pack Colli 1



Flat Corner

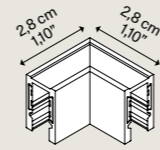

Net weight 10 g / 0,02 lbs | Pack Colli 1

Description Descrizione	Metal structure Montatura in metallo	Corner Angolo	Code Codice	Euro €
90° corner element for connecting two Surface track sections on the same plane.	● Extra Matte Black Nero Extra Opaco	IN-PLANE	T07AF90 20	25,00
	● Extra Matte Champagne Champagne Extra Opaco		T07AF90 45	35,00

VAT excluded IVA esclusa



Internal Corner

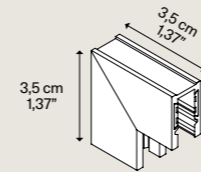

Net weight 10 g / 0,02 lbs | Pack Colli 1

Description Descrizione	Metal structure Montatura in metallo	Corner Angolo	Code Codice	Euro €
Internal 90° corner element for connecting two Surface track sections around an inside angle.	● Extra Matte Black Nero Extra Opaco	INTERNAL	T07AI90 20	25,00
	● Extra Matte Champagne Champagne Extra Opaco		T07AI90 45	35,00

VAT excluded IVA esclusa



External Corner

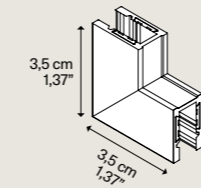

Net weight 10 g / 0,02 lbs | Pack Colli 1

Description Descrizione	Metal structure Montatura in metallo	Corner Angolo	Code Codice	Euro €
External 90° corner element for connecting two Surface track sections around an outside angle.	● Extra Matte Black Nero Extra Opaco	EXTERNAL	T07AE90 20	25,00
	● Extra Matte Champagne Champagne Extra Opaco		T07AE90 45	35,00

VAT excluded IVA esclusa



End Cap (x2)

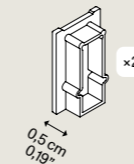

Net weight 5 g / 0,01 lbs | Pack Colli 1

Description Descrizione	Metal structure Montatura in metallo	Code Codice	Euro €
End caps (x2) for closing the end of the Surface track.	● Extra Matte Black Nero Extra Opaco	T07AC01 20	5,00
Elementi di chiusura (x2) per terminare l'estremità del binario Surface.	● Extra Matte Champagne Champagne Extra Opaco	T07AC01 45	8,00

VAT excluded IVA esclusa



### Joint Connector

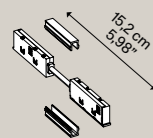

Net weight	0,15 g	Pack	1
Peso netto	0,03 lbs	Colli	

Description Descrizione	Metal structure Montatura in metallo	Code Codice	Euro €
Electrical connector ensuring power continuity between two track sections, suitable for both linear connections and corner elements.	● Extra Matte Black Nero Extra Opaco	T07J001	40,00

Connettore elettrico per garantire la continuità dell'alimentazione tra due segmenti di binario, sia in connessioni lineari che negli elementi angolari.



VAT excluded  
IVA esclusa

### Driver Box End Feed

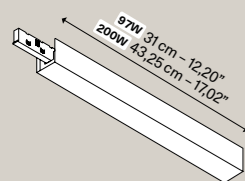

Net weight	97W	600 g	Pack	1
Peso netto		1,32 lbs	Colli	
	200W	750 g		
		1,65 lbs		

Description Descrizione	Metal structure Montatura in metallo	Power Potenza	Code Codice	Euro €
Box with integrated 48V ON/OFF driver, featuring a single side end-feed connector for powering the track from one end.	● Extra Matte Black Nero Extra Opaco	96 w	T07AD01 2000	160,00
	● Extra Matte Champagne Champagne Extra Opaco		T07AD01 4500	170,00
Box con driver 48V ON/OFF integrato, dotato di connettore end-feed laterale per alimentare il binario da un'estremità.	● Extra Matte Black Nero Extra Opaco	200 w	T07AD02 2000	200,00
	● Extra Matte Champagne Champagne Extra Opaco		T07AD02 4500	210,00

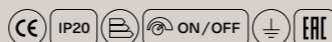

VAT excluded  
IVA esclusa

### Driver Box Central Feed

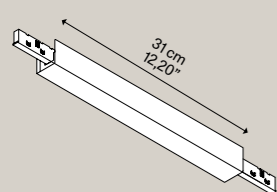

Net weight	600 g	Pack	1
Peso netto	1,32 lbs	Colli	

Description Descrizione	Metal structure Montatura in metallo	Power Potenza	Code Codice	Euro €
48V ON/OFF driver box with dual side connectors for powering the track from a central point in both directions.	● Extra Matte Black Nero Extra Opaco	96 w	T07AD03 2000	200,00
	● Extra Matte Champagne Champagne Extra Opaco		T07AD03 4500	210,00

Box con driver 48V ON/OFF integrato, con doppio connettore laterale per alimentare il binario da un punto centrale in entrambe le direzioni.



VAT excluded  
IVA esclusa

### 48V ON/OFF Driver for Remote installation

Net weight	97W	160 g	Pack	1
Peso netto		0,35 lbs	Colli	
	200W	320 g		
		0,70 lbs		

Description Descrizione	Metal structure Montatura in metallo	Power Potenza	Code Codice	Euro €
48V ON/OFF driver for remote installation, powering the track up to a total load of 96W or 200W.	● Extra Matte Black Nero Extra Opaco	96 w	T07ED01 00	99,00
	● Extra Matte Black Nero Extra Opaco	200 w	T07ED02 00	150,00

Driver 48V ON/OFF per installazione remota, che alimenta il binario fino a un carico totale di 96W o 200W.

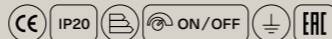

VAT excluded  
IVA esclusa

### Feed Connector for Remote-Driver installation

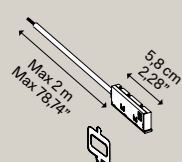

Net weight	100 g	Pack	1
Peso netto	0,22 lbs	Colli	

Description Descrizione	Metal structure Montatura in metallo	Code Codice	Euro €
Electrical connector for powering the track from one end in remote-driver installations and for connecting a DALI BUS. Includes an installation key for the Trimless Recessed profile.	● Extra Matte Black Nero Extra Opaco	T07J002	30,00

Connettore elettrico per alimentare il binario da un'estremità nelle installazioni con driver remoto e per collegare un bus DALI. Include una chiave di installazione per il profilo Trimless Recessed.



### Trimless Recessed Profile

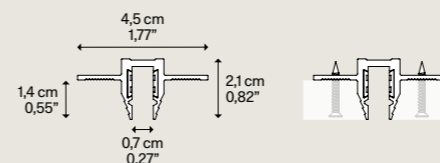
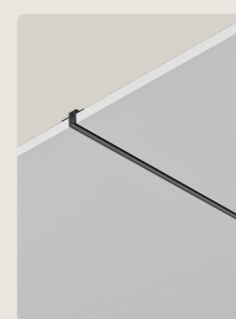

Net weight	500 g/m <sup>2</sup>	Pack	1
Peso netto	1,10 lbs/m <sup>2</sup>	Colli	

### Trimless Recessed 90° Curve

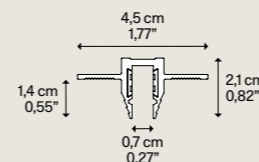

Net weight	375 g	Pack	1
Peso netto	0,82 lbs	Colli	

Description Descrizione	Metal structure Montatura in metallo	Track length Lunghezza binario	Code Codice	Euro €
48V trimless recessed track profile, available in three lengths. Aesthetic finishing cover included. Protective cover and aesthetic finishing cover included.	● Extra Matte Black Nero Extra Opaco	A 1 m - 39,37"	T07E100 20	60,00
	● Extra Matte Black Nero Extra Opaco	B 2 m - 78,74"	T07E200 20	120,00
	● Extra Matte Black Nero Extra Opaco	C 3 m - 118,11"	T07E300 20	180,00

Profilo a binario 48V per installazione ad incasso trimless, disponibile in tre lunghezze. Cover protettiva e cover estetica di finitura incluse.

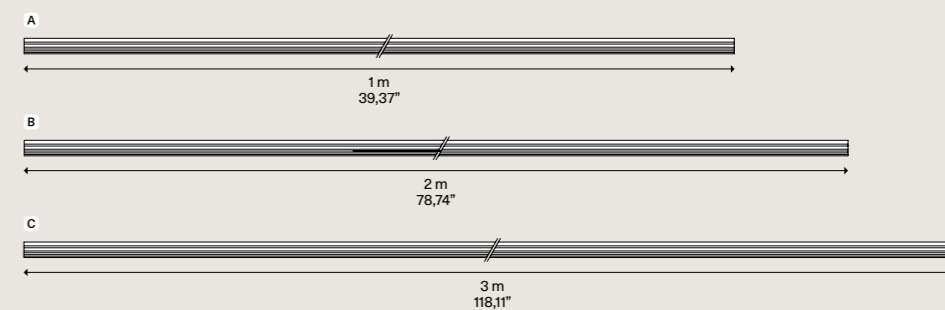

VAT excluded  
IVA esclusa

Description Descrizione	Metal structure Montatura in metallo	Track curvature Curvatura binario	Code Codice	Euro €
90° curved element - 30 cm / 11,81" radius for the Trimless Recessed track, for creating curves on the same installation plane. Protective cover and aesthetic finishing cover included.	● Extra Matte Black Nero Extra Opaco	D 90° R30	T07ER30 20	250,00

Elemento curvo a 90° - raggio 30 cm / 11,81" per il binario Trimless Recessed, per realizzare curve sullo stesso piano di installazione. Cover protettiva e cover estetica di finitura incluse.

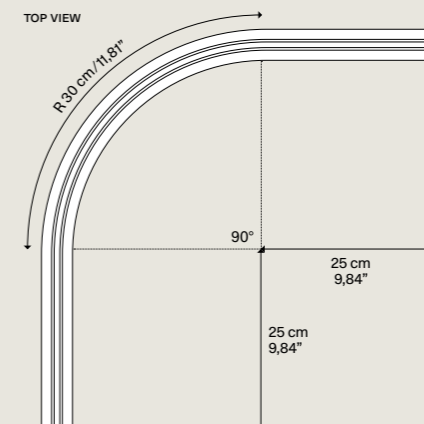
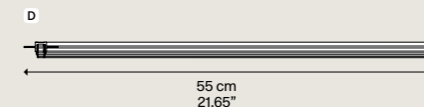

### Flat Corner

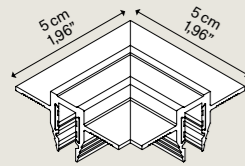

Net weight 20 g / 0,04 lbs  
Pack Colli 1

**Description**  
Descrizione

90° corner element for connecting two Trimless Recessed track sections on the same plane.

Elemento angolare a 90° per collegare due segmenti di binario Trimless Recessed sullo stesso piano.

Metal structure Montatura in metallo	Corner Angolo	Code Codice	Euro €
● Extra Matte Black Nero Extra Opaco	<b>IN-PLANE</b>	T07EF90 20	32,00



VAT excluded IVA esclusa

### Internal Corner

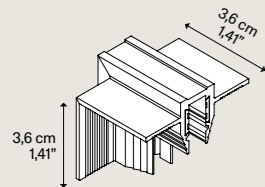

Net weight 20 g / 0,04 lbs  
Pack Colli 1

**Description**  
Descrizione

Internal 90° corner element for connecting two Trimless Recessed track sections around an inside angle.

Elemento angolare interno a 90° per collegare due segmenti di binario Trimless Recessed in un angolo rientrante.

Metal structure Montatura in metallo	Corner Angolo	Code Codice	Euro €
● Extra Matte Black Nero Extra Opaco	<b>INTERNAL</b>	T07EI90 20	32,00



VAT excluded IVA esclusa

### External Corner

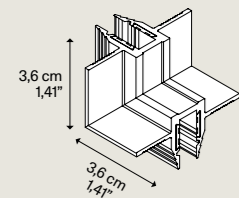

Net weight 20 g / 0,04 lbs  
Pack Colli 1

**Description**  
Descrizione

External 90° corner element for connecting two Trimless Recessed track sections around an outside angle.

Elemento angolare esterno a 90° per collegare due segmenti di binario Trimless Recessed in un angolo sporgente.

Metal structure Montatura in metallo	Corner Angolo	Code Codice	Euro €
● Extra Matte Black Nero Extra Opaco	<b>EXTERNAL</b>	T07EE90 20	32,00



### Joint Connector

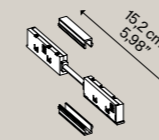

Net weight 0,15 g / 0,03 lbs  
Pack Colli 1

**Description**  
Descrizione

Electrical connector ensuring power continuity between two track sections, suitable for both linear connections and corner elements.

Metal structure Montatura in metallo	Code Codice	Euro €
● Extra Matte Black Nero Extra Opaco	T07J001	40,00



VAT excluded IVA esclusa

### 48V ON/OFF Driver for Remote installation

Net weight Peso netto	97W 160 g / 0,35 lbs	200W 320 g / 0,70 lbs	Pack Colli	1
--------------------------	-------------------------	--------------------------	------------	---

**Description**  
Descrizione

48V ON/OFF driver for remote installation, powering the track up to a total load of 96W or 200W.

Driver 48V ON/OFF per installazione remota, che alimenta il binario fino a un carico totale di 96W o 200W.

Metal structure Montatura in metallo	Power Potenza	Code Codice	Euro €
● Extra Matte Black Nero Extra Opaco	<b>96 w</b>	T07ED01 00	99,00
● Extra Matte Black Nero Extra Opaco	<b>200 w</b>	T07ED02 00	150,00



VAT excluded IVA esclusa

### Feed Connector for Remote-Driver installation

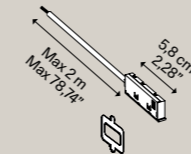

Net weight 100 g / 0,22 lbs  
Pack Colli 1

**Description**  
Descrizione

Electrical connector for powering the track from one end in remote-driver installations and for connecting a DALI BUS. Includes an installation key for the Trimless Recessed profile.

Metal structure Montatura in metallo	Code Codice	Euro €
● Extra Matte Black Nero Extra Opaco	T07J002	30,00



## Suspended UP&DOWN Profile

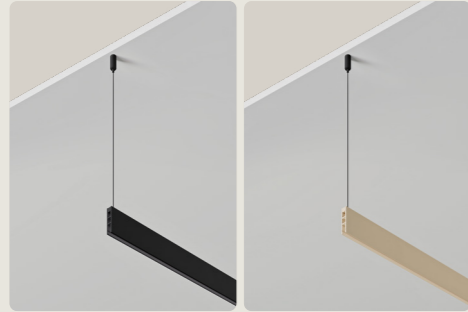

Description Descrizione	Metal structure Montatura in metallo	Track length Lunghezza binario	Code Codice	Euro €
48V suspended track profile with dual emission (UP & DOWN), available in two lengths. Aesthetic finishing cover included.  Profilo a binario 48V sospeso a doppia emissione (UP & DOWN), disponibile in due lunghezze. Cover estetica di finitura inclusa.	● Extra Matte Black Nero Extra Opaco	A 2 m - 78,74"	T07H200 20	290,00
	● Extra Matte Champagne Champagne Extra Opaco		T07H200 45	370,00
	● Extra Matte Black Nero Extra Opaco	C 3 m - 118,11"	T07H300 20	440,00
	● Extra Matte Champagne Champagne Extra Opaco		T07H300 45	560,00

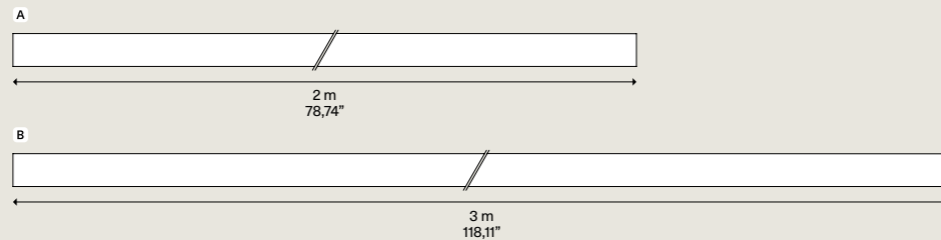
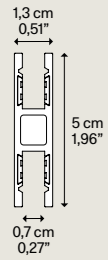

Net weight 650 g/m<sup>2</sup>  
Peso netto 1,43 lbs/m<sup>2</sup> Pack Colli 1



## Suspension Kit (x2)

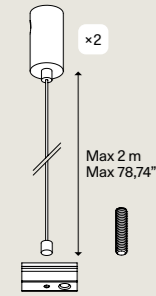

Description Descrizione	Metal structure Montatura in metallo	Code Codice	Euro €
Suspension Kit (x2) - max 2 m - 78,74"	● Extra Matte Black Nero Extra Opaco	T07HK01 20	24,00
Suspension Kit (x2) - max 2 m - 78,74"			

Net weight 50 g  
Peso netto 0,11 lbs Pack Colli 1



## End Cap (x2)

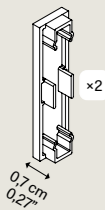

Description Descrizione	Metal structure Montatura in metallo	Code Codice	Euro €
End caps (x2) for closing the end of the Suspended track.	● Extra Matte Black Nero Extra Opaco	T07HC01 20	7,00
Elementi di chiusura (x2) per terminare l'estremità del binario Suspended.	● Extra Matte Champagne Champagne Extra Opaco	T07HC01 45	10,00

Net weight 8 g  
Peso netto 0,01 lbs Pack Colli 1



## Joint Connector

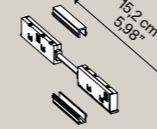

Net weight 0,15 g  
Peso netto 0,03 lbs Pack Colli 1

Description Descrizione	Metal structure Montatura in metallo	Code Codice	Euro €
Electrical connector ensuring power continuity between two track sections, suitable for both linear connections and corner elements.  Connettore elettrico per garantire la continuità dell'alimentazione tra due segmenti di binario, sia in connessioni lineari che negli elementi angolari.	● Extra Matte Black Nero Extra Opaco	T07J001	40,00



## Driver Box - Suspended

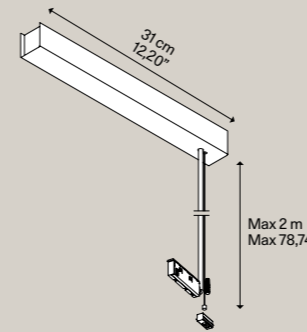

Net weight 800 g  
Peso netto 1,76 lbs Pack Colli 1

Description Descrizione	Metal structure Montatura in metallo	Power Potenza	Code Codice	Euro €
Box with integrated 48V ON/OFF driver, featuring a 2 m power cable with an End Feed Connector for supplying power to the suspended track from above.  Box con driver 48V ON/OFF integrato, dotato di un cavo di alimentazione da 2 m con Connettore End Feed per alimentare il binario sospeso dalla parte superiore.	● Extra Matte Black Nero Extra Opaco	96 w	T07HD01 2000	180,00
	● Extra Matte Champagne Champagne Extra Opaco		T07HD01 4500	190,00



## 48V ON/OFF Driver for Remote installation

Net weight 97W 160 g  
Peso netto 0,35 lbs Pack Colli 1  
200W 320 g  
0,70 lbs

Description Descrizione	Metal structure Montatura in metallo	Power Potenza	Code Codice	Euro €
48V ON/OFF driver for remote installation, powering the track up to a total load of 96W or 200W.  Driver 48V ON/OFF per installazione remota, che alimenta il binario fino a un carico totale di 96W o 200W.	● Extra Matte Black Nero Extra Opaco	96 w	T07ED01 00	99,00
	● Extra Matte Black Nero Extra Opaco	200 w	T07ED02 00	150,00

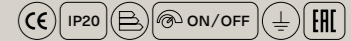

## Feed Connector for Remote-Driver installation

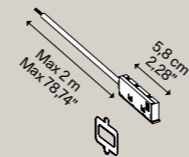

Net weight 100 g  
Peso netto 0,22 lbs Pack Colli 1

Description Descrizione	Metal structure Montatura in metallo	Code Codice	Euro €
Electrical connector for powering the track from one end in remote-driver installations and for connecting a DALI BUS. Includes an installation key for the Trimless Recessed profile.  Connettore elettrico per alimentare il binario da un'estremità nelle installazioni con driver remoto e per collegare un bus DALI. Include una chiave di installazione per il profilo Trimless Recessed.	● Extra Matte Black Nero Extra Opaco	T07J002	30,00



# DOUBLEZERO7 Surface

<b>A</b> Surface Profile	P. 104
<b>B</b> Surface 90° Curve	P. 104
<b>1</b> End Cap	P. 105
<b>2</b> Joint Connector	P. 106
<b>3</b> Flat Corner	P. 105
<b>4</b> Internal Corner	P. 105
<b>5</b> Driver Box End Feed	P. 106
<b>6</b> Driver Box Central Feed	P. 106
<b>7</b> 48V ON/OFF Driver	P. 106
<b>8</b> Feed Connector	P. 106



Easy Cut

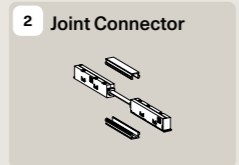

**2** Joint Connector

DOUBLEZERO7 SURFACE

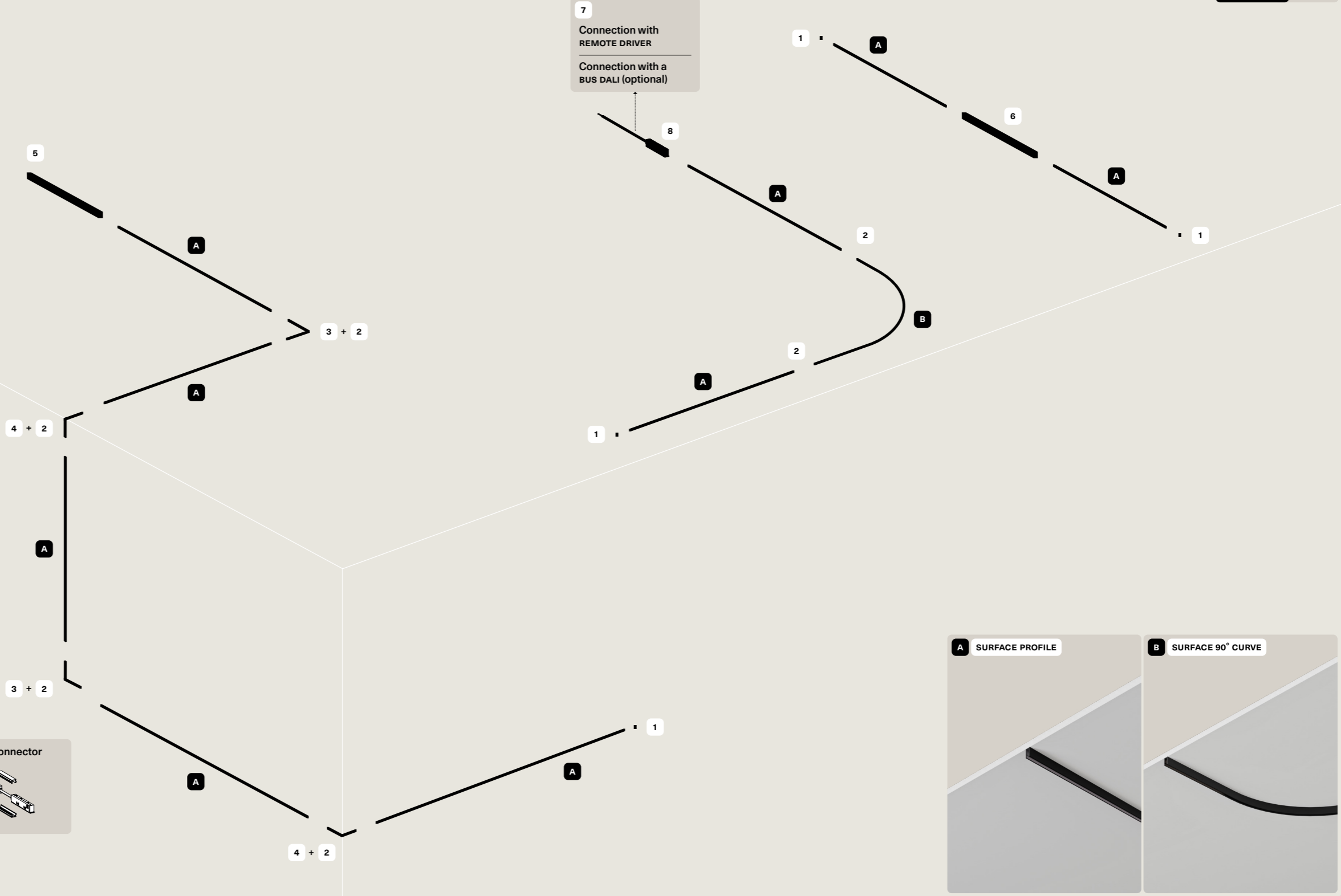

SUSPENSION LAMP  
CLUSTER SUSPENSION LAMP  
CANOPY  
WALL & CEILING LAMP  
FLOOR & TABLE LAMP  
SYSTEM  
ACCESSORY

# DOUBLEZERO7 Trimless Recessed

<b>A</b>	Trimless Recessed Profile	P. 107
<b>B</b>	Trimless Recessed 90° Curve	P. 107
<b>1</b>	Joint Connector	P. 109
<b>2</b>	Flat Corner	P. 108
<b>3</b>	Internal Corner	P. 108
<b>4</b>	48V ON/OFF Driver	P. 109
<b>5</b>	Feed Connector	P. 109

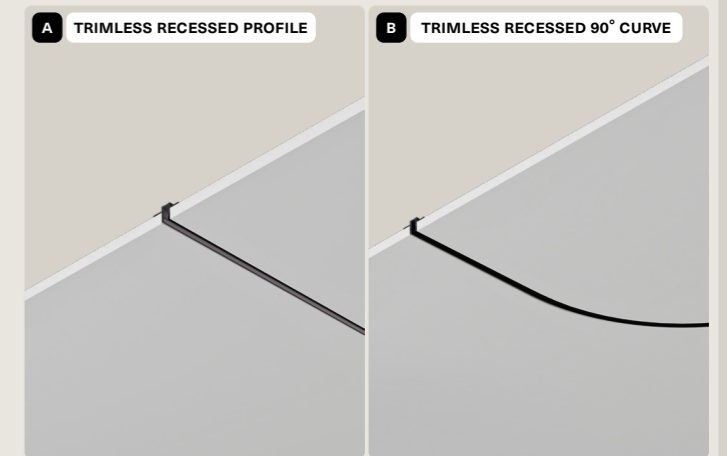
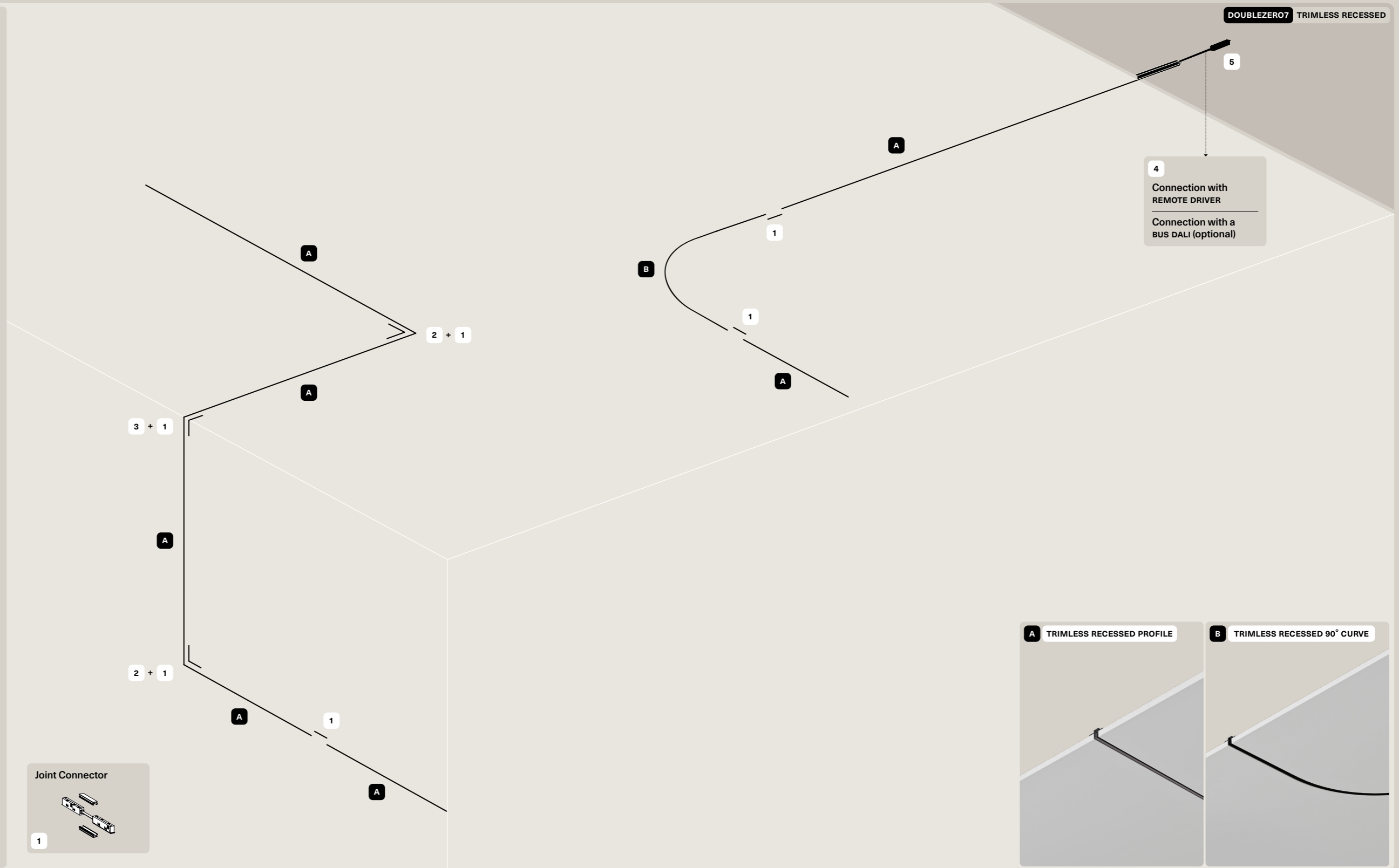
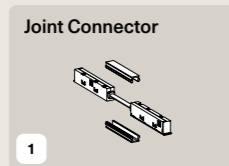

SUSPENSION LAMP  
CLUSTER SUSPENSION LAMP  
CANOPY  
WALL & CEILING LAMP  
FLOOR & TABLE LAMP  
SYSTEM  
ACCESSORY

# DOUBLEZERO7

## Suspended UP&DOWN

<b>A</b>	Suspended UP&DOWN Profile	P. 110
<b>1</b>	End Cap	P. 110
<b>2</b>	Suspension Kit	P. 110
<b>3</b>	Joint Connector	P. 111
<b>4</b>	Driver Box - Suspended	P. 111
<b>5</b>	48V ON/OFF Driver	P. 111
<b>6</b>	Feed Connector	P. 111

### Up&Down Emission Doppia Emissione

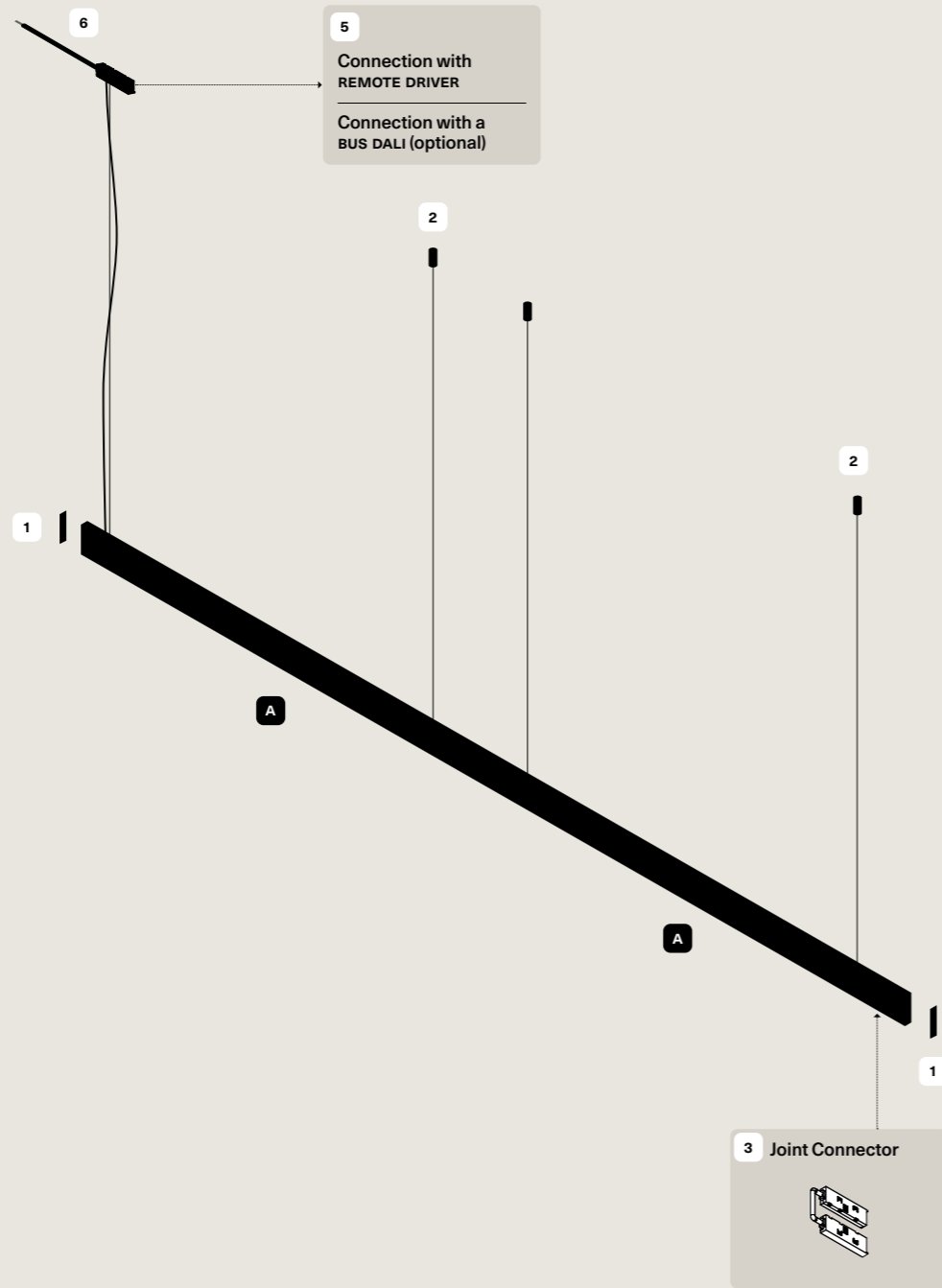

### Mono (Down) Emission Mono Emissione

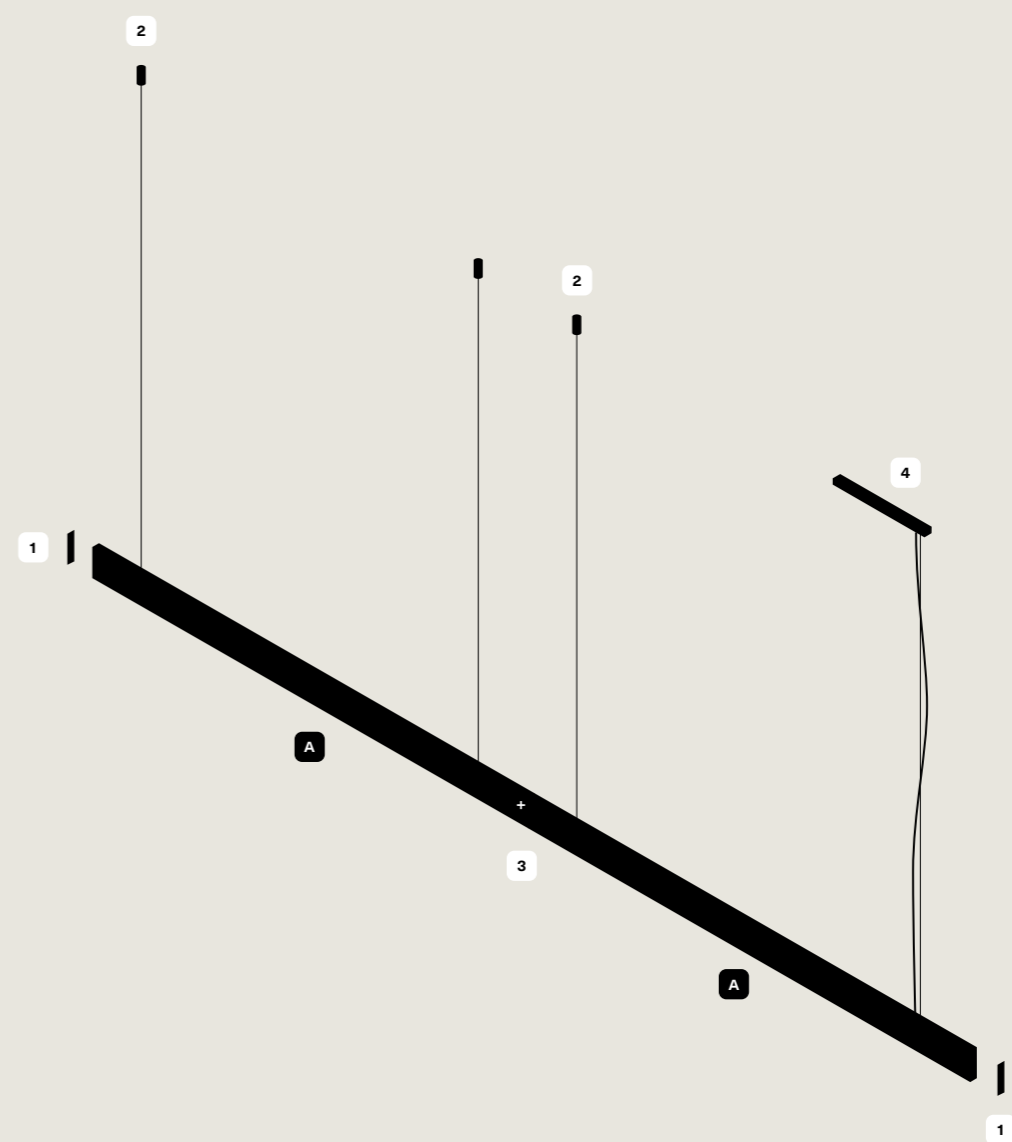

DOUBLEZERO7 SUSPENDED UP&DOWN

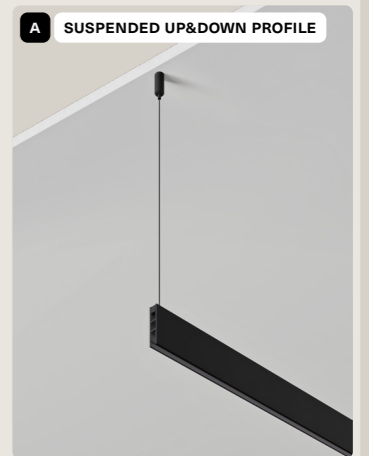

# Lodes Lighting Systems

## DOUBLEZERO7 Track Light Modules **NEW**

### CLUSTER CLIP



### Bambi SPOTLIGHT



### Solitaire WALLWASHER



### Camille GENERAL LIGHT



### Severine LIGHT LINE

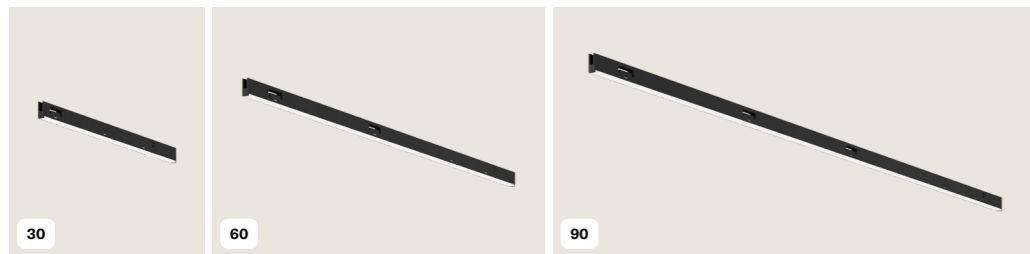

CATEGORY 007 TRACK LIGHT MODULES **NEW**

DESIGN Lodes, 2026

**DOUBLEZERO7** VAT excluded IVA esclusa

## Cluster Clip



### Description Descrizione

Adapter with integrated clip for connecting and installing Lodes Cluster pendants on the track. Compatible lamps are shown in the dedicated section below.

Adattatore con clip integrata per collegare e installare le sospensioni Cluster di Lodes sul binario. Le lampade compatibili sono riportate nella sezione dedicata sotto.

### Metal structure Montatura in metallo

- Extra Matte Black Nero Extra Opaco
- Extra Matte Champagne Champagne Extra Opaco
- Extra Matte Black Nero Extra Opaco
- Extra Matte Champagne Champagne Extra Opaco

### Type of dimming Dimmerazione

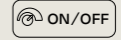

### Code Codice

T07001 20	95,00
T07001 45	100,00
T07101 20	55,00
T07101 45	60,00

### Euro €

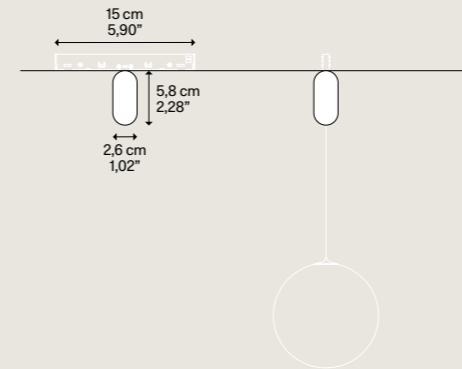

Net weight 65 g / 0,14 lbs | Pack Colli 1



## Lodes lamps suitable for DOUBLEZERO7



\* Volum cluster suspension on the DOUBLEZERO7 system must use the following bulbs, which have to be ordered separately.   
 Volum sospensione cluster sul sistema DOUBLEZERO7 deve necessariamente utilizzare le seguenti lampadine, da ordinare separatamente.

VAT excluded IVA esclusa

Light source Sorgente luminosa	Lamp Lampada	System Sistema	Pack Colli	Code Codice	Euro €
E14 5,1 W  2700 K 570 lm CRI 90 MacAdam 3-Step	Volum 14 P. 059	<b>DOUBLEZERO7</b>	1	LAM-0033	28,00
E27 9,1 W  2700 K 960 lm CRI 90 MacAdam 3-Step	Volum 22 P. 059		1	LAM-0034	33,00

### Bambi 26 SPOTLIGHT

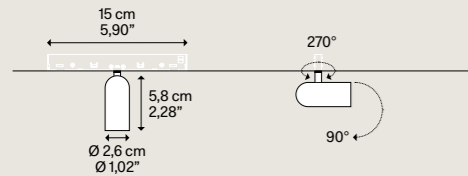

Metal structure Montatura in metallo
● Extra Matte Black Nero Extra Opaco
● Extra Matte Champagne Champagne Extra Opaco
● Extra Matte Black Nero Extra Opaco
● Extra Matte Champagne Champagne Extra Opaco

Type of dimming Dimmerazione
Ⓜ DALI
Ⓜ ON/OFF

Code Codice	A	Code Codice	B	Euro €
T07061 2027		T07061 2030		195,00
T07061 4527		T07061 4530		210,00
T07161 2027		T07161 2030		140,00
T07161 4527		T07161 4530		155,00

**Description**  
Descrizione

Compact 48V spotlight for the DOUBLEZERO7 track system.

Proiettore compatto a 48V per installazione su binario DOUBLEZERO7.

**Optics**  
Ottica

The product is supplied with three interchangeable optics and an integrated honeycomb louvre.

Il prodotto viene fornito con tre ottiche intercambiabili e filtro honeycomb inclusi.

Light source Sorgente luminosa		A	Light source Sorgente luminosa		B
LED	2700	K	LED	3000	K
	4	W		4	W
	512	lm		528	lm
	CRI 90			CRI 90	
	MacAdam 3-Step			MacAdam 3-Step	



Net weight 60 g  
Peso netto 0,13 lbs  
Pack Colli 1



### Bambi 35 SPOTLIGHT

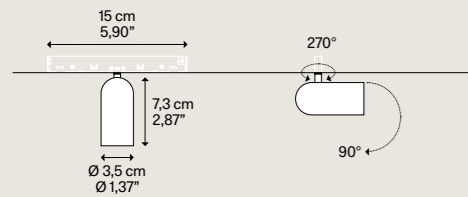

Metal structure Montatura in metallo
● Extra Matte Black Nero Extra Opaco
● Extra Matte Champagne Champagne Extra Opaco
● Extra Matte Black Nero Extra Opaco
● Extra Matte Champagne Champagne Extra Opaco

Type of dimming Dimmerazione
Ⓜ DALI
Ⓜ ON/OFF

Code Codice	A	Code Codice	B	Euro €
T07062 2027		T07062 2030		215,00
T07062 4527		T07062 4530		235,00
T07162 2027		T07162 2030		160,00
T07162 4527		T07162 4530		180,00

**Description**  
Descrizione

Compact 48V spotlight for the DOUBLEZERO7 track system.

Proiettore compatto a 48V per installazione su binario DOUBLEZERO7.

**Optics**  
Ottica

The product is supplied with three interchangeable optics and an integrated honeycomb louvre.

Il prodotto viene fornito con tre ottiche intercambiabili e filtro honeycomb inclusi.

Light source Sorgente luminosa		A	Light source Sorgente luminosa		B
LED	2700	K	LED	3000	K
	8	W		8	W
	768	lm		792	lm
	CRI 90			CRI 90	
	MacAdam 3-Step			MacAdam 3-Step	

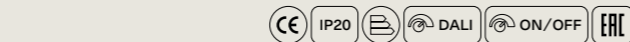

Net weight 120 g  
Peso netto 0,26 lbs  
Pack Colli 1



### Bambi 45 SPOTLIGHT

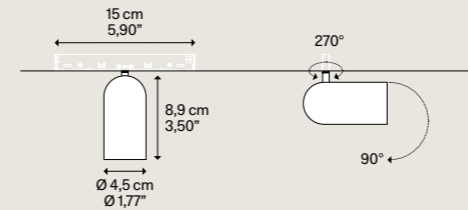

Metal structure Montatura in metallo
● Extra Matte Black Nero Extra Opaco
● Extra Matte Champagne Champagne Extra Opaco
● Extra Matte Black Nero Extra Opaco
● Extra Matte Champagne Champagne Extra Opaco

Type of dimming Dimmerazione
Ⓜ DALI
Ⓜ ON/OFF

Code Codice	A	Code Codice	B	Euro €
T07063 2027		T07063 2030		240,00
T07063 4527		T07063 4530		260,00
T07163 2027		T07163 2030		185,00
T07163 4527		T07163 4530		205,00

**Description**  
Descrizione

Compact 48V spotlight for the DOUBLEZERO7 track system.

Proiettore compatto a 48V per installazione su binario DOUBLEZERO7.

**Optics**  
Ottica

The product is supplied with three interchangeable optics and an integrated honeycomb louvre.

Il prodotto viene fornito con tre ottiche intercambiabili e filtro honeycomb inclusi.

Light source Sorgente luminosa		A	Light source Sorgente luminosa		B
LED	2700	K	LED	3000	K
	12	W		12	W
	1340	lm		1390	lm
	CRI 90			CRI 90	
	MacAdam 3-Step			MacAdam 3-Step	

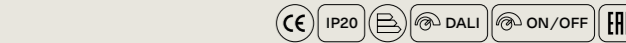

Net weight 220 g  
Peso netto 0,48 lbs  
Pack Colli 1



### Solitaire WALLWASHER

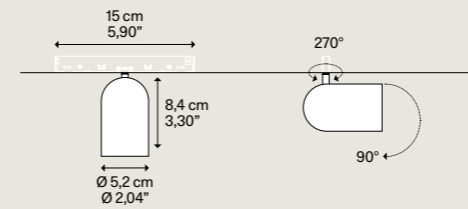

Metal structure Montatura in metallo
● Extra Matte Black Nero Extra Opaco
● Extra Matte Champagne Champagne Extra Opaco
● Extra Matte Black Nero Extra Opaco
● Extra Matte Champagne Champagne Extra Opaco

Type of dimming Dimmerazione
Ⓜ DALI
Ⓜ ON/OFF

Code Codice	A	Code Codice	B	Euro €
T07051 2027		T07051 2030		240,00
T07051 4527		T07051 4530		260,00
T07151 2027		T07151 2030		185,00
T07151 4527		T07151 4530		205,00

**Description**  
Descrizione

Compact 48V wallwasher spotlight for installation on the DOUBLEZERO7 track system.

Proiettore compatto wallwasher a 48V per installazione su binario DOUBLEZERO7.

**Optics**  
Ottica

The wallwasher optic is designed to provide uniform illumination of walls and vertical surfaces.

L'ottica wallwasher è progettata per garantire un'illuminazione uniforme di pareti e superfici verticali.

Light source Sorgente luminosa		A	Light source Sorgente luminosa		B
LED	2700	K	LED	3000	K
	10	W		10	W
	1970	lm		2100	lm
	CRI 90			CRI 90	
	MacAdam 3-Step			MacAdam 3-Step	

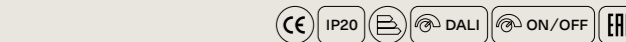

Net weight 260 g  
Peso netto 0,57 lbs  
Pack Colli 1



### Camille GENERAL LIGHT

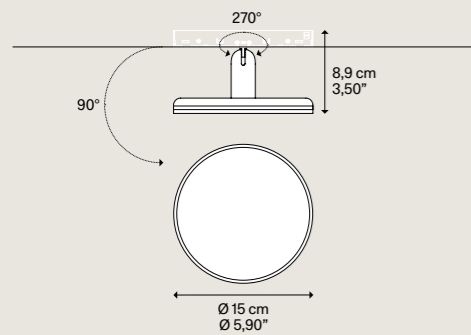

Metal structure Montatura in metallo	Type of dimming Dimmerazione	Code Codice	<b>A</b> Code Codice	<b>B</b> Code Codice	Euro €
● Extra Matte Black Nero Extra Opaco		T07031 2027	T07031 2030		185,00
● Extra Matte Champagne Champagne Extra Opaco		T07031 4527	T07031 4530		195,00
● Extra Matte Black Nero Extra Opaco		T07131 2027	T07131 2030		140,00
● Extra Matte Champagne Champagne Extra Opaco		T07131 4527	T07131 4530		150,00

**Description**  
Descrizione

Adjustable 48V general light module with microprismatic diffuser for the DOUBLEZERO7 track system.

Modulo orientabile a luce diffusa 48V con diffusore microprismatico, per installazione su binario DOUBLEZERO7.

**Beam angle**  
Angolo del fascio

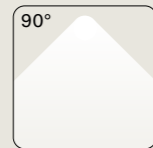

WIDE

Net weight Peso netto	360 g 0,79 lbs	Pack Colli	1
--------------------------	-------------------	---------------	---



VAT excluded  
IVA esclusa

### Severine 30 LIGHT LINE

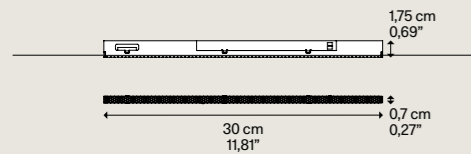

Metal structure Montatura in metallo	Type of dimming Dimmerazione	Code Codice	<b>A</b> Code Codice	<b>B</b> Code Codice	Euro €
● Extra Matte Black Nero Extra Opaco		T07091 27	T07091 30		165,00
● Extra Matte Black Nero Extra Opaco			T07191 27	T07191 30	

**Description**  
Descrizione

48V light line for installation on the DOUBLEZERO7 track system, 30 cm / 11,81" length.

Linea di luce a 48V per installazione su binario DOUBLEZERO7, lunghezza 30 cm / 11,81".

**Beam angle**  
Angolo del fascio



EXTRA WIDE

Net weight Peso netto	60 g 0,13 lbs	Pack Colli	1
--------------------------	------------------	---------------	---



### Severine 60 LIGHT LINE

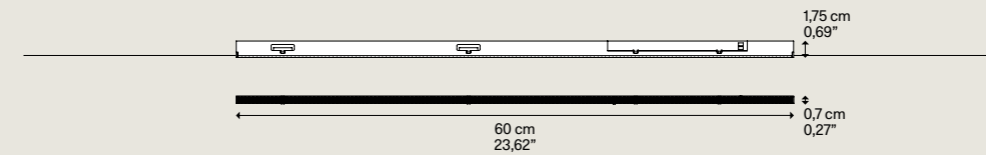

Net weight Peso netto	100 g 0,22 lbs	Pack Colli	1
--------------------------	-------------------	---------------	---



VAT excluded  
IVA esclusa

### Severine 90 LIGHT LINE

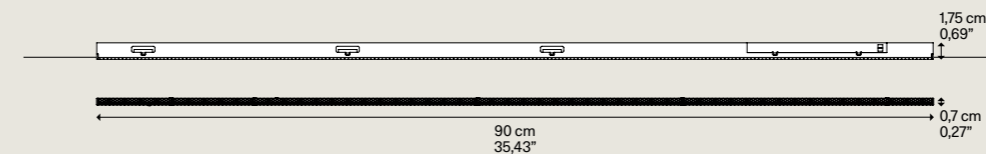

Net weight Peso netto	145 g 0,31 lbs	Pack Colli	1
--------------------------	-------------------	---------------	---



Metal structure Montatura in metallo	Type of dimming Dimmerazione	Code Codice	<b>A</b> Code Codice	<b>B</b> Code Codice	Euro €
● Extra Matte Black Nero Extra Opaco		T07093 27	T07093 30		220,00
● Extra Matte Black Nero Extra Opaco			T07193 27	T07193 30	

**Description**  
Descrizione

48V light line for installation on the DOUBLEZERO7 track system, 90 cm / 35,43" length.

Linea di luce a 48V per installazione su binario DOUBLEZERO7, lunghezza 90 cm / 35,43".

**Beam angle**  
Angolo del fascio

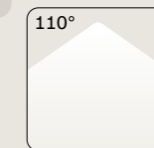

EXTRA WIDE

**Description**  
Descrizione

48V light line for installation on the DOUBLEZERO7 track system, 60 cm / 23,62" length.

Linea di luce a 48V per installazione su binario DOUBLEZERO7, lunghezza 60 cm / 23,62".

**Beam angle**  
Angolo del fascio

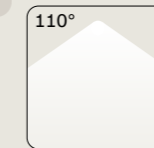

EXTRA WIDE

Light source Sorgente luminosa	
LED 2700 8 1064 CRI 90 MacAdam 3-Step	K W lm

Light source Sorgente luminosa	
LED 3000 8 1088 CRI 90 MacAdam 3-Step	K W lm

# Lodes Lighting Systems

## MAP Track System

MAP Starting and Additional Point



MAP Starting and Additional Point



MAP Connection Point



MAP Tape



MAP Ceiling Bracket

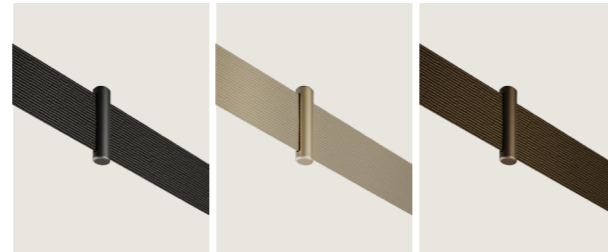

MAP Corner Bracket



CATEGORY CEILING LAMP WALL LAMP

## MAP Starting Point TRIAC

A-B

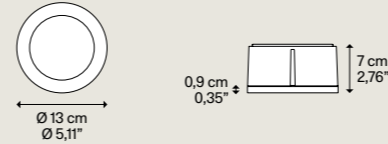

Net weight 0,90 kg 1,98 lbs Pack Colli 3

C

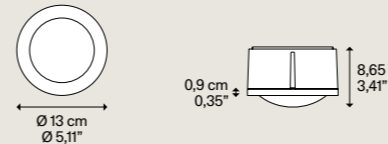

Net weight 1,02 kg 2,24 lbs Pack Colli 2

D

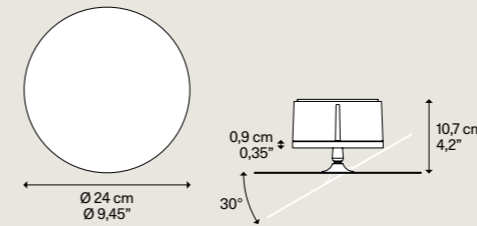

Net weight 1,50 kg 3,30 lbs Pack Colli 2

### Light source Sorgente luminosa

LED	7,5	W
Turnable White	2700 K	→ 900 lm
	3000 K	→ 918 lm
	24 V	
	CRI 90	
	MacAdam 3-Step	

TRIAC driver integrated included Driver TRIAC integrato incluso

## MAP Connection Point

E

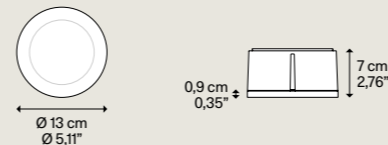

Net weight 0,90 kg 1,98 lbs Pack Colli 1

Energy class Classe energetica C

DESIGN GECKELER MICHELS, 2025

VAT excluded IVA esclusa

Optics or lens Ottica o lente	Metal structure Montatura in metallo	Dimming Dimmer	Code Codice	Euro €
MEDIUM OPTICS 26°	Matte Black - 9005 Nero Opaco - 9005		22731 2023ME	305,00
A MEDIUM OPTICS 26° + HONEYCOMB	Matte Black - 9005 Nero Opaco - 9005		22731 2023MEH	310,00
WIDE OPTICS 55°	Matte Black - 9005 Nero Opaco - 9005		22731 2023EW	305,00
B WIDE OPTICS 55° + HONEYCOMB	Matte Black - 9005 Nero Opaco - 9005		22731 2023EWH	310,00
C LODES LENS 80°	Matte Black - 9005 Nero Opaco - 9005		22731 2023UW	315,00
D INDIRECT LIGHT	Matte Black - 9005 Nero Opaco - 9005		22731 2023IL	365,00
MEDIUM OPTICS 26°	Extra Matte Champagne Champagne Extra Opaco		22731 4523ME	315,00
A MEDIUM OPTICS 26° + HONEYCOMB	Extra Matte Champagne Champagne Extra Opaco		22731 4523MEH	320,00
WIDE OPTICS 55°	Extra Matte Champagne Champagne Extra Opaco		22731 4523EW	315,00
B WIDE OPTICS 55° + HONEYCOMB	Extra Matte Champagne Champagne Extra Opaco	TRIAC	22731 4523EWH	320,00
C LODES LENS 80°	Extra Matte Champagne Champagne Extra Opaco		22731 4523UW	325,00
D INDIRECT LIGHT	Extra Matte Champagne Champagne Extra Opaco		22731 4523IL	375,00
MEDIUM OPTICS 26°	Natural Brown* Testa di Moro		22731 6923ME	315,00
A MEDIUM OPTICS 26° + HONEYCOMB	Natural Brown* Testa di Moro		22731 6923MEH	320,00
WIDE OPTICS 55°	Natural Brown* Testa di Moro		22731 6923EW	315,00
B WIDE OPTICS 55° + HONEYCOMB	Natural Brown* Testa di Moro		22731 6923EWH	320,00
C LODES LENS 80°	Natural Brown* Testa di Moro		22731 6923UW	325,00
D INDIRECT LIGHT	Natural Brown* Testa di Moro		22731 6923IL	375,00

\* NSC S 8005 Y50R

► Up to 4 Additional Points can be connected to a single Starting Point, for a total of 5 luminaires (1x Starting Point TRIAC + max. 4x Additional Points).

► È possibile collegare fino a 4 Additional Points a un unico Starting Point, per un totale di 5 punti luce (1x Starting Point TRIAC + max. 4x Additional Points).

VAT excluded IVA esclusa

Description Descrizione	Metal structure Montatura in metallo	Dimming Dimmer	Code Codice	Euro €
MAP Starting Point blind, without a light source.	Matte Black - 9005 Nero Opaco - 9005		22734 2000	270,00
E MAP Starting Point cieco, privo di sorgente luminosa.	Extra Matte Champagne Champagne Extra Opaco	TRIAC	22734 4500	280,00
	Natural Brown* Testa di Moro		22734 6900	280,00

\* NSC S 8005 Y50R

► Up to 4 Additional Points can be connected to a single Connection Point, for a total of 5 units (1x Connection Point + 4x Additional Points).  
► MAP Connection Point with integrated TRIAC driver.

► È possibile collegare fino a 4 Additional Points a un unico Connection Point, per un totale di 5 elementi (1x Connection Point + 4x Additional Points).  
► MAP Connection Point con driver TRIAC integrato.



## MAP Starting Point DALI

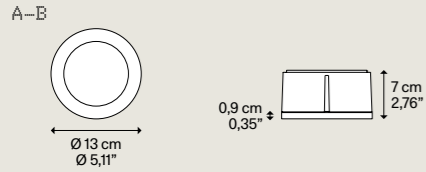

Net weight 1,00 kg / 2,20 lbs  
Pack Colli 4

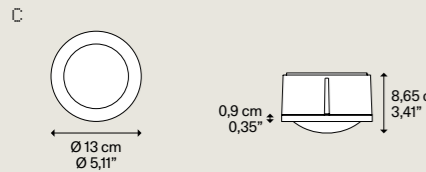

Net weight 1,12 kg / 2,46 lbs  
Pack Colli 3

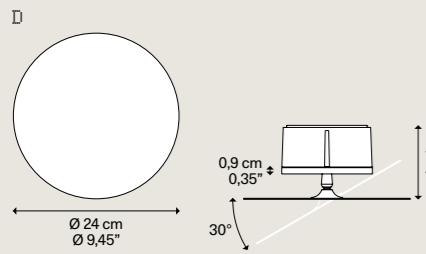

Net weight 1,60 kg / 3,52 lbs  
Pack Colli 3

### Light source Sorgente luminosa

**LED**  
Turnable White

7,5	W
2700 K	→ 900 lm
3000 K	→ 918 lm

24 V  
CRI 90  
MacAdam 3-Step

DALI/PUSH remote driver included\*  
Driver DALI/PUSH remoto incluso\*

Energy class  
Classe energetica **C**

Optics or lens Optica o lente	Metal structure Montatura in metallo	Dimming Dimmer	Code Codice	Euro €
MEDIUM OPTICS 26°	Matte Black - 9005 Nero Opaco - 9005		22733 2023ME	325,00
A MEDIUM OPTICS 26° + HONEYCOMB	Matte Black - 9005 Nero Opaco - 9005		22733 2023MEH	330,00
WIDE OPTICS 55°	Matte Black - 9005 Nero Opaco - 9005		22733 2023EW	325,00
B WIDE OPTICS 55° + HONEYCOMB	Matte Black - 9005 Nero Opaco - 9005		22733 2023EWH	330,00
C LODES LENS 80°	Matte Black - 9005 Nero Opaco - 9005		22733 2023UW	335,00
D INDIRECT LIGHT	Matte Black - 9005 Nero Opaco - 9005		22733 2023IL	385,00
MEDIUM OPTICS 26°	Extra Matte Champagne Champagne Extra Opaco		22733 4523ME	335,00
A MEDIUM OPTICS 26° + HONEYCOMB	Extra Matte Champagne Champagne Extra Opaco		22733 4523MEH	340,00
WIDE OPTICS 55°	Extra Matte Champagne Champagne Extra Opaco		22733 4523EW	335,00
B WIDE OPTICS 55° + HONEYCOMB	Extra Matte Champagne Champagne Extra Opaco		22733 4523EWH	340,00
C LODES LENS 80°	Extra Matte Champagne Champagne Extra Opaco		22733 4523UW	345,00
D INDIRECT LIGHT	Extra Matte Champagne Champagne Extra Opaco		22733 4523IL	395,00
MEDIUM OPTICS 26°	Natural Brown** Testa di Moro		22733 6923ME	335,00
A MEDIUM OPTICS 26° + HONEYCOMB	Natural Brown** Testa di Moro		22733 6923MEH	340,00
WIDE OPTICS 55°	Natural Brown** Testa di Moro		22733 6923EW	335,00
B WIDE OPTICS 55° + HONEYCOMB	Natural Brown** Testa di Moro		22733 6923EWH	340,00
C LODES LENS 80°	Natural Brown** Testa di Moro		22733 6923UW	345,00
D INDIRECT LIGHT	Natural Brown** Testa di Moro		22733 6923IL	395,00

\*\* NSC S 8005 Y50R

► Up to 7 Additional Points can be connected to a single Starting Point, for a total of 8 luminaires (1 × Starting Point DALI + max. 7 × Additional Points).

► È possibile collegare fino a 7 Additional Points a un unico Starting Point, per un totale di 8 punti luce (1 × Starting Point DALI + max. 7 × Additional Points).

## MAP Additional Point

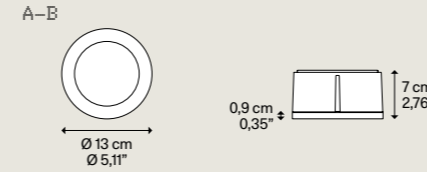

Net weight 0,70 kg / 1,54 lbs  
Pack Colli 3

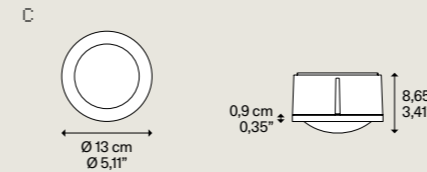

Net weight 0,82 kg / 1,80 lbs  
Pack Colli 2

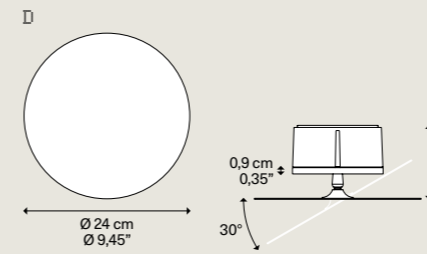

Net weight 1,30 kg / 2,86 lbs  
Pack Colli 2

### Light source Sorgente luminosa

**LED**  
Turnable White

7,5	W
2700 K	→ 900 lm
3000 K	→ 918 lm

24 V  
CRI 90  
MacAdam 3-Step

Energy class  
Classe energetica **C**

Optics or lens Optica o lente	Metal structure Montatura in metallo	Dimming Dimmer	Code Codice	Euro €
MEDIUM OPTICS 26°	Matte Black - 9005 Nero Opaco - 9005		22732 2023ME	205,00
A MEDIUM OPTICS 26° + HONEYCOMB	Matte Black - 9005 Nero Opaco - 9005		22732 2023MEH	210,00
WIDE OPTICS 55°	Matte Black - 9005 Nero Opaco - 9005		22732 2023EW	205,00
B WIDE OPTICS 55° + HONEYCOMB	Matte Black - 9005 Nero Opaco - 9005		22732 2023EWH	210,00
C LODES LENS 80°	Matte Black - 9005 Nero Opaco - 9005		22732 2023UW	215,00
D INDIRECT LIGHT	Matte Black - 9005 Nero Opaco - 9005		22732 2023IL	265,00
MEDIUM OPTICS 26°	Extra Matte Champagne Champagne Extra Opaco		22732 4523ME	215,00
A MEDIUM OPTICS 26° + HONEYCOMB	Extra Matte Champagne Champagne Extra Opaco		22732 4523MEH	220,00
WIDE OPTICS 55°	Extra Matte Champagne Champagne Extra Opaco		22732 4523EW	215,00
B WIDE OPTICS 55° + HONEYCOMB	Extra Matte Champagne Champagne Extra Opaco		22732 4523EWH	220,00
C LODES LENS 80°	Extra Matte Champagne Champagne Extra Opaco		22732 4523UW	225,00
D INDIRECT LIGHT	Extra Matte Champagne Champagne Extra Opaco		22732 4523IL	275,00
MEDIUM OPTICS 26°	Natural Brown** Testa di Moro		22732 6923ME	215,00
A MEDIUM OPTICS 26° + HONEYCOMB	Natural Brown** Testa di Moro		22732 6923MEH	220,00
WIDE OPTICS 55°	Natural Brown** Testa di Moro		22732 6923EW	215,00
B WIDE OPTICS 55° + HONEYCOMB	Natural Brown** Testa di Moro		22732 6923EWH	220,00
C LODES LENS 80°	Natural Brown** Testa di Moro		22732 6923UW	225,00
D INDIRECT LIGHT	Natural Brown** Testa di Moro		22732 6923IL	275,00

\*\* NSC S 8005 Y50R

► MAP Additional Point operates only when connected to a MAP Starting Point (TRIAC or DALI) or a MAP Connection Point via the MAP Tape.

► MAP Additional Point funziona solo se collegato a un MAP Starting Point (TRIAC o DALI) o a un MAP Connection Point tramite la MAP Tape.

\* DALI driver included in the packaging, for remote installation.

\* Driver DALI incluso nella confezione, per installazione remota.

Dimension Dimensione	Power Potenza	Input voltage Tensione di ingresso	Output voltage Tensione di uscita
176×45×32 mm	60 W	110-240V AC	24V DC

DESIGN GECKELER MICHELS, 2025

VAT excluded  
 IVA esclusa

## MAP Tape

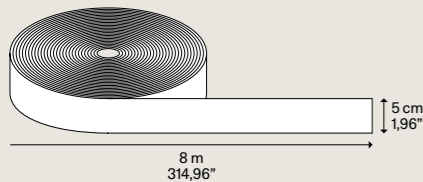

Net weight 0,45 kg  
 Peso netto 0,99 lbs  
 Pack Colli 1

### Description Descrizione

MAP Tape: tape in 8 m reels.  
 MAP Tape: nastro in bobine da 8 m.

### Metal structure Montatura in metallo

	Code Codice	Euro €
● Matte Black Nero Opaco	22701 20	170,00
● Matte Champagne Champagne Opaco	22701 45	175,00
● Natural Brown Testa di Moro	22701 69	175,00

CE IP20

CATEGORY ACCESSORY

## MAP Ceiling Bracket

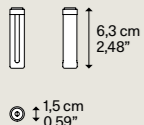

Net weight 0,02 kg  
 Peso netto 0,04 lbs  
 Pack Colli 1

### Description Descrizione

MAP Ceiling Bracket is an accessory to be applied when the tape exceeds 2 metres in length between lighting points. In the case of wall application, the accessory is to be applied when the tape exceeds 1 m in length between lighting points.

MAP Ceiling Bracket è un accessorio da applicare quando il nastro supera i 2 metri di lunghezza tra un punto luce e l'altro. In caso di applicazione a parete, l'accessorio va applicato quando il nastro supera 1 m di lunghezza tra un punto luce e l'altro.

### Metal structure Montatura in metallo

	Code Codice	Euro €
● Matte Black Nero Opaco	22702 20	24,00
● Matte Champagne Champagne Opaco	22702 45	26,00
● Natural Brown Testa di Moro	22702 69	26,00

CE

VAT excluded  
 IVA esclusa

## MAP Corner Bracket

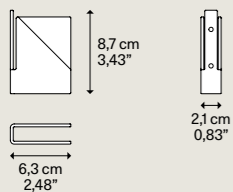

Net weight 0,20 kg  
 Peso netto 0,44 lbs  
 Pack Colli 1

### Description Descrizione

MAP Corner Bracket is the accessory that allows you to create ceiling-to-wall corners while keeping the tape securely in place.

MAP Corner Bracket è l'accessorio che permette di realizzare angoli soffitto-parete mantenendo il nastro saldamente in posizione.

### Metal structure Montatura in metallo

	Code Codice	Euro €
● Matte Black Nero Opaco	22704 20	38,00
● Matte Champagne Champagne Opaco	22704 45	40,00
● Natural Brown Testa di Moro	22704 69	40,00

CE

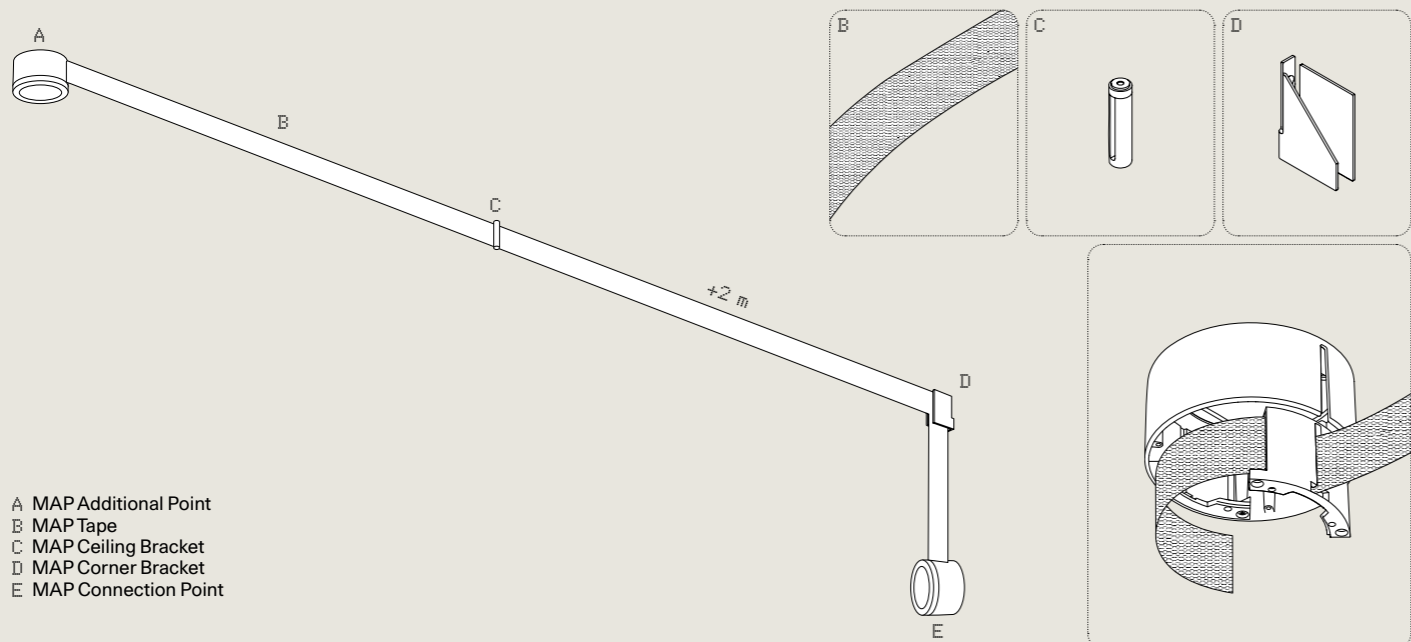

A MAP Additional Point  
 B MAP Tape  
 C MAP Ceiling Bracket  
 D MAP Corner Bracket  
 E MAP Connection Point

# Accessories

## CATEGORY RADIAL SYSTEM

### Swag Kit for Radial Canopy



Net weight	0,02 kg	Pack	1
Peso netto	0,04 lbs	Colli	

Description Descrizione	Polycarbonate structure Struttura in policarbonato	System Sistema	Code Codice	VAT excluded IVA esclusa
				Euro €
Wall and ceiling anchor for Radial System power cable / Max Ø 7 mm - 0,27" / Max capacity 5 kg - 11,02 lbs	<input type="radio"/> Clear Trasparente	Radial	999A4 00	22,00
Cilindro di decentramento per Sistema Radiale cavo elettrico / Max Ø 7 mm - 0,27" / Portata max 5 kg - 11,02 lbs				



## CATEGORY ACCESSORY

### Back Plate Puzzle

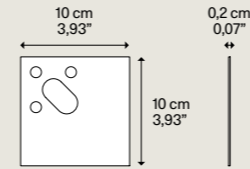

Net weight	0,07 kg	Pack	1
Peso netto	0,15 lbs	Colli	

Description Descrizione	Metal structure Montatura in metallo	System Sistema	Code Codice	VAT excluded IVA esclusa
				Euro €
Optional backplate for Puzzle Wall and Ceiling	<input type="radio"/> Matte White - 9010 Bianco Opaco - 9010	Puzzle Series	14644 00	36,00
Piastra a muro opzionale per Puzzle Parete e Soffitto				



## CATEGORY ACCESSORY

### Kit 4 Lights Line



Net weight	0,37 kg	Pack	1
Peso netto	0,81 lbs	Colli	

Description Descrizione	Metal structure Montatura in metallo	System Sistema	Code Codice	VAT excluded IVA esclusa
				Euro €
Extra Kit for decentralizing suspension with single power cable	<input type="radio"/> Matte White - 9016 Bianco Opaco - 9016	Line voltage cluster suspension lamps	999A00 1000	77,00
Kit extra per decentrare sospensioni con cavo elettrico portante	<input type="radio"/> Matte Black - 9005 Nero Opaco - 9005		999A00 2000	77,00



## CATEGORY ACCESSORY

### Kit Steel

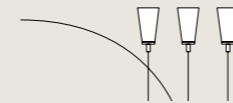





Net weight	0,05 kg	Pack	1
Peso netto	0,11 lbs	Colli	







Description Descrizione	Metal structure Montatura in metallo	System Sistema	Code Codice	VAT excluded IVA esclusa
				Euro €
Extra Kit for decentralizing suspension with steel cable	<input type="radio"/> Chrome Cromo	Kelly Series	999A01 4000	96,00
Kit extra per decentrare sospensioni con funi d'acciaio				











# Glossary





Certifications		
	This certifies that the product complies with the provisions of EC directives.  Attesta la conformità del prodotto alle disposizioni delle direttive comunitarie.	
	EAC marking confirms the compliance of the products with the Eurasian Customs Union.  EAC un marchio che attesta la conformità delle merci alle norme dell'Unione doganale euroasiatica.	







Insulation Class		
	Class I device → connection to the yellow/green protective conductor (ground) is compulsory.  Apparecchio in Classe I → è obbligatoria la connessione al conduttore di protezione giallo/verde (messa a terra).	
	Class II → device in which protection against electric shock is based solely on double and/or reinforced insulation. These devices do not have earthing devices.  Apparecchio in Classe II → nel quale la protezione contro la scossa elettrica si basa unicamente sul doppio isolamento e/o isolamento rinforzato. Questi apparecchi non prevedono dispositivi per la messa a terra.	
	Class III → device in which protection against electric shock is based on a separated extra low voltage (SELV) supply and in which no higher voltages are produced.  Apparecchio in Classe III → Apparecchio in cui la protezione contro la scossa elettrica si basa sull'alimentazione a bassissima tensione di sicurezza (SELV) e in cui non si producono tensioni superiori alla stessa.	



Levels of protection		
	IP → Level of protection. The IP code or ingress protection code indicates how well a device is protected against water and dust. It is defined by the International Electrotechnical Commission (IEC) which classifies and provides a guideline to the degree of protection provided by mechanical casings and electrical enclosures against intrusion, dust, accidental contact, and water.  IP → Il codice IP è un parametro definito dallo standard internazionale IEC 60529 (pubblicato dalla Commissione elettrotecnica internazionale), che classifica e valuta il grado di protezione fornito da involucri meccanici e quadri elettrici contro l'intrusione di particelle solide (quali parti del corpo e polvere) e l'accesso di liquidi.	
	An IP20 rating means the product is touchproof and will be resistant to dust or objects that are over 12 mm in size.  Il grado di protezione IP20 significa che il prodotto è touchproof e resistente alle particelle di polvere o a oggetti di dimensioni superiori a 12 mm.	
	An IP44 rating means that your product will be protected from solid particles that are over 1 mm in size and from low velocity sprays of water from every direction.  Il grado di protezione IP44 significa che il prodotto è protetto da particelle solide di dimensioni superiori a 1 mm e da spruzzi d'acqua a bassa velocità provenienti da ogni direzione.	
	An IP54 rating means that your product will be protected against contamination from limited amounts of dust and other particles. Additionally, you can be confident that it will be protected from water sprays from all directions.  Il grado di protezione IP54 significa che il prodotto è protetto dalla contaminazione di quantità limitate di polvere e altre particelle. Inoltre, è garantita la protezione dagli spruzzi d'acqua provenienti da tutte le direzioni.	
	An IP65 Rating means the product has the highest level of dust protection, and is able to withstand low-pressure water jets from all directions.  La classificazione IP65 significa che il prodotto ha il massimo livello di protezione dalla polvere ed è in grado di resistere a getti d'acqua a bassa pressione provenienti da tutte le direzioni.	
	Products with an IP67 Rating are waterproof due to their high levels of both solid and water ingress.  I prodotti con classificazione IP67 sono impermeabili grazie agli elevati livelli di resistenza all'ingresso di acqua e solidi.	

Dimming		
	Dimmable with TRIAC phase-cut dimmers (trailing edge).  Dimmerabile con variatore a taglio di fase TRIAC.	
	Dimmable with DALI dimmers.  Dimmerabile con dimmer DALI.	
	Dimmable with 0-10V Dimmers.  Dimmerabile con dimmer 0-10V.	
	Dimmer on the cord included.  Dimmer sul cavo incluso.	
	Dim-to-Warm integrated dimmer.  Dim-to-Warm dimmer integrato.	
	Dimmable with ON/OFF Dimming.  Dimmerabile con dimmerazione continua ON/OFF.	

Dimming		
	Controllable with DALI dimmers (non included).  Controllabile con dimmer DALI (non inclusi).	
	Touch integrated dimmer.  Touch dimmer integrato.	

EU Energetic Label	Voltage					
	Energy efficiency classes (with a scale from A to G). It indicates the Energy efficiency class of a product.  Classi di efficienza energetica (con una scala da A a G). Indica la classe di efficienza energetica di un prodotto.	Voltage of the lamp.  Tensione dell'apparecchio.				

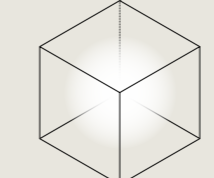
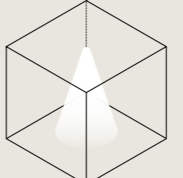
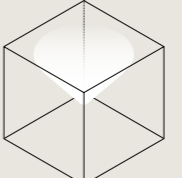
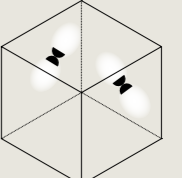
Category					
					
Cluster suspension Sospensione cluster	Suspension Sospensione	Wall Parete	Ceiling Soffitto	Table Tavolo	Floor Terra
					
System Sistema					

Type of light				
				
Diffused light Luce diffusa	Diffused symmetric light Luce simmetrica diffusa	Indirect light Luce indiretta	Adjustable light Luce orientabile	Focused light Luce focalizzata

# Ecodesign Regulation

**1**

The LED-only light source contained in this fixture must only be replaced by the manufacturer, its support service or similarly qualified personnel.

La sorgente luminosa, esclusivamente LED, contenuta in questo apparecchio deve essere sostituita solo dal costruttore o dal suo servizio di assistenza o da personale altrettanto qualificato.

**2**

The LED driver contained in this fixture must only be replaced by the manufacturer, its support service or similarly qualified personnel.

Il driver LED contenuto in questo apparecchio deve essere sostituito solo dal costruttore o dal suo servizio di assistenza o da personale altrettanto qualificato.

PAGE	PRODUCT NAME	CATEGORY	KELVIN	ENERGY CLASS	ECODESIGN	
P. 003	Axia	Suspension lamp	2700 K 3000 K	D	1	2
P. 039	A-Tube Nano	Cluster suspension lamp	2700 K 3000 K	D	1	2
P. 070	A-Tube Nano Swing	Recessed ceiling lamp	2700 K 3000 K	D	1	2
P. 042	A-Tube Nano Duo	Cluster suspension lamp	2700 K	D	1	2
P. 072	Aile	Wall lamp	2700 K 3000 K	E	1	
P. 095	Blow	Table lamp	2700 K	C	1	2
P. 072	Bugia	Ceiling lamp	2700 K 3000 K	F	1	
P. 042, 096	Cono di Luce	Cluster suspension lamp, Table lamp	2700 K	B	1	2
P. 092	Croma	Floor lamp	FROM 2200 K TO 3200 K	E	1	2
P. 102	DOUBLEZERO7	System	2700 K 3000 K	-	1	2
P. 097	Easy Peasy	Cordless table lamp	FROM 2200 K TO 2700 K	D	1	
P. 005	Elara	Suspension lamp	2700 K	D + E	1	2
P. 005	Elara	Suspension lamp	3000 K	D + F	1	2
P. 094	Hover	Floor lamp, Table lamp	2700 K	C	1	
P. 006, 043	IVY	Cluster suspension lamp, Suspension lamp, Central cluster suspension lamp	2700 K	D	1	2
P. 006, 043	IVY	Cluster suspension lamp, Suspension lamp, Central cluster suspension lamp	3000 K	C	1	2
P. 044	Jefferson	Cluster suspension lamp	2700 K	D	1	2
P. 046	Kelly Cluster	Cluster suspension lamp	2700 K	C	1	2
P. 074	Laser	Wall lamp	2700 K 3000 K	E	1	
P. 124	MAP	System	2700 K 3000 K	C	1	2
P. 075	Nautilus	Wall lamp	2700 K 3000 K	F	1	
P. 075	Nautilus Dim-to-Warm	Wall lamp	FROM 2200 K TO 2700 K	E	1	2
P. 076	Nautilus Mini	Wall lamp	2700 K 3000 K	G	1	
P. 076	Nautilus	Ceiling lamp	2700 K 3000 K	F	1	
P. 077	Nautilus Spot	Ceiling lamp	2700 K 3000 K	F	1	
P. 010	Non Random	Suspension lamp	2200 K 2700 K 3000 K	C	1	2
P. 046	Nostalgia	Cluster suspension lamp	2700 K	C	1	2
P. 048	Oblò	Cluster suspension lamp	2700 K 3000 K	D	1	2
P. 077	Pin-Up	Wall lamp, Ceiling lamp	2700 K 3000 K	E	1	

PAGE	PRODUCT NAME	CATEGORY	KELVIN	ENERGY CLASS	ECODESIGN	
P. 079	Puzzle	Wall lamp, Ceiling lamp	2700 K 3000 K	E	1	
P. 080	Puzzle Mega	Wall lamp, Ceiling lamp	2700 K 3000 K	C	1	2
P. 078	Puzzle Round	Wall lamp, Ceiling lamp	2700 K 3000 K	E	1	
P. 049	Rain	Cluster suspension lamp	2700 K 3000 K	C	1	2
P. 050	Random	Cluster suspension lamp	2700 K 3000 K	D	1	2
P. 051	Random Five	Cluster suspension lamp	2700 K 3000 K	D	1	2
P. 012	Random Cloud	Suspension lamp	2700 K 3000 K	D	1	2
P. 052	Random Solo	Cluster suspension lamp	2700 K 3000 K	D	1	2
P. 020	Random Stick	Suspension lamp	2700 K 3000 K	D	1	2
P. 086	Shift	Wall lamp	2700 K 3000 K	D	1	2
P. 034	Sky-Fall	Suspension lamp	2700 K	E	1	2
P. 034	Sky-Fall	Suspension lamp	3000 K	D	1	2
P. 035	Sky-Fall Round	Suspension lamp	2700 K	E	1	2
P. 035	Sky-Fall Round	Suspension lamp	3000 K	D	1	2
P. 058	Spider	Cluster suspension lamp	2700 K 3000 K	C	1	2
P. 083	Spider	Ceiling lamp	2700 K 3000 K	F	1	
P. 032	Tidal	Suspension lamp	2700 K 3000 K	C	1	2
P. 084	Tidal	Ceiling lamp	2700 K 3000 K	B	1	2

# DALI/PUSH to TRIAC Signal Converter

CATEGORY ACCESSORY

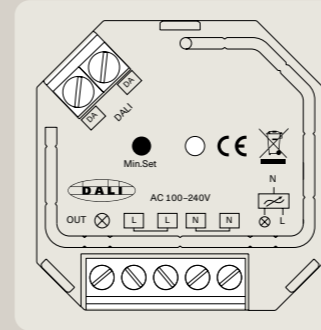

Description Descrizione	DALI Consumption Consumo DALI	Sizes Dimensioni	Code Codice	Euro €
<b>Input Voltage</b> 100-240 VAC	2 mA max	Length 45,5 mm Width 45 mm Height 20,3 mm	999A02 00	123,00
<b>Output Voltage</b> 100-240 VAC				
<b>Output Current</b> 1,8 A max				

VAT excluded  
IVA esclusa

PAGE	PRODUCT NAME	CATEGORY	MAX CONNECTABLE PRODUCTS TO ONE CONVERTER
P. 003	Axia	Suspension lamp	6
P. 039	A-Tube Nano	Cluster suspension lamp	25
P. 070	A-Tube Nano Swing	Ceiling lamp	25
P. 042	A-Tube Nano Duo	Cluster suspension lamp	25
P. 072	Aile	Wall lamp	12
P. 072	Bugia Single	Ceiling lamp	13
P. 073	Bugia Double	Ceiling lamp	6
P. 073	Bugia Triple	Ceiling lamp	4
P. 074	Bugia Mega	Ceiling lamp	4
P. 042	Cono di Luce	Cluster suspension lamp	20
P. 096	Cono di Luce	Table lamp	20
P. 005	Elara	Suspension lamp	6
P. 006, 043	IVY	Cluster suspension lamp, Suspension lamp, Central cluster suspension lamp	25
P. 044	Jefferson	Cluster suspension lamp	25
P. 046	Kelly Cluster	Cluster suspension lamp	18
P. 074	Laser	Wall lamp	12
P. 124	MAP	System	2
P. 075	Nautilus Dim-to-Warm	Wall lamp	8
P. 075	Nautilus	Wall lamp	8
P. 076	Nautilus Mini	Wall lamp	16
P. 076	Nautilus	Ceiling lamp	16
P. 077	Nautilus Spot	Ceiling lamp	20
P. 010	Non Random	Suspension lamp	18
P. 046	Nostalgia	Cluster suspension lamp	11
P. 048	Oblò	Cluster suspension lamp	18
P. 077	Pin-Up	Wall lamp, Ceiling lamp	25
P. 079	Puzzle single square	Wall lamp, Ceiling lamp	12
P. 079	Puzzle double square	Wall lamp, Ceiling lamp	6
P. 078	Puzzle Round single	Wall lamp, Ceiling lamp	12
P. 078	Puzzle Round double	Wall lamp, Ceiling lamp	6

PAGE	PRODUCT NAME	CATEGORY	MAX CONNECTABLE PRODUCTS TO ONE CONVERTER
P. 080	Puzzle Mega small	Wall lamp, Ceiling lamp	6
P. 080	Puzzle Mega large	Wall lamp, Ceiling lamp	5
P. 049	Rain	Cluster suspension lamp	11
P. 050	Random	Cluster suspension lamp	25
P. 051	Random Five	Cluster suspension lamp	18
P. 012	Random Cloud	Suspension lamp	1
P. 052	Random Solo 10, 12, 14, 18	Cluster suspension lamp	25
P. 056	Random Solo 23, 28	Cluster suspension lamp	25
P. 020	Random Stick short	Suspension lamp	11
P. 022	Random Stick medium	Suspension lamp	11
P. 024	Random Stick long	Suspension lamp	9
P. 026	Random Stick XL	Suspension lamp	9
P. 086	Shift small	Wall lamp	9
P. 086	Shift large	Wall lamp	5
P. 034	Sky-Fall	Suspension lamp	12
P. 035	Sky-Fall Round	Suspension lamp	12
P. 058	Spider	Cluster suspension lamp	11
P. 083	Spider	Ceiling lamp	20
P. 032	Tidal	Suspension lamp	4
P. 084	Tidal 45	Ceiling lamp	6
P. 084	Tidal 60	Ceiling lamp	4
P. 085	Tidal 75	Ceiling lamp	3
P. 039	A-Tube	Suspension lamp, Ceiling lamp	
P. 007, 044	JIM	Cluster suspension lamp, Suspension lamp	
P. 008	Kelly	Suspension lamp	
P. 037	Volum	Cluster suspension lamp, Suspension lamp, Wall lamp, Ceiling lamp, Table lamp, Floor lamp	

The wattage of retrofit LED bulbs must not exceed 200W. Make sure to install only dimmable bulbs.

La potenza delle lampadine LED retrofit non deve superare i 200W. Assicurarsi di montare solo lampadine dimmerabili.

# Extended dimming solutions for low-voltage products **NOT INCLUDED**

## Soluzioni di dimmerazione estese per prodotti a bassa tensione **NON INCLUSO**

The suggested drivers are compatible with our lamps but not included. Lodes does not assume any responsibility /guarantee for their installation.

I driver proposti sono compatibili con le nostre lampade ma non inclusi nelle certificazioni. Lodes non si assume nessuna responsabilità/garanzia sulla loro installazione.

PRODUCT NAME	DRIVER VF (V)	DRIVER OPERATIONAL (mA)	LED POWER (W)	SUGGESTED DRIVER	MAX PRODUCTS SERIES WIRING	DRIVER POSITION	TYPE OF DIMMING
Axia	24VDC	24VDC	24	Meanwell mod. XLC-60-24-DA2S	2*	Remote	DALI-PUSH
Kelly Cluster							
Nostalgia							
Non Random	20	350 max	6,9	TCI mod. ATON 30/250-700 DALI Meanwell mod. LCM-40DA Meanwell mod. LCM-40BLE	2 4 4	Remote	DALI-PUSH DALI-PUSH CASAMBI-PUSH
Oblò							
Rain							
Spider – Cluster suspension lamp							
Random Five	15	350 max	5	TCI mod. Aton 30/250-700 DALI Meanwell mod. LCM-40DA Meanwell mod. LCM-40BLE	3 6 6	Remote	DALI-PUSH DALI-PUSH CASAMBI-PUSH
Random Solo 12							
Random Solo 14	3	350 max	1	TCI mod. ATON 30/250-700 DALI Meanwell mod. LCM-40DA Meanwell mod. LCM-40BLE	18 32 32	Remote	DALI-PUSH DALI-PUSH CASAMBI-PUSH
Random Solo 18							
A-Tube Nano Duo	6	350 max	2	TCI mod. ATON 30/250-700 DALI Meanwell mod. LCM-40DA Meanwell mod. LCM-40BLE	9 16 16	Remote	DALI-PUSH DALI-PUSH CASAMBI-PUSH
A-Tube Nano							
IVY							
Jefferson	9	350 max	3	TCI mod. ATON 30/250-700 DALI Meanwell mod. LCM-40DA Meanwell mod. LCM-40BLE	6 10 10	Remote	DALI-PUSH DALI-PUSH CASAMBI-PUSH
Random Solo 23							
Random Solo 28							
Random	9	350 max	3	TCI mod. ATON 30/250-700 DALI Meanwell mod. LCM-40DA Meanwell mod. LCM-40BLE	6 10 10	Remote	DALI-PUSH DALI-PUSH CASAMBI-PUSH
Elara	26,8	1050 max	28,1	KGP mod. CC44W700-1050 DALI TCI mod. Professionale DALI 38	1 1	Canopy	DALI-PUSH DALI-PUSH

PRODUCT NAME	DRIVER VF (V)	DRIVER OPERATIONAL (mA)	LED POWER (W)	SUGGESTED DRIVER	MAX PRODUCTS SERIES WIRING	DRIVER POSITION	TYPE OF DIMMING
Tidal 45	24	550 max	27	KGP mod. CC15W100-700 DALI NFC (2 pcs)	1	Built-in	DALI-PUSH
Tidal 60	46	600 max	28	DIRECT TCI mod. Professionale DALI 38 ERP mod. DAL50W-0850-56-T	1	Built-in	DALI-PUSH DALI
Tidal 60	24	350 max	9	INDIRECT KGP mod. CC10W150-500 DALI NFC EUCHIPS mod. PUP20D-1WMC	1	Built-in	DALI-PUSH DALI-PUSH
Tidal 75	46	700 max	33	DIRECT TCI mod. Professionale DALI 38 ERP mod. DAL50W-0850-56-T	1	Built-in	DALI-PUSH DALI
Tidal 75	24	550 max	13	INDIRECT KGP mod. CC15W100-700 DALI NFC EUCHIPS mod. PUP20D-1WMC	1	Built-in	DALI-PUSH DALI-PUSH
Puzzle Mega Round small Puzzle Mega Square small	46	550 max	25	TCI mod. Professionale DALI 38 ERP mod. DAL50W-0850-56-T	1	Remote	DALI-PUSH DALI
Puzzle Mega Round large Puzzle Mega Square large	46	700 max	33	TCI mod. Professionale DALI 38 ERP mod. DAL50W-0850-56-T	1	Remote	DALI-PUSH DALI
Random Stick short	30	350 max	10,5	EUCHIPS mod. PUP20D-1WMC	1	Canopy	DALI-PUSH
Random Stick medium							
Random Stick long	45	350 max	15,7	EUCHIPS mod. PUP20D-1WMC	1	Canopy	DALI-PUSH
Random Stick XL							

# Light sources power

## Potenza fonti luminose

PAGE	PRODUCT NAME	CATEGORY	TOTAL POWER DRAW	LED QUANTITY & POWER	TOTAL LED POWER
P. 003	Axia	Suspension lamp	30 w	16× 1,5 w	24 w
P. 039	A-Tube Nano	Cluster suspension lamp	5 w	1× 3 w	3 w
P. 070	A-Tube Nano Swing	Recessed ceiling lamp	5 w	1× 3 w	3 w
P. 042	A-Tube Nano Duo	Cluster suspension lamp	4 w	2× 1 w	2 w
P. 072	Aile	Wall lamp	16 w	2× 8 w	16 w
P. 095	Blow	Table lamp	4,5 w	1× 4,5 w	4,5 w
P. 072	Bugia Single	Ceiling lamp	15 w	1× 15 w	15 w
P. 073	Bugia Double	Ceiling lamp	30 w	2× 15 w	30 w
P. 073	Bugia Triple	Ceiling lamp	45 w	3× 15 w	45 w
P. 074	Bugia Mega	Ceiling lamp	45 w	3× 15 w	45 w
P. 042	Cono di Luce	Cluster suspension lamp	10 w	1× 7 w	7 w
P. 096	Cono di Luce	Table lamp	7,5 w	1× 7,5 w	7,5 w
P. 092	Croma	Floor lamp	42 w	1× 42 w	42 w
P. 097	Easy Peasy	Cordless table lamp	5 w	1× 5 w	5 w
P. 005	Elara	Suspension lamp	32 w	18 w + 9 w	27 w
P. 094	Hover	Floor lamp, Table lamp	6,5 w	1× 6,5 w	6,5 w
P. 006, 043	IVY	Cluster suspension lamp, Suspension lamp, Central cluster suspension lamp	5 w	1× 3 w	3 w
P. 044	Jefferson	Cluster suspension lamp	5 w	1× 3 w	3 w
P. 007, 044	JIM	Cluster suspension lamp, Suspension lamp	25 w		
P. 046	Kelly Cluster	Cluster suspension lamp	11 w	1× 7 w	7 w
P. 074	Laser	Wall lamp, Ceiling lamp	16 w	1× 16 w	16 w
P. 124	MAP TRIAC	System	50 w	7,5 w	7,5 w
P. 124	MAP DALI	System	70 w	7,5 w	7,5 w
P. 075	Nautilus Dim-to-Warm	Wall lamp	22 w	2× 7 w	14 w
P. 075	Nautilus	Wall lamp	24 w	2× 12 w	24 w
P. 076	Nautilus Mini	Wall lamp	12 w	1× 12 w	12 w
P. 076	Nautilus	Ceiling lamp	12 w	1× 12 w	12 w
P. 077	Nautilus Spot	Ceiling lamp	10 w	1× 10 w	10 w
P. 010	Non Random	Suspension lamp	11 w	1× 7 w	7 w
P. 046	Nostalgia	Cluster suspension lamp	11 w	1× 7 w	7 w

PAGE	PRODUCT NAME	CATEGORY	TOTAL POWER DRAW	LED QUANTITY & POWER	TOTAL LED POWER
P. 048	Oblò	Cluster suspension lamp	11 w	1× 7 w	7 w
P. 077	Pin-Up	Wall lamp, Ceiling lamp	8 w	1× 8 w	8 w
P. 079	Puzzle single square	Wall lamp, Ceiling lamp	16 w	1× 16 w	16 w
P. 079	Puzzle double square	Wall lamp, Ceiling lamp	32 w	2× 16 w	32 w
P. 078	Puzzle Round single	Wall lamp, Ceiling lamp	16 w	1× 16 w	16 w
P. 078	Puzzle Round double	Wall lamp, Ceiling lamp	32 w	2× 16 w	32 w
P. 080	Puzzle Mega small	Wall lamp, Ceiling lamp	30 w	3× 8 w	25 w
P. 080	Puzzle Mega large	Wall lamp, Ceiling lamp	38 w	4× 8 w	33 w
P. 049	Rain	Cluster suspension lamp	11 w	1× 7 w	7 w
P. 050	Random	Cluster suspension lamp	5 w	3× 1 w	3 w
P. 051	Random Five	Cluster suspension lamp	10 w	1× 5 w	5 w
P. 012	Random Cloud 7 Lights	Suspension lamp	35 w	7× 3 w	21 w
P. 114	Random Cloud 14 Lights	Suspension lamp	70 w	14× 3 w	42 w
P. 116	Random Cloud 19 Lights	Suspension lamp	95 w	19× 3 w	57 w
P. 118	Random Cloud 23 Lights	Suspension lamp	115 w	23× 3 w	69 w
P. 052	Random Solo 10, 12, 14, 18	Cluster suspension lamp	3 w	1× 1 w	1 w
P. 056	Random Solo 23, 28	Cluster suspension lamp	5 w	1× 3 w	3 w
P. 020	Random Stick short	Suspension lamp	17,5 w	3× 2 w + 4× 1 w	10 w
P. 022	Random Stick medium	Suspension lamp	17,5 w	3× 2 w + 4× 1 w	10 w
P. 024	Random Stick long	Suspension lamp	22 w	3× 3 w + 6× 1 w	15 w
P. 026	Random Stick XL	Suspension lamp	22 w	3× 3 w + 6× 1 w	15 w
P. 086	Shift small	Wall lamp	19,5 w	1× 16 w	16 w
P. 086	Shift large	Wall lamp	36 w	1× 32,5 w	32,5 w
P. 034	Sky-Fall	Suspension lamp	15,5 w	2× 6 w	12 w
P. 035	Sky-Fall Round	Suspension lamp	15,5 w	2× 6 w	12 w
P. 058	Spider	Cluster suspension lamp	11 w	1× 11 w	11 w
P. 083	Spider	Ceiling lamp	10 w	1× 10 w	10 w
P. 032	Tidal	Suspension lamp	40 w	16,5 w + 16,5 w	33 w
P. 084	Tidal 45	Ceiling lamp	30 w	27 w	27 w
P. 084	Tidal 60	Ceiling lamp	48 w	28 w + 9 w	37 w
P. 085	Tidal 75	Ceiling lamp	55 w	33 w + 13 w	46 w

**Art. 1 Recital**  
Unless otherwise provided for in a separate written agreement between the parties, every sale of products of Lodes S.r.l., VAT 02992370276 (hereinafter, “the Seller”) is governed by the following General Conditions of Sale that must be considered as an essential part of this agreement and shall be deemed to have been accepted by the Buyer even though the latter has not signed them. Any clause unilaterally added by the Buyer in the documentation signed by it and/or in its correspondence, being against or in any case in addition to the general conditions or to those specific expressly approved in writing by the Seller, shall be deemed as not written and shall be of no effect.

**Art. 2 Completion of the sale, quantities and prices**  
The sale is deemed to be completed once the Seller gives the written order confirmation also by fax and/or email or when deliveries are commenced in cases where the immediate delivery of the supply is requested, also in consideration of changes occurred and then accepted by the customer. The Buyer may cancel the order, only in writing, no later than 24 hours after receipt of the order confirmation sent by the Seller. The prices agreed are understood for products delivered ex works of the Seller and do not include services and accessory charges (such as VAT, special packaging, transport and installation costs, and/or assemblages and so on).

**Art. 3 Delivery, risk transfer and transport**  
Products are delivered to the Buyer at the Seller's plant or at another place indicated in writing by the Seller, and the risk transfer takes place with the delivery of the goods to the first carrier or Buyer in the events of collection of goods directly carried out by the latter. The products always travel at the Buyer's sole risk also when the carrier is selected and appointed by the Seller, being the latter freed from all responsibilities after having delivered the products to the carrier, this delivery is deemed to all effects being carried out directly by the said Buyer. The delivery terms agreed are to be understood as indicative. If the Seller is responsible for delay of delivery for a period of up to 60 days, the Buyer is not entitled either to refuse the supply or to request the termination of the agreement and/or the compensation for any damages. If the delay in delivery exceeds 60 days, the Buyer is entitled to request – by registered letter – the cancellation of the order and the reimbursement of the advances if paid. In any event, the Seller shall not be liable for and/or direct and indirect damages of any nature and for any reason due to the delay or the failure to carry out the supply.

**Art. 4 Reservation of title**  
The Buyer acquires property rights over the goods with the full payment of the price invoiced of the supplies but it takes the risks thereof as of the delivery.

**Art. 5 Products features and conditions of use**  
Unless otherwise expressly agreed in writing by the parties, the conditions for using of the products are those communicated or in any case resulting from the drawings and technical specifications of the Seller, if any, or as described in the website [www.lodes.com](http://www.lodes.com) in relation to products. The quality levels of products are the standard quality levels of the Sellers, indicated in the relevant specifications as described on the Seller's website. It is always the Buyer's responsibility to identify and notify the Seller of the conditions of use of products before technically defining them. Failing any particular instructions from the Buyer, the Seller considers as usual conditions of use those it considered or described in its designs and technical documentation. Drawings, materials, and colours of the products included in catalogues / website and more generally in all advertising material are indicative. The Seller reserves the right, without notice, to modify the characteristics of its products, as well as their availability. Technical data, images, and information regarding the products are not binding on the Seller, who will not be held responsible for any discrepancies and / or illustrative and / or textual errors. Further product characteristics are contained in the respective technical sheets and/or instruction sheets.

**Art. 6 Warranty**  
The products delivered are covered by a warranty for defects in material and manufacture for a period of 24 months from delivery. The Warranty will be extended for an additional 12 months exclusively if the Buyer places

the order through the B2B portal made available by the Seller. The Seller shall replace the products delivered in this warranty period being faulty due to factory defects or in alternative, at its discretion, pay the Buyer an amount equal to the price already invoiced of the said products, being expressly excluded and waived any other right or claim by the Buyer also as compensation for direct and/or indirect damages or cost repayment borne by it (such as recovery, technical assistance, recalling costs, etc.). The Seller will anticipate the delivery of the replaced product, invoicing it regularly. Successively, when the product arrives to the Seller's warehouse, the latter will credit the amount of the defective product. The transport's costs will be paid by the Seller. Should the defected item be returned in an inadequate non-original packaging, with damages connected to the transport, The Seller will not credit any amount to the Buyer, and it will return the product to the sender at his own expenses. If the replacement was made for alleged defects in material and manufacture, but after the control carried out by the Seller, it is considered (i) unfounded, due to the absence of defects; (ii) further damaged by insufficient packaging in the return transport (iii) spoiled by tampering made by the Buyer, all transportation costs and the entire value of the product will be charged to the latter. Any defectiveness or non-compliance of products shall be reported by the Buyer by writing to the Seller – in order to be valid – within 8 days from receipt of goods; any hidden defects shall be reported by the Buyer by writing to the Seller – always in order to be valid – within 8 days as of the relevant discovery. It being understood that the Seller will not be responsible for any defect even though hidden, being notified in writing, after 24 months of the delivery of goods. Every single product bears the CE marking and meets the essential requirements of all applicable directives and regulations within the European Union. Products marked with the UL and / or ETL label comply with North American standards and have been evaluated, inspected, and certified by a third-party organization authorized to issue the mark.

**Art. 7 Warranty Exclusion**  
The warranty shall not apply in the following cases:  
– defects attributable to the Buyer's negligence and /or use of the products not in accordance with the information and explanations provided in any case by the Seller, the technical documentation, incorrect design, application, installation, or construction of the structures in which the products are installed;  
– aesthetic defects that do not significantly affect the intended use of the product;  
– improper storage, handling and transportation, improper or careless use, including cases where the electrical system or its capacity is not suitable;  
– normal wear and tear of the product or its components and /or normal performance degradation due to usage (e.g. light sources, batteries and/or mechanical parts);  
– defects in the software installed in the product;  
– damages caused by lack of and /or poor maintenance or repair attempts carried out by unqualified individuals and /or not previously authorized by the Seller and/or using non-original spare parts (including electronic power supplies and drivers) or different parts than those indicated by the Seller;  
– damages caused by malfunctions in the power supply network, force majeure events, or in any case circumstances not attributable to defects or faults in manufacturing by the Seller.

In any case, the warranty does not cover:  
– any ancillary costs arising from the repair of the defect (including but not limited to: labor and travel costs for disassembly and reassembly, transportation costs related to the defective product and the repaired product, disposal costs, etc.). Such costs shall be borne by the Buyer;  
– products bearing trademarks of other companies that are distributed by the Seller.

**Art. 8 Buyer's Obligations**  
The Buyer is required to immediately take delivery of the goods given by the Seller to the carrier, or – where otherwise agreed – to timely collect them at the Seller's plant on the date on which the Seller communicates, by any means, that the goods are ready. Where the Buyer delays the collection of the production for a period exceeding 10 days, in addition to the payment of price it shall pay the Seller a proper compensation equal to 2% per day of the price invoiced for storing such products. The Buyer shall carry out the payments normally, in

accordance with the terms and conditions specified in the invoice. For late payments it will be accrued by default without need of further notification interest under Legislative Decree no. 231 / 2002. In the event of payment delays, the Seller is entitled to immediately suspend any supply, even though it has concluded other agreements with the same Buyer. The failure to pay within the terms agreed will cause in any event the loss of favourable terms for the Buyer.

**Art. 9 Replacement of the Product**  
If a product is returned for commercial reasons or for a mistake in the order made by the Buyer or in the event of an order cancellation made more than 24 hours after receipt of the order confirmation, the Seller will retain an amount equal to the 20% of the total price as cost for reconditioning the product. If the returned product had already been used and /or it has been returned in an inadequate original packaging, with consequent transport damages, the Seller will not credit to the Buyer any amount and it will return the product to the sender at his own expenses. Only the articles in the catalogue and in the price list in force at the time of the request will be taken into consideration. Transport's costs are always charged to the Buyer. The repair of damaged products will be authorized only if the damage has been caused by the Buyer. The Buyer, once accepted repair costs, will take care of returning the damaged product to the Seller's warehouse and it will pay the costs of transporting the repaired product.

**Art. 10 Force majeure**  
If the Seller is unable to comply with the agreement due to force majeure or beyond its control events, the deadlines set for the supply are automatically extended for a period in which these effects continue. Where the obstacle to comply with the agreement is longer than 6 months, both parties may request the termination of the agreement and, in such event, the Seller repay the Buyer the advances received, if any, releasing itself from any additional obligation on it.

**Art. 11 Agreement**  
In the event of execution of a specific agreement signed by the parties, the said agreement together with its Annexes provides for and summarizes the obligations validly undertaken by the parties and being binding for them. The fulfilment by the parties will be subject to effective evaluation of the actual performance of the contractual tasks and duties to be carried out in good faith, with honesty and fairness. These General Conditions of Sale shall apply to the agreement, unless otherwise provided in writing by the parties or expressly provided in the said agreement.

**Art. 12 Privacy Policy**  
The Seller will use the data received from the Buyer in accordance with the provisions of the article 13 of EU Regulation 2016/679 of 27 April 2016 (GDPR). For more information are available at the following link: [www.lodes.com/privacy-policy](http://www.lodes.com/privacy-policy).

**Art. 13 Disputes**  
Any dispute which may arise concerning the signing, validity, interpretation, performance, amendment and termination of the agreement or of these General Conditions of Sale will be settled according to principles and rule set forth in Article 14 below.

**Art. 14 Jurisdiction and Applicable Law**  
The Court of Milan, Italy, shall be held exclusively competent, being any other court of competent jurisdiction expressly excluded, and the Italian Law shall be applicable.

**Art. 15 Website**  
These General Conditions of Sale are those indicated on the website [www.lodes.com](http://www.lodes.com) and may be printed and reproduced on paper. The Seller undertakes to update the website [www.lodes.com](http://www.lodes.com) by publishing on it the version of the General Conditions of Sale as amended from time to time.

**Art. 1 Premessa**  
Salvo deroga risultante da apposito accordo scritto tra le parti, ogni compravendita di prodotti di Lodes S.r.l., P.IVA 02992370276 (di seguito: “Venditore”) è regolata dalle seguenti Condizioni Generali di Vendita che costituiscono parte essenziale del contratto e che si intendono pertanto accettate dal Compratore ancorché dallo stesso non sottoscritte. Qualsiasi clausola unilateralmente apposta dal Compratore nei documenti da lui sottoscritti e/o nella sua corrispondenza, che sia contraria o comunque in aggiunta alle seguenti condizioni generali od a quelle speciali espressamente approvate per iscritto dal Venditore, si intende come non scritta ed è priva di ogni effetto.

**Art. 2 Perfezionamento della compravendita, quantitativi e prezzi**  
La compravendita si intende perfezionata con la conferma d'ordine scritta del Venditore anche a mezzo fax e/o posta elettronica o con l'inizio delle consegne per i casi in cui è stata richiesta l'immediata consegna della fornitura anche in presenza di modifiche intervenute e quindi accettate dal cliente. Il Compratore potrà cancellare l'ordine, solo per iscritto, al massimo entro 24 ore dalla ricezione della conferma d'ordine inviata dal Venditore. I prezzi concordati si intendono per prodotti consegnati franco stabilimento del Venditore e non comprendono prestazioni ed oneri accessori (quali IVA, imballo speciale, spese di trasporto, di installazione e/o montaggi e così via).

**Art. 3 Consegna, trasferimento del rischio e trasporto**  
La merce viene consegnata al Compratore presso lo stabilimento del Venditore o in altro sito dallo stesso indicato per iscritto, ed il trasferimento del rischio avviene con la consegna della stessa al primo vettore o al Compratore nelle ipotesi di ritiro della merce da quest'ultimo direttamente eseguita. La merce viaggia sempre a rischio esclusivo del Compratore anche quando il vettore dovesse essere scelto ed incaricato dal Venditore, essendo quest'ultimo liberato da ogni responsabilità con la consegna dei prodotti al vettore, che ad ogni effetto si intende eseguita a mani dallo stesso Compratore. I termini di consegna pattuiti si intendono indicativi. In caso di ritardo nella consegna imputabile al Venditore per un periodo fino a 60 gg il Compratore non ha il diritto di rifiutare la fornitura, né di richiedere la risoluzione del contratto e/o il risarcimento di alcun danno. Se il ritardo nella consegna supera il termine di 60 gg il Compratore ha la facoltà di richiedere – con lettera raccomandata – l'annullamento dell'ordine e la restituzione degli anticipi eventualmente versati. Resta in ogni caso escluso qualsivoglia obbligo del Venditore di risarcimento danni diretti e/o indiretti di qualsiasi natura e per qualsiasi ragione, in dipendenza del ritardo ovvero della mancata esecuzione della fornitura.

**Art. 4 Riserva di proprietà**  
Il Compratore acquista la proprietà della merce solo con il pagamento integrale del prezzo fatturato delle forniture ma ne assume i rischi dal momento della consegna.

**Art. 5 Caratteristiche dei prodotti e condizioni di utilizzo**  
Salvo diverso ed espresso accordo scritto tra le parti, i parametri funzionali dei prodotti sono quelli espressi comunicati o comunque risultanti nei disegni e specifiche tecniche del Venditore se esistenti o su quanto indicato sul sito web [www.lodes.com](http://www.lodes.com) relativamente ai prodotti. I livelli di qualità dei prodotti forniti sono quelli standard del Venditore, evidenziati nelle relative specifiche o su quanto indicato e desumibile sul sito web del Venditore. È onere del Compratore individuare e comunicare al Venditore le condizioni di utilizzo dei prodotti prima della relativa definizione tecnica. In mancanza di indicazioni da parte del Compratore il Venditore considera condizioni di utilizzo quelle di prassi dallo stesso considerate o esplicitate nei propri disegni e documentazione tecnica. I disegni, i materiali ed i colori dei prodotti inseriti sui cataloghi / sito internet e più in generale in tutto il materiale pubblicitario, si intendono a titolo indicativo. Il Venditore, si riserva il diritto, senza alcun preavviso, di modificare le caratteristiche dei propri prodotti, così come la disponibilità degli stessi. I dati tecnici, le immagini e le informazioni riguardo ai prodotti non sono vincolanti per il Venditore, il quale non risponderà per eventuali difformità e/o errori illustrativi e/o testuali. Ulteriori caratteristiche dei prodotti sono contenute nelle relative schede tecniche e/o fogli di istruzione.

**Art. 6 Garanzia**  
I prodotti forniti sono coperti da garanzia per difetti di materiale e/o fabbricazione per un periodo di 24 mesi dalla consegna. La Garanzia si estenderà per ulteriori 12 mesi esclusivamente nel caso in cui il Compratore effettui l'ordine attraverso il portale B2B messo a disposizione dal Venditore. Il Venditore sostituisce i prodotti resi in detto periodo di garanzia e riconosciuti difettosi per vizi d'origine ovvero in alternativa ed a sua scelta accreditata al Compratore una somma pari al prezzo già fatturato dei prodotti stessi, restando espressamente escluso e rinunciato qualsiasi diverso diritto o pretesa del Compratore anche a titolo di risarcimento danni diretti e/o indiretti o di rimborso di costi dallo stesso sostenuti (quali costo di riprese, di assistenza tecnica, di richiamo, ecc.). Il Venditore anticiperà l'invio del prodotto in sostituzione, fatturandolo regolarmente, andando poi ad accreditare l'importo alla riconsegna del prodotto difettoso reso. Le spese di trasporto saranno a carico del Venditore. Qualora l'articolo oggetto del reso venisse riconsegnato in un imballo non originale inadeguato con conseguenti danni da trasporto, il Venditore non accrediterà al Compratore alcun importo e rinverrà al mittente, a sue spese il prodotto. Qualora il reso venisse effettuato per presunti vizi d'origine ma dopo il controllo effettuato dal Venditore lo stesso venisse ritenuto (i) infondato, per assenza di vizi; (ii) ulteriormente danneggiato da insufficiente imballaggio nel trasporto di ritorno (iii) viziato da manomissione posta in essere dal Compratore, verranno addebitati a quest'ultimo tutti i costi di trasporto nonché l'intero valore del prodotto. Eventuali difettosità o non conformità dei prodotti devono essere segnalate dal Compratore per iscritto al Venditore – a pena di decadenza – entro e non oltre 8 gg dalla data di ricevimento della merce; eventuali difetti occulti devono essere segnalati dal Compratore per iscritto al Venditore – sempre a pena di decadenza – entro 8 gg dalla relativa scoperta. Resta inteso che il Venditore non sarà responsabile per alcun vizio ancorché occulto, comunicato per iscritto, oltre 24 mesi dalla consegna della merce. Ogni singolo prodotto riporta la marcatura CE e soddisfa i requisiti essenziali di tutte le direttive e normative cogenti all'interno dell'Unione Europea. I prodotti indicati con il marchio UL e/o ETL soddisfano i requisiti delle norme Nord Americane e sono stati valutati, ispezionati e certificati presso ente terzo preposto al rilascio del marchio.

**Art. 7 Esclusione della Garanzia**  
La garanzia non opera in caso di:  
– difetti imputabili a negligenza del Compratore e/o ad impiego dei prodotti non conforme con le informazioni e le spiegazioni in ogni caso fornite dal Venditore, alla documentazione tecnica, ad errata progettazione, applicazione, montaggio o fabbricazione delle strutture ove gli stessi sono installati;  
– difetti estetici che non influiscono in maniera rilevante sull'utilizzo a cui è destinato il prodotto;  
– errato magazzino, movimentazione e trasporto, ad uso improprio od incauto, anche in caso di impianto elettrico e portata dello stesso non idonea;  
– normale usura del prodotto o dei suoi componenti e/o normale peggioramento delle prestazioni a causa dell'utilizzo (es. sorgenti luminose, batterie e/o parti meccaniche);  
– difetti del software installato nel prodotto;  
– danni causati da mancata e/o cattiva manutenzione o tentativi di riparazione eseguiti da soggetti non qualificati e / o non preventivamente autorizzati dal Venditore e/o tramite pezzi di ricambio (inclusi alimentatori elettronici e drivers) non originali o comunque diversi da quelli indicati dal Venditore;  
– danni provocati da malfunzionamenti della rete di alimentazione, eventi di forza maggiore o comunque da circostanze che non possano ricollegarsi a difettosità o vizi di produzione da parte del Venditore.

In ogni caso la garanzia non copre:  
– tutte le spese accessorie che scaturiscono in seguito alla riparazione del vizio (a titolo esemplificativo e non esaustivo: le spese di manodopera e di trasporto per smontaggio e rimontaggio, il costo del materiale relativo al prodotto affetto da vizi e del prodotto riparato, i costi di smaltimento, ecc.). Tali spese saranno a carico del Compratore;  
– i prodotti, con marchio di aziende diverse, che il Venditore commercializza.

**Art. 8 Obblighi del Compratore**  
Il Compratore è tenuto a prendere immediatamente

in consegna i prodotti affidati dal Venditore al vettore, ovvero – se diversamente concordato – a puntualmente ritirarli presso lo stabilimento del Venditore alla data di comunicazione di merce pronta che potrà avvenire con ogni mezzo da parte del Venditore. Ove il Compratore ritardi il ritiro dei prodotti per un periodo superiore a 10 gg, oltre al pagamento del prezzo deve corrispondere al Venditore un adeguato compenso pari al 2% al giorno dell'importo fatturato per il magazzino degli stessi. Il Compratore deve effettuare i pagamenti normalmente, con le modalità e nei termini precisati in fattura. Sui ritardati pagamenti decorreranno, di pieno diritto e senza necessità di costituzione in mora, gli interessi di cui al D.lgs. n. 231/2002. In caso di ritardo dei pagamenti il Venditore ha diritto a sospendere immediatamente ogni fornitura, anche se dipendente da altri contratti con lo stesso Compratore. Il mancato pagamento nei termini pattuiti comporta in ogni caso la decadenza del Compratore dal beneficio del termine.

**Art. 9 Resi**  
In caso di reso commerciale o in caso di reso per errore del Compratore ovvero in caso di annullamento dell'ordine avvenuto oltre le 24 ore dalla ricezione della conferma d'ordine, il Venditore tratterà un importo pari al 20% minimo del totale a titolo di costo di ricondizionamento dell'articolo. Qualora l'articolo oggetto del reso fosse già stato utilizzato e/o venisse riconsegnato in un imballo non originale inadeguato, con conseguenti danni da trasporto, il Venditore non accrediterà al Compratore nessun importo e rinverrà al mittente, a sue spese, il reso. Verranno presi in considerazione solamente gli articoli presenti nel catalogo e nel listino in vigore al momento della richiesta. Le spese di trasporto sono sempre a carico del Compratore. I resi per riparazione vanno autorizzati solo se la causa del danno è dipesa dal Compratore che dopo aver accettato il costo di riparazione si occuperà a proprie spese di rispedire l'articolo danneggiato in sede e si accollerà poi i costi relativi al trasporto del prodotto riparato.

**Art. 10 Forza maggiore**  
Qualora il Venditore sia impossibilitato a rispettare il contratto per cause di forza maggiore o comunque indipendenti dalla sua volontà, i termini previsti per l'esecuzione della fornitura sono automaticamente prorogati per un periodo equivalente al perdurare degli effetti di tali cause. Qualora la causa impeditiva continui per più di 6 mesi entrambe le parti possono chiedere la risoluzione del contratto ed in tal caso il Venditore restituisce al Compratore gli anticipi eventualmente ricevuti, con esclusione di ogni e qualsiasi onere ulteriore a suo carico.

**Art. 11 Contratto**  
In caso di sottoscrizione di apposito contratto lo stesso con i suoi allegati contiene e riassume le obbligazioni validamente assunte dalle parti e per esse vincolanti. L'adempimento delle parti sarà oggetto di valutazione dell'effettiva esecuzione dei compiti e doveri contrattuali, da effettuarsi in buona fede, onestà e con equità. Le presenti Condizioni Generali di Vendita si applicheranno al contratto salvo deroga risultante da atto scritto o in esso contratto esplicitamente prevista.

**Art. 12 Trattamento dei Dati Personali**  
Il Venditore utilizzerà i dati ricevuti dal Compratore conformemente alle disposizioni vigenti in materia di Privacy secondo l'art. 13 del Regolamento Europeo 2016/679 (GDPR). Maggiori informazioni sono disponibili al seguente link: [www.lodes.com/it/privacy-policy](http://www.lodes.com/it/privacy-policy).

**Art. 13 Controversie**  
Qualora dovesse verificarsi una qualsivoglia controversia avente ad oggetto la formazione, validità, interpretazione, esecuzione, modifica e risoluzione del contratto o delle presenti Condizioni Generali di Vendita, questa sarà risolta secondo i principi e le regole indicate nell'articolo 14 che segue.

**Art. 14 Foro competente e legge applicabile**  
Foro esclusivamente competente sarà quello di Milano con esplicita esclusione di ogni altro foro alternativamente competente, e la legge applicabile quella italiana.

**Art. 15 Sito Web**  
Le presenti Condizioni Generali di Vendita, sono quelle risultanti sul sito web [www.lodes.com](http://www.lodes.com) e sono stampabili e riproducibili su supporto cartaceo. Il Venditore si impegna ad aggiornare il sito web [www.lodes.com](http://www.lodes.com) mediante la pubblicazione sullo stesso della versione di Condizioni Generali di Vendita di volta in volta modificata.

Head Offices & Showroom

Lodes – via Pialoi 32,  
30020 Marcon, Venice – Italy  
T +39 041 45 69 266  
General information  
info@lodes.com

Lodes USA LLC  
560 Springfield Avenue, Suite B  
Westfield, NJ 07090 – USA  
D 201 903 0020  
usa@lodes.com

Lodes Milan Showroom

via della Moscova 33,  
Cortile della Seta  
20121 Milano (MI) – Italy  
T +39 02 4940 0999  
milano@lodes.com

Lodes Flagships

Lodes Paris – Novaluce  
131 rue du Faubourg  
Saint Honoré,  
75008 Paris 8e – France  
T +33 (0) 1 42 89 03 18  
paris@lodes.com

Lodes Cologne  
Design Post Köln  
Deutz-Mülheimer-Str. 22a  
50679 Köln – Germany

*Lodes* products were made using specific processing techniques and treatments, aimed at creating unique results. Any differences between individual items are therefore designed to ensure that every single product is special and unique.

I prodotto *Lodes* sono stati realizzati con particolari lavorazioni e trattamenti al fine di ottenere risultati unici. Per tale ragione, eventuali differenze da pezzo a pezzo sono volte a garantire specialità ed unicità ad ogni singolo prodotto.

